

Izaña Atmospheric Research Center



Activity Report 2017-2018

**Joint publication of State Meteorological Agency (AEMET)
and World Meteorological Organization (WMO)**

WMO/GAW Report No. 247



WORLD
METEOROLOGICAL
ORGANIZATION



GLOBAL
ATMOSPHERE
WATCH



GOBIERNO
DE ESPAÑA

VICEPRESIDENCIA
CUARTA DEL GOBIERNO

MINISTERIO
PARA LA TRANSICIÓN ECOLÓGICA
Y EL RETO DEMOGRÁFICO

AEMET
Agencia Estatal de Meteorología

Cover photograph: Izaña Atmospheric Observatory

Citation:

Cuevas, E., Milford, C., Bustos, J. J., García, O. E., García, R. D., Gómez Peláez, A. J., Guirado Fuentes, C., Marrero, C., Prats, N., Ramos, R., Redondas, A., Reyes, E., Rivas Soriano, P. P., Rodríguez, S., Romero Campos, P. M., Torres, C. J., Schneider, M., Yela, M., Belmonte, J., del Campo Hernández, R., Almansa, F., Barreto, A., López Solano, C., Basart, S., Terradellas, E., Werner, E., Afonso, S., Bayo, C., Berjón, A., Carreño, V., Castro, N. J., China, N., Cruz, A. M., Damas, M., De Ory Ajamil, F., García, M. I., Gómez Trueba, V., Hernández, C., Hernández, Y., Hernández Cruz, B., León Luis, S. F., López Fernández, R., López Solano, J., Parra, F., Rodríguez, E., Rodríguez Valido, M., Sálamo, C., Sanromá, E., Santana, D., Santo Tomás, F., Sepúlveda, E., and Sosa, E.: Izaña Atmospheric Research Center Activity Report 2017-2018. (Eds. Cuevas, E., Milford, C. and Tarasova, O.), State Meteorological Agency (AEMET), Madrid, Spain and World Meteorological Organization (WMO), Geneva, Switzerland, WMO/GAW Report No. 247, 2020.

For more information, please contact:

Izaña Atmospheric Research Center
Headquarters: Calle La Marina, 20. Santa Cruz de Tenerife
Tenerife, 38001, Spain
Tel.: +34 922 151 718
Fax: +34 922 574 475
E-mail: ciai@aemet.es
<http://izana.aemet.es>

Edited by:

Ministerio para la Transición Ecológica y el Reto Demográfico
Agencia Estatal de Meteorología (AEMET)
Headquarters: Calle Leonardo Prieto Castro, 8
28071 - Madrid (España)
www.aemet.es

NIPO: 666-20-010-X
<https://doi.org/10.31978/666-20-010-X>

© World Meteorological Organization and AEMET, 2020

The right of publication in print, electronic and any other form and in any language is reserved by WMO. Short extracts from WMO publications may be reproduced without authorization, provided that the complete source is clearly indicated. Editorial correspondence and requests to publish, reproduce or translate this publication in part or in whole should be addressed to:

Chairperson, Publications Board
World Meteorological Organization (WMO)
7 bis, avenue de la Paix
P. O. Box 2300
CH-1211 Geneva 2, Switzerland
Tel.: +41 (0) 22 730 84 03
Fax: +41 (0) 22 730 80 40
E-mail: publications@wmo.int

NOTE

The designations employed in WMO publications and the presentation of material in this publication do not imply the expression of any opinion whatsoever on the part of WMO concerning the legal status of any country, territory, city or area, or of its authorities, or concerning the delimitation of its frontiers or boundaries.

The mention of specific companies or products does not imply that they are endorsed or recommended by WMO in preference to others of a similar nature which are not mentioned or advertised.

The findings, interpretations and conclusions expressed in WMO publications with named authors are those of the authors alone and do not necessarily reflect those of WMO or its Members.

This publication has been issued without formal editing.



Izaña Atmospheric Research Center

Activity Report 2017-2018

Prepared by:

E. Cuevas¹, C. Milford¹, J. J. Bustos¹, O. E. García¹, R. D. García^{1,2}, A. J. Gómez Peláez¹, C. Guirado Fuentes^{1,3}, C. Marrero¹, N. Prats¹, R. Ramos¹, A. Redondas¹, E. Reyes¹, P. P. Rivas Soriano¹, S. Rodríguez¹, P. M. Romero Campos¹, C. J. Torres¹, M. Schneider⁴, M. Yela⁵, J. Belmonte⁶, R. del Campo Hernández⁷, F. Almansa^{1,8}, A. Barreto^{1,8}, C. López Solano⁹, S. Basart¹⁰, E. Terradellas¹¹, E. Werner¹¹, S. Afonso¹, C. Bayo¹, A. Berjón^{1,4,12}, V. Carreño¹, N. J. Castro¹, N. Chinae^{8,12}, A. M. Cruz¹, M. Damas¹, F. de Ory Ajamil¹, M. I. García^{1,13}, V. Gómez Trueba², C. Hernández¹, Y. Hernández¹, B. Hernández Cruz¹³, S. F. León Luis¹, R. López Fernández¹, J. López Solano^{1,12}, F. Parra¹⁴, E. Rodríguez¹, M. Rodríguez Valido¹³, C. Sálamo¹, E. Sanromá¹, D. Santana Díaz^{8,15}, F. Santo Tomás¹, E. Sepúlveda¹ and E. Sosa¹

Editors:

Emilio Cuevas¹, Celia Milford¹ and Oksana Tarasova¹⁶

¹ Izaña Atmospheric Research Center, State Meteorological Agency (AEMET), Tenerife, Spain

² Air Liquide, Tenerife, Spain

³ Atmospheric Optics Group, Valladolid University, Valladolid, Spain

⁴ Institute for Meteorology and Climate Research, Karlsruhe Institute of Technology (KIT), Karlsruhe, Germany

⁵ National Institute for Aerospace Technology (INTA), Torrejón de Ardoz, Madrid, Spain

⁶ Universidad Autónoma de Barcelona (UAB), Barcelona, Spain

⁷ State Meteorological Agency (AEMET), Madrid, Spain

⁸ Cimel Electronique, Paris, France

⁹ SIELTEC, La Laguna, Tenerife, Spain

¹⁰ Barcelona Supercomputing Center, Barcelona, Spain

¹¹ Sand and Dust Storm Warning Advisory and Assessment Regional Centre, AEMET, Spain

¹² TRAGSATEC, Madrid, Spain

¹³ University of La Laguna (ULL), Tenerife, Spain

¹⁴ Inter American University of Puerto Rico, Puerto Rico, USA

¹⁵ LuftBlick Earth Observation Technologies, Innsbruck, Austria

¹⁶ World Meteorological Organization, Geneva, Switzerland

**Joint publication of State Meteorological Agency (AEMET)
and World Meteorological Organization (WMO)**

WMO/GAW Report No. 247



WORLD
METEOROLOGICAL
ORGANIZATION



GLOBAL
ATMOSPHERE
WATCH



GOBIERNO
DE ESPAÑA

VICEPRESIDENCIA
CUARTA DEL GOBIERNO
MINISTERIO
PARA LA TRANSICIÓN ECOLÓGICA
Y EL RETO DEMOGRÁFICO

AEMET

Agencia Estatal de Meteorología

Contents

Foreword.....	vii
1 Organization	1
2 Mission and Background	1
3 Facilities and Summary of Measurements.....	2
4 Greenhouse Gases and Carbon Cycle.....	18
5 Reactive Gases and Ozonesondes.....	27
6 Total Ozone Column and Ultraviolet Radiation.....	35
7 Fourier Transform Infrared Spectroscopy (FTIR).....	46
8 In situ Aerosols.....	55
9 Column Aerosols	61
10 Radiation.....	72
11 Differential Optical Absorption Spectroscopy (DOAS).....	79
12 Water Vapour	84
13 Meteorology	92
14 Aerobiology.....	102
15 Phenology	106
16 ACTRIS.....	109
17 Regional Brewer Calibration Center for Europe (RBCC-E).....	114
18 Sand and Dust Storm Centres.....	122
19 GAW Tamanrasset twinning programme.....	132
20 WMO CIMO Testbed for Aerosols and Water Vapour Remote Sensing Instruments	135
21 Capacity Building Activities	143
22 Scientific Communication	146
23 Publications	152
24 PhD Theses.....	160
25 List of scientific projects	163
26 List of major national and international networks, programmes and initiatives	165
27 Staff	167
28 List of Acronyms	171
29 Acknowledgements	175

Foreword

2019 was an important year for the World Meteorological Organization (WMO). The Eighteenth World Meteorological Congress adopted a historical reform of the WMO constituent bodies to embrace a more comprehensive Earth system approach, with a stronger focus on water resources and the ocean, more coordinated climate activities and a more concerted effort to translate science into services for society. In the new arrangement, the Research Board was tasked with bringing the large international scientific community together to foster an integrated and multidisciplinary research approach to weather, climate, water and the environment and to facilitate the development of all elements of the value chain, from discovery science to serving society, all within the context of the Earth system approach. Current research programmes, namely the Global Atmosphere Watch (GAW) Programme, the World Weather Research Programme (WWRP) and the co-sponsored World Climate Research Programme (WCRP), constitute the building blocks of this multidisciplinary research approach at WMO.

The GAW Programme marked its 30th anniversary this year. GAW provides international leadership in research and capacity development in atmospheric composition observations and analysis from the global to the local scale. The programme promotes high-quality science, enabling the development of a new generation of products and services. An extensive research infrastructure supports the objectives of the programme.

The Izaña Atmospheric Research Center (IARC), which is part of the State Meteorological Agency of Spain (AEMET), represents a centre of excellence in atmospheric science. It manages four observatories in Tenerife, including the high altitude Izaña Observatory, which was inaugurated in 1916 and has since carried out uninterrupted meteorological and climatological observations and become a WMO Centennial Station.

The Izaña Observatory has contributed to the GAW Programme since its inception and is one of 31 GAW Global stations. It performs high-quality, long-term (multi-decade) measurements and analyses of atmospheric greenhouse gases, surface and column ozone, ultraviolet and solar radiation, in situ and column aerosols and selected reactive gases.

IARC supports the GAW quality assurance framework by operating the Regional Brewer Calibration Centre for Europe (RBCC-E), which calibrates Brewer

spectrometers in Europe and North Africa, maintains the Brewer ozone reference and hosts the European Brewer Network (EUBREWNET). In addition, IARC operates a WMO Commission for Instruments and Methods of Observations (CI MO) Testbed for Aerosols and Water Vapour Remote Sensing Instruments. It also supports the World Radiation Center by maintaining one of the World Optical Depth Research and Calibration Center (WORCC) Precision Filter Radiometer reference instruments at the Izaña Observatory. The Izaña Observatory is also one of three AERONET-EUROPE calibration facilities and ensures the calibration of more than 80 AERONET sites.

The Izaña Atmospheric Research Center also plays an important role in supporting international cooperation. For example, it contributes to WWRP as an active member of the WMO Sand and Dust Storm Warning Advisory and Assessment System (SDS-WAS) Regional Center for Northern Africa, Middle East and Europe, focusing its efforts on dust observations and atmospheric processes.

The urgency of actions related to the state of climate and the environment requires that the public and decision-makers have access to the best available science and high-quality atmospheric composition data, and IARC is highly respected for the quality of the data it provides.

It is a pleasure for me to present this report summarizing the many activities of the Izaña Atmospheric Research Center. The Center's leadership in research and development regarding state-of-the-art measurement techniques, calibration and validation, as well as international cooperation have given it an outstanding reputation in weather, climate, hydrology and related environmental issues. I hope that it will inspire Members to consider becoming involved in the GAW Programme and in other WMO research programmes.

Dr Oksana Tarasova

*Chief, Global Atmosphere Watch Programme
Research Department
World Meteorological Organization*





1 Organization

The Izaña Atmospheric Research Center (**IARC**) is part of the Department of Planning, Strategy and Business Development of the State Meteorological Agency of Spain (**AEMET**). AEMET is an Agency of the Spanish Ministry for the Ecological Transition (**MITECO**).

2 Mission and Background

The Izaña Atmospheric Research Center conducts observations and research related to atmospheric constituents that are capable of forcing change in the climate of the Earth (greenhouse gases and aerosols), and may cause depletion of the global ozone layer, and play key roles in air quality from local to global scales. The IARC is an Associated Unit of the Spanish National Research Council (CSIC) through the Institute of Environmental Assessment and Water Research (**IDAEA**). The main goal of the Associated Unit “Group for Atmospheric Pollution Studies” is to perform atmospheric air quality research in both rural and urban environments.

The IARC has contributed to the World Meteorological Organization (WMO) Global Atmosphere Watch (**GAW**) Programme since its establishment in 1989. The GAW Programme marked its 30th anniversary this year. GAW integrates a number of WMO research and monitoring activities in the field of atmospheric environment. The main objective of GAW is to provide data and other information on the chemical composition and related physical characteristics of the atmosphere and their trends. These are required to improve our understanding of the behaviour of the atmosphere and its interactions with the oceans and the biosphere.

The Izaña Atmospheric Research Center also contributes to the Network for the Detection of Atmospheric Composition Change (**NDACC**). NDACC is an international network for monitoring atmospheric composition using remote measurement techniques. Originally, NDACC was created to monitor the physical and chemical changes in the stratosphere, with special emphasis on the evolution of the ozone layer and the substances responsible for its destruction known as Ozone Depleting Substances. The current objectives of NDACC are to observe and to understand the physicochemical processes of the upper troposphere and stratosphere, and their interactions, and to detect long-term trends of atmospheric composition. IARC also makes an important contribution to the WMO through the Global Climate Observing System and through the Commission for Instruments and Methods of Observation (CIMO) as a [WMO-CIMO Testbed for Aerosols and Water Vapour Remote Sensing Instruments](#).

Izaña Atmospheric Observatory was inaugurated in its present location on 1 January 1916, initiating uninterrupted meteorological and climatological observations, which constituted a 103-year record in 2018. In 1984, the observatory became a station of the WMO Background Atmospheric Pollution Monitoring Network (BAPMoN). In 1989, BAPMoN and GO3OS (Global Ozone Observing System) merged in the current Global Atmosphere Watch Programme, of which Izaña Atmospheric Observatory is one of 31 GAW Global stations (Figure 2.1). GAW Global stations serve as centres of excellence and perform extensive research on atmospheric composition change. Izaña Atmospheric Observatory is a key example of such a research facility.



Figure 2.1. WMO GAW Global stations.

3 Facilities and Summary of Measurements

The Izaña Atmospheric Research Center (IARC) manages four observatories in Tenerife (Fig. 3.1, Table 3.1): 1) Izaña Atmospheric Observatory (IZO); 2) Santa Cruz Observatory (SCO); 3) Botanic Observatory (BTO); and 4) Teide Peak Observatory (TPO).



Figure 3.1. Location of IARC observatories on Tenerife.

Table 3.1. IARC observatories.

Observatory	Latitude	Longitude	Altitude (m a.s.l.)
IZO	28.309 °N	16.499 °W	2373
SCO	28.473 °N	16.247 °W	52
BTO	28.411 °N	16.535 °W	114
TPO	28.270 °N	16.639 °W	3555

3.1 Izaña Atmospheric Observatory

The Izaña Atmospheric Observatory (IZO) is located on the island of Tenerife, Spain, roughly 300 km west of the African coast. The observatory is situated on a mountain plateau, 15 km north-east of the volcano Teide (3718 m a.s.l.) (Figs 3.2 and 3.3). The local wind regime at the site is dominated by north-westerly winds. Clean air and clear sky conditions generally prevail throughout the year. IZO is normally above a temperature inversion layer, generally well established over the island, and below the descending branch of the Hadley cell.



Figure 3.3 Izaña Atmospheric Observatory (2373 m) with the volcano Teide (3718 m) to the right of the image.



Figure 3.2. Image of Izaña Atmospheric Observatory.

Consequently, it offers excellent conditions for trace gas and aerosol in situ measurements under “free troposphere” conditions, and for atmospheric observations by remote sensing techniques. The environmental conditions and pristine skies are optimal for calibration and validation activities of both ground-based and space-borne sensors. Due to its geographic location, it is particularly valuable for the investigation of dust transport from Africa to the North Atlantic, long-range transport of pollution from the Americas, and large-scale transport from the tropics to higher latitudes.

The Izaña Atmospheric Observatory facilities consist of three separate buildings: the main building, inaugurated in 1916; the aerosols lab, a small nearby building of the same period which was renamed “Joseph M. Prospero Aerosols Laboratory” on 8 April 2016; and the technical tower, completely rebuilt in early 2000, which hosts most of the instruments. Details of the IZO measurement programme are given in Table 3.2.

The main building is a two-storey building with a total area of 1420 m², which hosts the following facilities: office space, dining room, kitchen, library, conference hall with audio-visual system, meeting room, engine rooms, a mechanical workshop, and an electronics workshop. In addition, there is residential accommodation available for visiting scientists (seven double en-suite rooms).

The technical tower is a seven-storey building with a total area of 900 m². It includes 20 laboratories distributed among the different floors. All the laboratories are temperature-controlled. Details of the IZO Technical Tower facilities are given in Table 3.3.

Table 3.2. Izaña Atmospheric Observatory (IZO) measurement programme.

Parameter	Start date	Present Instrument	Data Frequency
Greenhouse Gases and Carbon Cycle			
CO ₂	Jun 1984	NDIR Licor 7000 (Primary instrument) NDIR Licor 6252 (Secondary instrument) CRDS Picarro G2401	30" 30" 30"
CH ₄	Jul 1984	GC-FID Dani 3800 GC-FID Varian 3800 CRDS Picarro G2401	2 samples/hour 4 samples/hour 30"
N ₂ O	Jun 2007	GC-ECD Varian 3800 Los Gatos Research 913-0015	4 samples/hour
SF ₆	Jun 2007	GC-ECD Varian 3800	4 samples/hour
CO	Jan 2008	GC-RGD Trace Analytical RGA-3 CRDS Picarro G2401 Los Gatos Research 913-0015	3 samples/hour 30"
In situ Reactive Gases			
O ₃	Jan 1987	UV Photometry Teco 49-C (Primary instrument) Teco 49-C (Secondary instrument) Teco 49-I (New Primary instrument)	1' 1' 1'
CO	Nov 2004	Non-dispersive IR abs. Thermo 48C-TL	1'
SO ₂	Jun 2006	UV fluorescence Thermo 43C-TL	1'
NO-NO ₂ -NO _x	Jun 2006	Chemiluminescence Thermo 42C-TL	1'
Total Ozone Column and UV			
Column O ₃	May 1991	Brewer Mark-III #157 (Primary Reference) Brewer Mark-III #183 (for developments) Brewer Mark-III #185 (Travelling Reference)	~100/day ~100/day ~100/day
Spectral UV: 290-365 nm	May 1991	Brewer Mark-III #157 (Primary Reference) Brewer Mark-III # 183 (for developments) Brewer Mark-III #185 (Travelling Reference)	~30' ~30' ~30'
Spectral UV: 290-450 nm	May 1998	Bentham DM 150	Campaigns
Column SO ₂	May 1991	Brewer Mark-III #157 (Primary Reference) Brewer Mark-III # 183 (for developments) Brewer Mark-III #185 (Travelling Reference)	~100/day ~100/day ~100/day
Column O ₃	Oct 2011	Pandora 101 Pandora 121	10'
Column NO ₂	Oct 2011	Pandora 101 Pandora 121	10'

Parameter	Start date	Present Instrument	Data Frequency
Fourier Transform Infrared Spectroscopy (FTIR)			
Greenhouse gases, reactive gases, and O ₃ depleting substances (O ₃ , HF, HCN, HCl, ClONO ₂ , C ₂ H ₆ , HNO ₃ , CH ₄ , CO, CO ₂ , N ₂ O, NO, NO ₂ , H ₂ O, HDO, OCS)	Jan 1999	Fourier Transform Infrared Spectroscopy Bruker IFS 120/5HR (co-managed with KIT)	3 days/week (weather permitting)
	May 2007	Middle infrared (MIR) solar absorption spectra Near infrared (NIR) solar absorption spectra	
Water vapour isotopologues (δ D and δ^{18} O)	Mar 2012	Picarro L2120-I δ D and δ^{18} O Analyser	Continuous (2")
Greenhouse gases, and reactive gases (CO ₂ , CH ₄ , CO, H ₂ O)	May 2018	Fourier Transform Infrared Spectroscopy Bruker EM27/SUN	3 days/week (weather permitting)
In situ aerosols			
Chemical composition of total particulate matter (PM _T)	Jul 1987	High-volume sampler custom built/MVC™/MCZ™ Concentrations of soluble species by ion chromatography (Cl ⁻ , NO ₃ ⁻ and SO ₄ ⁼) and FIA colorimetry (NH ₄ ⁺), major elements (Al, Ca, K, Na, Mg and Fe) and trace elements by ICP-AES and ICP-MS were determined at CSIC	8h sampling at night
PM _{2.5} Chemical composition	Apr 2002	High-volume sampler custom built/MVC™/MCZ™	8h sampling at night
PM ₁₀ Chemical composition	Jan 2005	High-volume sampler custom built/MVC™/MCZ™	8h sampling at night
Number of particles > 3 nm	Nov 2006*	TSI™, UCPC 3025A	1'
Number of particles > 2.5 nm	Dec 2012	TSI™, UCPC 3776	1'
Number of particles > 10 nm	Dec 2012	TSI™, CPC 3010	1'
Size distribution of 10-400 nm	Nov 2006	TSI™, class 3080 + CPC 3772	5'
Size distribution of 0.7-20 μ m	Nov 2006	TSI™, APS 3321	10'
Absorption coeff. 1 λ	Nov 2006	Thermo™, MAAP 5012	1'
Attenuation 7 λ	Jul 2012	Magee™, Aethalometer AE31-HS	1'
Scattering coeff. 3 λ	Jun 2008	TSI™, Integration Nephelometer 3563	1'
PM ₁₀ concentration	Dec 2015	Thermo, BETA 5014i	5'
PM _{2.5} and PM _{2.5-10} concentrations	Dec 2015	Thermo, TEOM 1405DF	6'

*Not operational since June 2017

Parameter	Start date	Present Instrument	Data Frequency
Column aerosols			
AOD and Angstrom at 415, 499, 614, 670, 868, and 936 nm	Feb 1996	YES Multi Filter-7 Rotating Shadow-Band Radiometer (MFRSR)	1'
AOD and Angstrom at 340, 380, 440, 500, 675, 870, 936, 1020 nm	Mar 2003	CIMEL CE318 sun photometer	~ 15'
Fine/Coarse AOD Fine mode fraction	Mar 2003	CIMEL CE318 sun photometer	~ 15'
Optical properties	Mar 2003	CIMEL CE318 sun photometer	~ 1h
AOD and Angstrom during night period	July 2012	CIMEL CE318-T sun-sky-lunar photometer	~ 15' during moon phases
AOD and Angstrom at 368, 412, 500 and 862 nm	July 2001	WRC Precision Filter Radiometer (PFR)	1'
AOD at 769.9 nm	July 1976	MARK-I (at the IAC)	AOD at 769.9 nm
Vertical Backscatter-extinction @523 nm, clouds altitude and thickness	Oct 2018	Micropulse Lidar MPL-3, SES Inc., USA (co-managed with INTA (www.inta.es))	1'
Radiation			
Global Rad. 285-2600nm	Jan 1977	2 CM-21 & CM-11 Kipp & Zonen Pyranom. (in parallel) and EKO MS-801	1'
Global Rad. 300-1100 nm	Feb 1996	YES MFRSR	1'
Estim. Direct Rad.	Feb 1996	YES MFRSR	1'
Direct Rad. 200-4000nm	Aug 2005	2 CH-1 Kipp & Zonen and EKO MS-56 Pyrheliometers	1'
Direct Rad. 200-4000nm	Jun 2014	Absolute Cavity Pyrheliometer PMO6	Calibration campaigns (1')
Spectral direct Radiation	Dec 2016	Spectrorradiometer EKO MS-711	5'
Diffuse Rad.	Feb 1996	YES MFRSR	1'
Diffuse Rad. 285-2600nm	Aug 2005	2 CM-21 Kipp & Zonen Pyranometer (in parallel) and and EKO MS-801	1'
Downward Longwave Rad. 4.5-42 μ m	Mar 2009	2 CG-4 Kipp & Zonen Pyrgeometer (in parallel)	1'
UVB Radiation 315-400nm	Aug 2005	2 Yankee YES UVB-1 Pyranometer (in parallel)	1'
UVA Radiation 280-400nm	Mar 2009	Radiometers UVS-A-T	1'
PAR 400-700nm	Aug 2005	Pyranometer K&Z PQS1	1'
Net Radiation	Nov 2016	Net Radiometer EKO MR-60	1'

Parameter	Start date	Present Instrument	Data Frequency
DOAS (managed by the Spanish National Institute for Aerospace Technology, INTA)			
Column NO ₂	May 1993	UV-VIS DOAS EVA and MAXDOAS RASAS II (INTA's homemade; www.inta.es)	Every ~3' during twilight
Column O ₃	Jan 2000	UV-VIS MAXDOAS RASAS II (INTA's homemade)	Every ~3' during twilight
Column BrO	Jan 2002	UV-VIS MAXDOAS ARTIST-II (INTA's homemade)	Every ~3' during twilight
Tropospheric O ₃	May 2010	UV-VIS MAXDOAS RASAS II (INTA's homemade)	Every ~3' during twilight
Tropospheric NO ₂	May 2010	UV-VIS MAXDOAS RASAS II (INTA's homemade)	Every ~3' during twilight
Tropospheric IO	May 2010	UV-VIS MAXDOAS RASAS II (INTA's homemade)	Every ~3' during twilight
Column HCHO	Jan 2015	UV-VIS MAXDOAS ARTIST II (INTA's homemade)	Every ~3' during twilight
Column Water Vapour			
Precipitable Water Vapour (PWV)	Feb 1996	YES MFRSR-7 Radiometer (941 nm)	1'
PWV	Jul 2008	GPS-GLONASS LEICA receiver	15' (ultra-rapid orbits) and 1h (precise orbits)
Vertical relative humidity	Dec 1963	Vaisala RS-92	Daily at 00 and 12 UTC
PWV	Mar 2003	CIMEL CE318 sun photometer	~ 15'
PWV	Jan 1999	Fourier Transform Infrared Spectroscopy	3 days/week when cloud-free conditions
Meteorology			
Temperature	Jan 1916	THIES CLIMA 1.1005.54.700 3 VAISALA HMP45C (in parallel) VAISALA PTU300 THIES CLIMA 1.0620.00.000 (thermo-hygrograph) CAMPBELL SCIENTIFIC CS215 (Tower top)	1' 1' 1' Continuous 1'
Relative humidity	Jan 1916	THIES CLIMA 1.1005.54.700 3 VAISALA HMP45C (in parallel) VAISALA PTU300 THIES CLIMA 1.0620.00.000 (thermo-hygrograph) CAMPBELL SCIENTIFIC CS215 (Tower top)	1' 1' 1' Continuous 1'
Wind direction and speed	Jan 1916	DELTA OHM Sonic 3D HD2003 Young Wind Monitor HD Alpine 05108-45 Young Wind Monitor HD Alpine 05108-45 Young Wind Monitor HD Alpine 05108-45 (tower Top)	1' 1' 1' 1'

Parameter	Start date	Present Instrument	Data Frequency
Pressure	Jan 1916	SETRA 470 VAISALA PTU 300 BELFORT 5/800AM/1 (Barograph) SETRA 470 (tower top)	1' 1' Continuous 1'
Rainfall	Jan 1916	THIES CLIMA Tipping Bucket THIES CLIMA Tipping Bucket Hellman rain gauge Hellman pluviograph	1' 1' Daily Continuous
Sunshine duration	Aug 1916	KIPP & ZONEN CSD3 Campbell Stokes Sunshine recorder	10' Continuous
Present weather and visibility	Jul 1941	THIES CLIMA drisdrometer BIRAL 10HVJS	10' 10'
Vertical profiles of T, RH, P, wind direction and speed, from sea level to ~30 km altitude	Dec 1963	RS92+GPS radiosondes launched at Güimar automatic radiosonde station (WMO GUAN station #60018) (managed by the Meteorological Centre of Santa Cruz de Tenerife)	Daily at 00 and 12 UTC
Soil surface temperature	Jan 1953	2 THIES CLIMA Pt100 (in parallel)	10'
Soil temperature (20 cm)	Jan 2003	2 THIES CLIMA Pt100 (in parallel)	10'
Soil temperature (40 cm)	Jan 2003	2 THIES CLIMA Pt100 (in parallel)	10'
Atmospheric electric field	Apr 2004	Electric Field Mill PREVISTORM-INGESCO	10"
Lightning discharges	Apr 2004	Boltek LD-350 Lightning Detector	1'
Cloud cover	Sep 2008	Sieltec Canarias S.L. SONA total sky camera	5'
Fog-rainfall	Nov 2009	THIES CLIMA Tipping Bucket with 20 cm ² mesh Hellman rain gauge with 20 cm ² mesh	1' Daily
Sea-cloud cover	Nov 2010	AXIS Camera: West View (Orotava Valley) AXIS Camera: South View (Meteo Garden) AXIS Camera: North View AXIS Camera: East View (Güimar Valley)	5' 5' 5' 5'
Drop size distribution and velocity of falling hydrometeors	May 2011	OTT Messtechnik OTT Parsivel	1'
Aerobiology			
Pollens and spores	Jun 2006	Hirst, 7-day recorder VPPS 2000 spore trap (Lanzoni S.r.l.). Analysis performed with a Light microscope, 600 X at the Laboratori d'Anàlisis Palinològiques, Universitat Autònoma de Barcelona	Continuous (1 h resolution) from April to October
Phenology			
Emergence of the inflorescence, the appearance of flower buds, flowering, and fruit development according to the BBCH code of 7 taxa	Jan 2014	Visual inspection/counting	Weekly during growing season, and monthly the rest of the year

Table 3.3. Izaña Atmospheric Observatory technical tower facilities.

Floor	Facilities	Description
Ground Floor	Mechanical Workshop	33 m ² room with the necessary tools to carry out first-step mechanical repairs.
	Electronics Workshop	25 m ² room equipped with oscilloscopes, power supplies, multimeters, soldering systems, etc. to carry out first-step electronic repairs.
	Heating system	Central heating and hot water 90 kW system.
	Air Conditioning System	Central air conditioning system for labs.
	Engine Room: Backup Generators	General electrical panel and two automatic start-up backup generators (400 kVA and 100 kVA, respectively).
	UPS room	Observatory's main UPS (40 kVA redundant) used for assuring the power of the equipment inside the building and an additional UPS (10 kVA) for the outside equipment.
	Compressor room	Room with clean oil-free air compressors used for calibration cylinders filling. It also contains the general pumps for the East and West sample inlets.
	Warehouse / Central Gas Supply System	30 m ² warehouse authorized for pressure cylinders. Central system for high purity gas (H ₂ , N ₂ , Ar/CH ₄) and synthetic air supply.
	Lift	6-floors. No lift access to roof terrace.
First Floor	Archive room	Archive of bands and historical records.
	Technical equipment warehouse	Spare parts for the Observatory's technical equipment.
	Meeting room	8 person meeting room
Second Floor	Optical Calibration Facility	30 m ² dark room hosting vertical and horizontal absolute irradiance, absolute radiance, angular response, and spectral response calibration set ups.
	T2.1 Laboratory	10 m ² lab with access to West sample inlet.
	T2.2 Laboratory	9 m ² lab with access to East sample inlet.
	T2.3 Laboratory	13 m ² lab hosting Picarro L2120-I δD and δ18O analyser with access to East sample inlet
Third Floor	Greenhouse Gases Laboratories	70 m ² shared in two labs hosting CO ₂ , CH ₄ , N ₂ O, SF ₆ and CO analysers with access to the East and West sample inlets.
Fourth Floor	All purpose laboratories	Three labs with access to the East and West sample inlets.
Fifth Floor	Reactive Gases Laboratory	10 m ² lab hosting NO-NO ₂ , CO, and SO ₂ analysers with access to West sample inlet.
	Communications room	Server room and WIFI connection with Santa Cruz de Tenerife headquarters.
	Brewer Laboratory	20 m ² lab for Brewer campaigns.
Sixth Floor	Surface Ozone Laboratory	10 m ² laboratory hosting surface O ₃ analysers with access to West sample inlet.
	Solar Photometry Laboratory	10 m ² maintenance workshop for solar photometers.
	Spectroradiometer Laboratory	25 m ² laboratory hosting two MAXDOAS and two spectroradiometers connected with optical fibre.
Roof	Instrument Terrace	160 m ² flat horizon-free terrace hosting outdoor instruments, East and West sample-inlets, wind, pressure, temperature and humidity gauges.

On the ground floor of the technical tower, there are two storage spaces, one of them for pressured cylinders (tested and certified at the Canary Islands Regional Council for Industry) and the other one for cylinder filling using oil-free air compressors. This floor also includes the central system for supplying high purity gases (H₂, N₂, Ar/CH₄) and synthetic air to the different laboratories. On the second floor, there is a dark-room with the necessary calibration set-ups for the IZO radiation instruments. On the top of the technical tower there is a 160 m² flat horizon-free terrace for the installation of outdoor scientific instruments that need sun or moon radiation. It also has the East and West sample-inlets which supply the ambient air needed by in situ trace gas analysers set up in different laboratories.

The “Joseph M. Prospero Aerosol Research Laboratory” is a 40 m² building used as an on-site aerosol measurement laboratory. It has four sample-inlets connected to aerosol analysers. For more details, see Section 8. Outside Izaña Atmospheric Observatory there are the following facilities: 1) a 160 m² flat horizon-free platform with communications and UPS used for measurement field campaigns; 2) the meteorological garden, containing two fully-automatic meteorological stations (one of them the SYNOP station and the second one for meteorological research), manual meteorological gauges, a total sky camera, a GPS/GLONAS receiver, a lightning detector, and an electric field mill sensor; and 3) the Sky watch cabin hosting four cameras for cloud observations with corresponding servers. The following sections give further details of some of the facilities located at IZO.

3.1.1 Optical Calibration Facility

The optical calibration facility at IZO has been developed within the framework of the Specific Agreement of Collaboration between the University of Valladolid and the IARC-AEMET: “To establish methodologies and quality assurance systems for programs of photometry, radiometry, atmospheric ozone and aerosols within the atmospheric monitoring programme of the World Meteorological Organization”. The main objective of the optical calibration facility is to perform Quality Assurance & Quality Control (QA/QC) assessment of the solar radiation instruments involved in the ozone, aerosols, radiation, and water vapour programs of the IARC. The eight set-ups available are the following:

- 1) Set-up for the absolute irradiance calibration by calibrated standard lamps in a horizontally oriented position suitable for small radiometers (Fig. 3.4A). The basis of the absolute irradiance scale consists of a set of FEL-type 1000 W lamps traceable to the primary irradiance standard of the Physikalisch-Technische Bundesanstalt (PTB).
- 2) Set-up for the absolute irradiance calibration by calibrated standard lamps in a vertical oriented position suitable for relatively large spectrophotometers (Fig. 3.4B).

The basis of the absolute irradiance scale consists of a set of DXW-type 1000 W lamps traceable to the primary irradiance standard of the PTB.

- 3) Set-up for the absolute radiance calibration by calibrated integrating sphere (Fig. 3.4C). The system is traceable to the AErosol RObotic NETwork (AERONET) standard at the Goddard Space Flight Center (Washington, USA). This set-up is mainly used by Cimel sun-photometers, but other instruments are also calibrated.

- 4) At the end of 2017, in the framework of a competitive scientific infrastructure call of the National Plan for Research, Development and Innovation of Spain, a new integrating sphere was installed at Izaña for AERONET-Europe absolute radiance calibrations as well as optical tests required for QC/QA of reference instruments. The new integrating sphere has a 20 inches diameter, an 8 inches aperture, and 400 W power (Fig. 3.4G). This system is also traceable to the AERONET standard at the Goddard Space Flight Center.

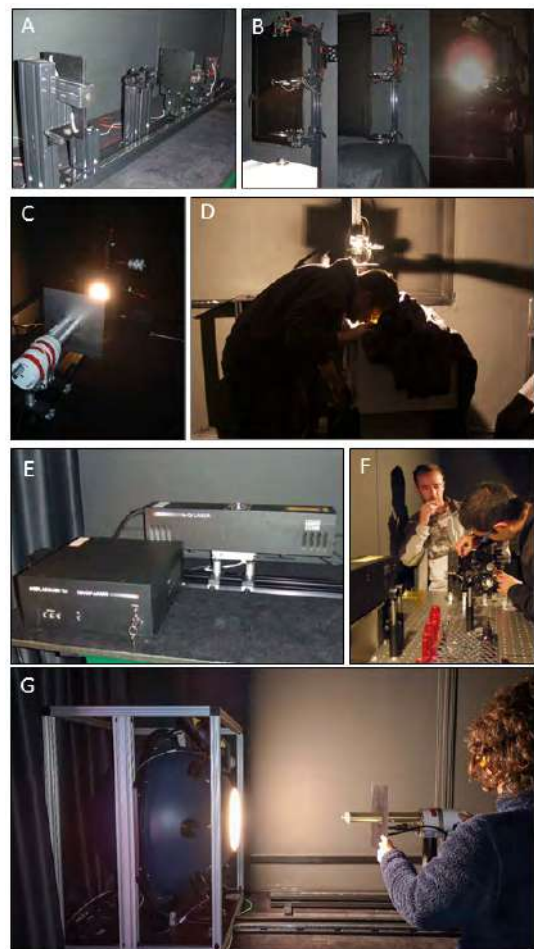

Figure 3.4. Images of the IZO Optical calibration facility. A) Horizontal absolute irradiance calibration set up, B) Three stages of a Brewer irradiance calibration with the vertical set up, C) Absolute radiance calibration of a Cimel CE318, D) Angular response function determination of a Brewer, E) Set up for Slit function determination, F) Alignment of a Brewer spectrophotometer optics and G) Absolute radiance calibration of a Cimel CE318.

5) Set-up for the angular response calibration (Fig. 3.4D). It is used to quantify the deviations of the radiometer's angular response from an ideal cosine response. The relative angular response function is measured rotating the mechanical arm where the seasoned DXW-type 1000 W lamp is located. The rotation over $\pm 90^\circ$ is controlled by a stepper motor with a precision of 0.01° while the instrument is illuminated by the uniform and parallel light beam of the lamp.

6) Set-up for the spectral response calibration. It is used to quantify the spectral response of the radiometer. The light is scattered by an Optronic double monochromator OL 750 within the range 200 to 1100 nm with a precision of 0.1 nm. An OL 740-20 light source positioned in front of the entrance slit acts as radiation source and two lamps, UV (200-400nm) and Tungsten (250-2500nm) are available.

7) Set-up for the slit function determination (Fig. 3.4E). The characterization of the slit function is performed illuminating the entrance slit of the spectrophotometer with the monochromatic light of a VM-TIM He-Cd laser. The nominal wavelength of the laser is 325 nm, its power is 6mW, and its beam diameter is 1.8 mm.

8) Set-up for the alignment of the Brewer spectrophotometer optics (Fig. 3.4F). It is suitable to perform adjustments of the optics without sending the instrument to the manufacturer.

3.1.2 In situ system used to produce working standards containing natural air

GAW requires very high accuracy in the atmospheric greenhouse gas mole fraction measurements, and a direct link to the WMO primary standards maintained by the GAW GHG CCLs (Central Calibration Laboratories), most of which are located at NOAA-ESRL-GMD. To accomplish

these requirements, IARC uses Laboratory Standards prepared (using natural air) and calibrated by NOAA-ESRL-GMD. Indeed, the Laboratory Standards used at IARC are WMO tertiary standards.

However, due to the fact that the consumption of standard and reference gases by the IARC GHG measurement systems is relatively high, an additional level of standard gases (working standards) prepared with natural air is used.

These working standards are prepared at IZO using an in situ system (Fig. 3.5) and then calibrated against the Laboratory Standards using the IARC GHG measurement systems. The system used to fill the high pressure cylinders (up to 120-130 bars) with dried natural air, takes clean ambient air from an inlet located on top of the IZO tower (30 m above ground), and pumps (using an oil-free compressor) it inside the cylinders after drying it (using magnesium perchlorate), achieving a H_2O mole fraction lower than 3 ppm.

Additionally, it is possible to modify slightly the CO_2 mole fraction of the natural air pumped inside the cylinders. To this end, air from a cylinder containing natural air with zero CO_2 mole fraction (prepared using the same system but adding a CO_2 absorber trap) or a tiny amount of gas from a spiking CO_2 cylinder (5% of CO_2 in $N_2/O_2/Ar$) is added to the cylinder being filled, not affecting the CRDS technique. This system is similar to that used by NOAA-ESRL-GMD to prepare WMO secondary and tertiary standards, and it is managed and operated at IZO through a subcontractor (Air Liquide Canarias). The prepared working standards are mainly used in the GHG measurement programme, but some of them are used for other purposes, natural air for a H_2O isotopologue Cavity Ring-Down Spectroscopy (CRDS) analyser located at Teide peak and for a CO NDIR analyser located at SCO.

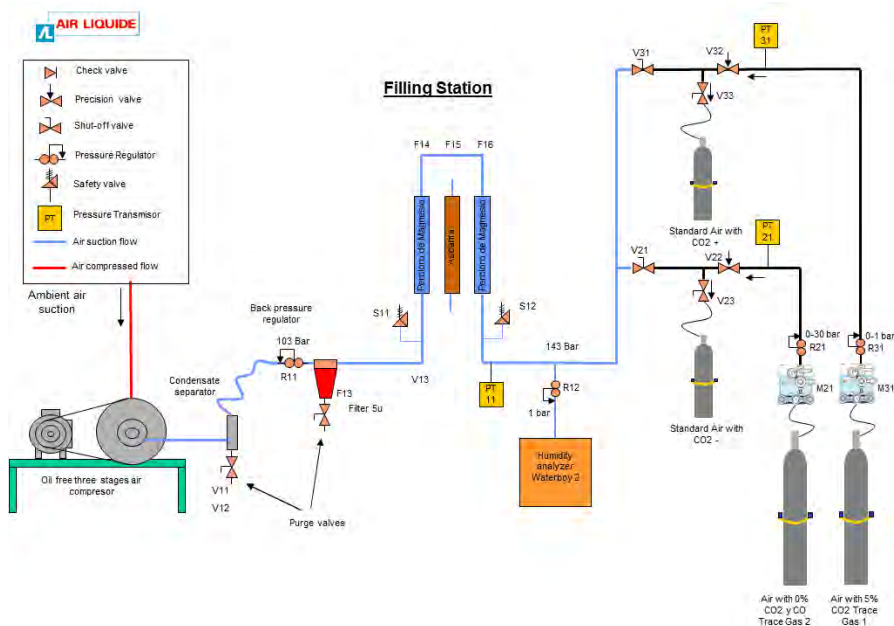

Figure 3.5. In situ system used to produce working standards containing natural air at Izaña Atmospheric Observatory.

3.1.3 Central Gas Supply System

There is a gas central facility located on the IZO tower ground floor for supplying chromatographic gases to the different instruments. This central facility supplies high purity: N_2 (used as carrier gas for the GC-FIDs, and for the IZO H_2O isotopologue CRDS analyser), synthetic air (used as oxidizer in the FIDs, as carrier gas in the GC-RGD, as carrier gas in the IZO H_2O isotopologue CRDS analyser, and as diluting air used in the calibrations of the reactive gas instruments), 95% Ar / 5% CH_4 (used as carrier gas for the GD-ECD), and H_2 (used as combustible in the FIDs). This facility and the chromatographic gases are managed and provided, respectively, by a subcontractor (Air Liquide Canarias). The H_2O isotopologue CRDS analyser located at Teide peak has its own dedicated high purity N_2 supply. The reactive gas analysers located at SCO have their own dedicated high purity synthetic air supply (used as diluting air in the calibrations).

Additionally, other gases (provided by the same subcontractor) are used at IZO: high purity CO_2 for the calibration of an aerosol nephelometer, high purity N_2O for FTIR instrumental line shape monitoring, liquid N_2 to cryocool the FTIR detectors, and calibrated concentrated gas standards in N_2 (19.4 ppm NO and 19.4 ppm NO_x , 1.01 ppm CO, 1.04 ppm CO, 99.9 ppm CO, 102 ppm SO_2 , and 1 ppm SO_2) for the calibration of the instruments of the reactive gases programme.

3.1.4 Modifications and improvements to the IZO facilities carried out in 2017-2018

In 2018, the old power transformation center was renovated and converted into the new Lidar facility (Fig. 3.6) and the Cimel Lidar was installed. A new second power generator (100 KVA) was installed as a backup of the main power generator.



Figure 3.6. New Lidar facility at IZO.

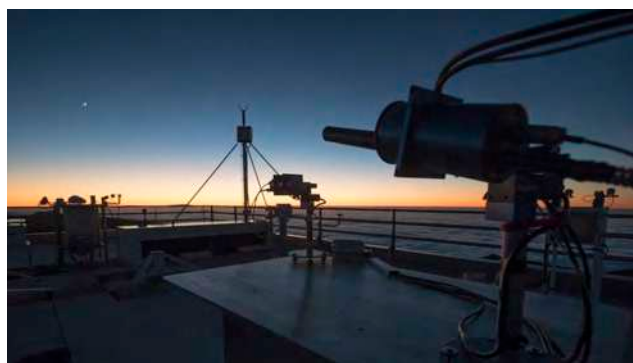

Figure 3.7. Images of IZO Instrument terrace and technical tower.

3.2 Santa Cruz Observatory

The Santa Cruz de Tenerife Observatory (SCO) is located on the roof of the IARC headquarters at 52 m a.s.l. in the capital of the island (Santa Cruz de Tenerife), close by the city harbour (Figs. 3.8 and 3.9). Details of the SCO measurement programme are given in Table 3.4.

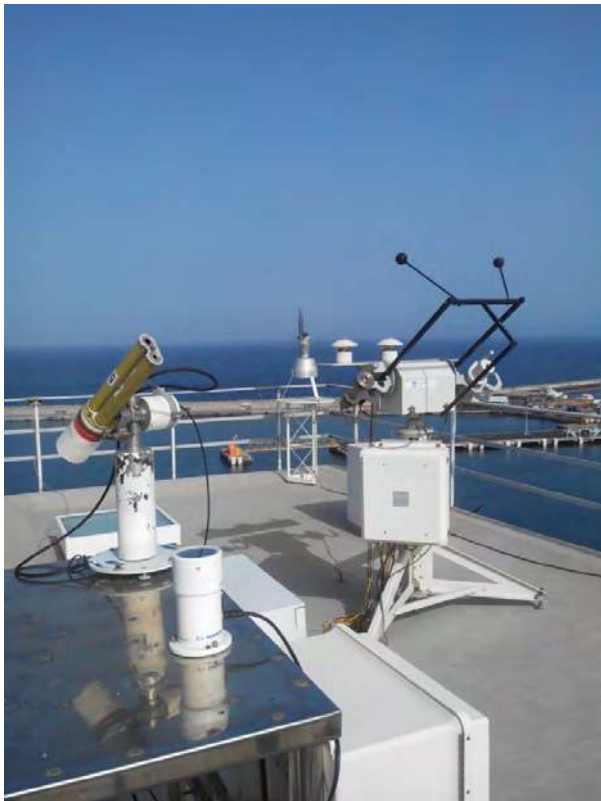

Figure 3.8. Image of Santa Cruz Observatory instrument terrace: ZEN-41-R radiometer (in the foreground), Cimel AERONET photometer, radiation instruments mounted on the sun-tracker and the HIRST pollen sampler (in the background).

This observatory has two main objectives: 1) to provide information of background urban pollution for atmospheric research and interactions with long-range pollution transport driven by trade winds or Saharan dust outbreaks and 2) to perform complementary measurement programmes to those performed at IZO. The IARC headquarters include the following facilities:

- A laboratory for reactive gases (surface O_3 , NO - NO_2 , CO and SO_2).
- A laboratory for micro pulse Lidar (MPL) and ceilometer VL-51.
- A laboratory to dry and weigh filters of high and low volume aerosol samplers.
- A laboratory for the preparation of ozonesondes
- A 25 m² flat horizon-free terrace for radiation instruments and air intakes.



Figure 3.9. Air quality analyzers in the SCO Lab (left), and Ramón Ramos and Pedro Miguel Romero (right) with the Vaisala CL51 ceilometer on the SCO terrace.

3.2.1 Aerosol Filters Laboratory

The Aerosol Filters Laboratory is equipped with an auto-calibration microbalance (Mettler Toledo XS105DU) with a resolution of 0.01 mg, a set of standard weights, and an oven that reaches 300 °C. Filters are weighed after temperature and humidity conditioning following the requirements of the EN-14907 standards. This filter weighing procedure is used for determining the concentrations of TSP, PM_{10} , $PM_{2.5}$ and PM_1 by means of standardized methods. Filters are conditioned to 20 °C and a fixed relative humidity (50% RH for air quality studies and 30% RH for research studies) within a methacrylate chamber, which also contains the balance used for weighing the filters (Fig. 3.10).



Figure 3.10. Aerosol Filters laboratory: temperature and relative humidity controlled chamber.

Table 3.4. Santa Cruz Observatory (SCO) measurement programme.

Parameter	Start date	Present Instrument	Data Frequency
In situ Reactive Gases			
O ₃	Nov 2004	UV Photometry Teco 49-C	1'
CO	Mar 2006	Non-dispersive IR abs. Thermo 48C-TL	1'
SO ₂	Mar 2006	UV fluorescence Thermo 43C-TL	1'
NO-NO ₂ -NO _x	Mar 2006	Chemiluminescence Thermo 42C-TL	1'
Ozone and UV (managed by the AEMET's Special Networks Service at the nearby Met Center)			
Column O ₃	Oct 2000	Brewer Mark-II#033	> ~20/day
Spectral UV	Oct 2000	Brewer Mark-II#033	~30'
SO ₂	Oct 2000	Brewer Mark-II#033	~30'
Column aerosols			
AOD and Angstrom at 340, 380, 440, 500, 675, 870, 936, 1020 nm	Jul 2004	CIMEL CE318 sun photometer	~ 15'
Fine/Coarse AOD	Jul 2004	CIMEL CE318 sun photometer	~ 15'
Vertical Backscatter-extinction @523 nm, clouds alt. and thickness	Nov 2005	Micropulse Lidar MPL-3, SES Inc., USA (co-managed with INTA (www.inta.es)) <i>MPL-3 installed in IZO in Oct 2018</i>	1'
Vertical backscatter-extinction @910 nm, cloud alt. and thickness	Jan 2011	Vaisala CL-51 Ceilometer	1'
Vertical Backscatter-extinction @500 and 800 nm, clouds alt. and thickness (with depolarization channels)	Dec 2015	CIMEL CE376 lidar	1'
Vertical Backscatter-extinction @532 nm, clouds alt. and thickness	May 2018	Micropulse Lidar MPL-4B, provided by NASA Goddard Space Flight Center MPLNET	1'
Radiation			
Global Radiation	Feb 2006	Pyranometer CM-11 Kipp & Zonen	1'
Direct Radiation	Feb 2006	Pyrheliometer EPPLEY	1'
Diffuse Radiation	Feb 2006	Pyranometer CM-11 Kipp & Zonen	1'
UV-B Radiation	Aug 2011	Yankee YES UVB-1 Pyranom. (managed by the AEMET's Special Networks Service at the nearby Met Centre)	1'
Column Water Vapour			
Vertical relative humidity	Dec 1963	Vaisala RS-92	Daily at 00 and 12 UTC
Precipitable Water Vapour (PWV)	Mar 2003	CIMEL CE318 sun photometer	~ 15'
PWV	Jan 2009	GPS/GLONASS GRX1200PRO receiver	15' (ultra-rapid orbits) and 1 h (precise orbits)

PWV (total column) over SCO when cloudless skies Cloud base heights when cloudy skies over SCO	Jun 2014	1 SIELTEC Sky Temperature Sensor (infrared thermometer prototype)	Every 30" during the complete day
Meteorology*			
Vertical profiles of T, RH, P, wind direction and speed, from sea level to ~30 km altitude	Dec 1963	RS92+GPS radiosondes launched at Güimar automatic radiosonde station (WMO GUAN station #60018) (managed by the Meteorological Centre of Santa Cruz de Tenerife)	Daily at 00 and 12 UTC
Temperature	Jan 2002	VAISALA HMP45C	1'
Relative humidity	Jan 2002	VAISALA HMP45C	1'
Wind Direction and speed	Jan 2002	RM YOUNG wind sentry 03002	1'
Pressure	Jan 2002	VAISALA PTB100A	1'
Rainfall	Jan 2002	THIES CLIMA Tipping Bucket	1'
Aerobiology			
Pollens and spores	Oct 2004	Hirst, 7-day recorder VPPS 2000 spore trap (Lanzoni S.r.l.).	Continuous (1 h resolution)

* Meteorological data from Santa Cruz de Tenerife Meteorological Center headquarters, 1 km distant, are also available since 1922.

3.2.2 The Ozonesonde Laboratory

Advanced preparation of the Science Pump Corporation (SPC) ECC ozone sensor (Model ECC-6A), together with digital Vaisala RS92 radiosonde and digital interface, is performed at the Ozonesonde Lab at SCO. Expendables such as radiosondes, interfaces, ozonesondes, ozone solution chemicals, syringes, needles, protection gloves, and triple distilled water are stored in this lab.

A Science Pump Corporation Model TSC-1 Ozonizer/Test Unit is used for ozonesonde preparation. This unit has been designed for conditioning ECC ozonesondes with ozone, and for checking the performance of the sondes prior to balloon release. The Ozonizer/Test Unit is installed inside a hood in which ambient air is passed through an active charcoal filter to destroy ozone and other pollutants (ozone-free air). The volumetric flow of the gas sampling pump of each ECC sonde is individually measured at the Ozonesonde Lab before flight. The pump flow rate of the sonde is measured with a bubble flow meter at the gas outlet of the sensing cell.

On the day before release, two ECC-6A ozonesondes are checked for proper operation and filled with sensing solution. The day of the ozonesonde launching the sensors are transported to BTO ozonesonde launching station (30 km distance) where pre-launch tests are performed at ground including a final double check of the RS-92, and a comparison of surface ozone from ECC-6A with a TECO-49C ozone analyser.

3.3 Botanic Observatory

The Botanic Observatory (BTO) is located 13 km north-east of IZO at 114 m a.s.l. in the Botanical Garden of Puerto de la Cruz (Fig. 3.11). BTO is hosted by the Canary Institute of Agricultural Research (ICIA). The Botanic Observatory includes the following facilities:

- Ozone Sounding Monitoring Laboratory: equipped with a Digicora MW31 receiver with Vaisala METGRAPH data acquisition and processing software and a surface ozone analyser
- Launch container: equipped with a Helium supply system used for ozonesonde balloons filling.

In addition to the ozonesonde measurements, there is a fully equipped automatic weather station (temperature, relative humidity, pressure, precipitation, wind speed and direction), a global irradiance pyranometer and a surface ozone analyser (also used for additional ECC electrochemical sondes ground checking). For details of the BTO measurement programme, see Table 3.5.



Figure 3.11. Image of Botanic Observatory (BTO).

Table 3.5. Botanic Observatory (BTO) measurement programme.

Parameter	Start date	Present Instrument	Data Frequency
Reactive Gases and ozonesondes			
Vertical profiles of O ₃ , PTU, and wind direction and speed, from sea level to ~33 km altitude	Nov 1992	ECC-A6+RS92/GPS radiosondes	1/week (Wednesdays)
Surface O ₃	May 2011	UV Photometry Teco 49-C	1'
Radiation			
Global Radiation	May 2011	Pyranometer CM-11 Kipp & Zonen	1'
Column Water Vapour			
Precipitable Water Vapour (PWV)	Jan 2009	GPS/GLONASS GRX1200PRO receiver	15' (ultra-rapid orbits) and 1 h (precise orbits)
Meteorology			
Temperature	Oct 2010	VAISALA F1730001	1'
Relative humidity	Oct 2010	VAISALA F1730001	1'
Wind direction and speed	Oct 2010	VAISALA WMT700	1'
Pressure	Oct 2010	VAISALA PMT16A	1'
Rainfall	Oct 2010	VAISALA F21301	1'

3.4 Teide Peak Observatory

The Teide Peak Observatory (TPO) is located at 3555 m a.s.l. at the [Teide Cable Car](#) terminal in the Teide National Park (Fig. 3.12). TPO was established as a satellite station of IZO primarily for radiation and aerosol observations at very high altitude. TPO station, together with Jungfraujoch (3454 m a.s.l.) in Switzerland, are the highest permanent radiation observatories in Europe.

This measurement site provides radiation and aerosol information under extremely pristine conditions and in conjunction with measurements at SCO and IZO allows us to study the variation of global radiation, UV-B and aerosol optical depth from sea level to 3555 m a.s.l. In addition to radiation and aerosol measurements, there is a meteorological station and a water vapour isotopologues analyser. Full details of the measurement programme are given in Table 3.6.

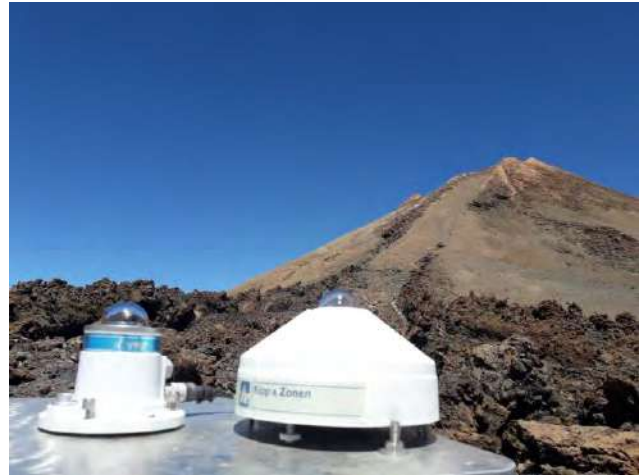

Figure 3.12. Measurements at Teide Peak Observatory.

Table 3.6. Teide Peak Observatory (TPO) measurement programme.

Parameter	Start date	Present Instrument	Data Frequency
Column aerosols			
AOD and Angstrom at 340, 380, 440, 500, 675, 870, 936 and 1020 nm	Jun 1997	CIMEL CE318 sun photometer (Co-managed with the University of Valladolid Atmospheric Optics Group)	~ 15' (during Apr-Oct)
Fine/Coarse AOD Fine mode fraction	Jun 1997	CIMEL CE318 sun photometer (Co-managed with the University of Valladolid Atmospheric Optics Group)	~ 15' (during Apr-Oct)
Radiation			
Global Radiation	Jul 2012	Pyranometer CM-11 Kipp & Zonen	1'
UVB Radiation	Jul 2012	Pyranometer Yankee YES UVB-1	1'
Water vapour			
Water vapour isotopologues (δD and $\delta^{18}O$)	June 2013	Picarro L2120-I δD and $\delta^{18}O$ analyser	2"
Meteorology			
Wind direction and speed	Oct 2011	THIES CLIMA Sonic 2D	1'
Temperature	Aug 2012	VAISALA HMP45C	1'
Relative humidity	Aug 2012	VAISALA HMP45C	1'
Pressure	Aug 2012	VAISALA PTB100A	1'

3.5 Computing Facilities and Communications

The computing facilities and communications form an integral component of all measurement programmes and activities in the Izaña Atmospheric Research Center. In the IARC headquarters there is a temperature controlled room hosting server computers devoted to different automatic and continuous tasks (NAS, modelling, spectra inversion, etc.) for the research groups. Details of the computing facilities are given in Table 3.7.

Table 3.7. IARC computing facilities.

Computing Hardware				
	Storage	Virtualization	Modelling	Total
H.D.	34 TB	12 TB	10 TB	56 TB
Cores	7	28	68	105
RAM	12 GB	56 GB	46 GB	114 GB

The IARC headquarters has internet access through a double optical fibre connection (20 Mb/s) to AEMET headquarters in Madrid, one of them acting as back-up. IZO is real time connected to IARC headquarters through a wifi-radio link (54 Mb/s) of 34 km. A EUMETCast (EUMETSAT's Broadcast System for Environmental Data) reception station is available at SCO. It consists of a multi-service dissemination system based on standard Digital Video Broadcast (DVB) technology. Most of the satellite information is received via this system (see Section 13 for more details). An important communication advance in IZO was the establishment of a connection with the Iris Nova network, which has some of its nodes in the facilities of the Instituto de Astrofísica de Canarias (IAC) Teide Observatory.

3.6 Staff

Activities universal to all measurement programmes such as operation and maintenance of IARC facilities, equipment, instrumentation, communications and computing facilities are made by the following staff:

- Ramón Ramos (AEMET; Head of Scientific instrumentation and infrastructures)
- Enrique Reyes (AEMET; IT development specialist)
- Néstor Castro (AEMET; IT specialist)
- Antonio Cruz (AEMET; IT specialist)
- Rocío López (AEMET; IT specialist)
- Sergio Afonso (AEMET; Meteorological Observer-GAW Technician)
- Concepción Bayo (AEMET; Meteorological Observer-GAW Technician)
- Virgilio Carreño (AEMET; Meteorological Observer-GAW Technician)
- Cándida Hernández (AEMET; Meteorological Observer-GAW Technician)
- Dr Fernando de Ory (AEMET; Meteorological Observer-GAW Technician) left IARC in October 2018

4 Greenhouse Gases and Carbon Cycle

4.1 Main Scientific Goals

The main goal of the Greenhouse Gases and Carbon Cycle programme conducted by IARC is to carry out highly accurate atmospheric long-lived greenhouse gas (GHG) in situ continuous measurements at IZO in order to contribute to the GAW-WMO programme, following the GAW recommendations and guidelines. Additional goals are: 1) to study with precision the long-term evolution of the GHGs in the atmosphere, as well as their daily, seasonal and inter-annual variability; 2) To incorporate continuously technical instrumental improvements and new data evaluation and calibration methodologies in order to reduce uncertainty and improve the accuracy of the GHG measurements; 3) to carry out research to study the processes that control the variability and evolution of the GHGs in the atmosphere; and 4) to contribute to international research and its documentation via recommendations and guidelines.

In addition, since 2017 there has been a growing demand to provide reliable near real time GHG data for data assimilation by atmospheric models, to study the impact of certain large-scale phenomena (e.g. large wild fires), to exchange data with the remote sensing community, and to inform policy makers since GHG information is now an object of great social interest and great media impact. This new paradigm demands an enormous effort and a technical challenge by having to combine the classic evaluation of very precise background data (a task that can take at least 6 months) with the delivery of data of an acceptable quality and minimally validated within a few hours or minutes of being obtained. These new tasks must be incorporated with the same team of technicians and researchers.

4.2 Staff changes

In October 2017, the Programme Head, Dr Ángel Gómez-Peláez, moved to another position within AEMET, after almost 12 years leading this programme. This circumstance conditioned an important part of the programme activity during 2017 and 2018. Enrique Reyes, a physicist with good programming skills, joined the programme learning all the data evaluation procedures of each and every one of the instruments. He also took over the source codes of the software used to process and evaluate the data. In addition, Dr Emilio Cuevas, joined part-time in this programme, coordinating activities related to customer service, being in charge of data submission to the international databases (WDCGG; ObsPack), coordinating external audits and

calibrations, collaborating with international observation programmes (eg, GAW, Integrated Carbon Observation system (ICOS)), and promoting the participation in research projects on GHG and carbon cycle. Ramón Ramos continues the hard work of maintaining and improving the instrumentation of the programme, and Vanessa Gómez collaborates in the calibration tasks.

We take this opportunity to thank sincerely Dr Ángel Gómez-Peláez for the excellent services provided by leading this programme for more than a decade, with great dedication and rigor, and to wish him all the best in his new job.

4.3 Measurement Programme

Table 4.1 gives details of the atmospheric greenhouse gases measurements currently performed at IZO using in situ analysers (owned by AEMET) and some details about the measurement schemes. Details of the in situ measurement systems and data processing can be found in Gomez-Pelaez et al. (2006, 2009, 2011, 2012, 2013, 2014, 2016 and 2017).

Additional information can be found in the last IZO GHG GAW scientific audit reports: Scheel (2009), Zellweger et al. (2009), and Zellweger et al. (2013).

Additionally, weekly discrete flask samples have been collected for the National Oceanic and Atmospheric Administration-Earth System Research Laboratory-Global Monitoring Division Carbon Cycle Greenhouse Gases Group (NOAA-ESRL-GMD CCGG) [Cooperative Air Sampling Network](#) (since 1991). The participation consists of weekly discrete flask sample collection at IZO and subsequent shipping of the samples to NOAA-ESRL-GMD CCGG.



Figure 4.1. IZO Gas Chromatograph measurement system for CH₄, N₂O and SF₆.

Table 4.1. Atmospheric greenhouse gases measured in situ at IZO and measurement schemes used.

Gas	Start Date	Analyser	Model	Ambient air measurement frequency	Reference gas/es and measurement frequency	Reference gas/es calibration frequency
CO ₂	1984	NDIR	Licor 7000 Licor 6252	Continuous Continuous	3 RG every hour 3 RG every hour	Biweekly using 4 LS
CH ₄	1984	GC-FID	Dani 3800 Varian 3800	2 injections/hour 4 injections/hour	1 RG every 30 min 1 RG every 15 min	Biweekly using 2 LS
N ₂ O	2007	GC-ECD	Varian 3800	4 injections/hour	1 RG every 15 min	Biweekly using 5 LS
SF ₆	2007	GC-ECD	Varian 3800	4 injections/hour	1 RG every 15 min	Biweekly using 5 LS
CO	2008	GC-RGD	Tr.An. RGA-3	3 injections/hour	1 RG every 20 min	Biweekly using 5 LS
CO ₂ CH ₄ CO	2016	CRDS	Picarro G2401	Continuous	2 RG every 21 hours to study performance	Every 3-4 weeks using LS
CO N ₂ O	2018	LGR	Los Gatos Research 915-0015	Continuous	2 RG every 4 hours, one as working gas and the other as a target gas	Every 4 weeks using 5 LS

Reference gas/es (RG), Laboratory Standard (LS)

The air inside the flasks has been measured for the following gas specie mole fractions: 1) CO₂, CH₄, CO, and H₂ since 1991; N₂O and SF₆ since 1997 (both sets measured by NOAA/ESRL/GMD CCGG); 2) Isotopic ratios Carbon-13/Carbon-12 and Oxygen-18/Oxygen-16 in carbon dioxide since 1991 (measured by the Stable Isotope Lab of INSTAAR); 3) Methyl chloride, benzene, toluene, ethane, ethene, propane, propene, i-butane, n-butane, i-pentane, n-pentane, n-hexane and isoprene since 2006 (measured by INSTAAR). Figure 4.2 shows the decline of ¹³CO₂ at Izaña Observatory in the period 1991-2018.

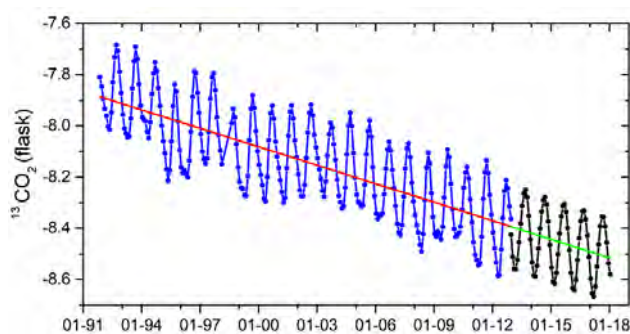

Figure 4.2. ¹³CO₂ data series (1991-2013) from the Stable Isotope Lab of INSTAAR (blue) and simulated data using the NOAA/ESRL/GMD curve fitting methods (black).

Two-week integrated samples of atmospheric carbon dioxide have also been collected for the Heidelberg University (Institute of Environmental Physics, [Carbon Cycle Group](#)) since 1984 to measure the C-14 isotopic ratio in carbon dioxide.

4.4 Summary of remarkable activities during the period 2017-2018

This programme has continued performing continuous high-quality greenhouse gas measurements and annually submitting the data to the WMO GAW World Data Centre for Greenhouse Gases ([WDCGG](#)), where data are publicly available, as well as data summaries (e.g., [WDCGG, 2018](#)).

The complete CO₂ time series is shown in Fig. 4.3. The growth rate of CO₂ throughout the period (1984-2018) is approximately 1.9 ppm/yr. However, a detailed analysis of the growth rate time series of the CO₂ trend curve (not shown here) indicates that the increase in CO₂ is accelerating, and is currently more than 2.1 ppm/yr, significantly higher than the value of 1.8 ppm/yr which was recorded at the beginning of the CO₂ measurements at IZO in 1984.

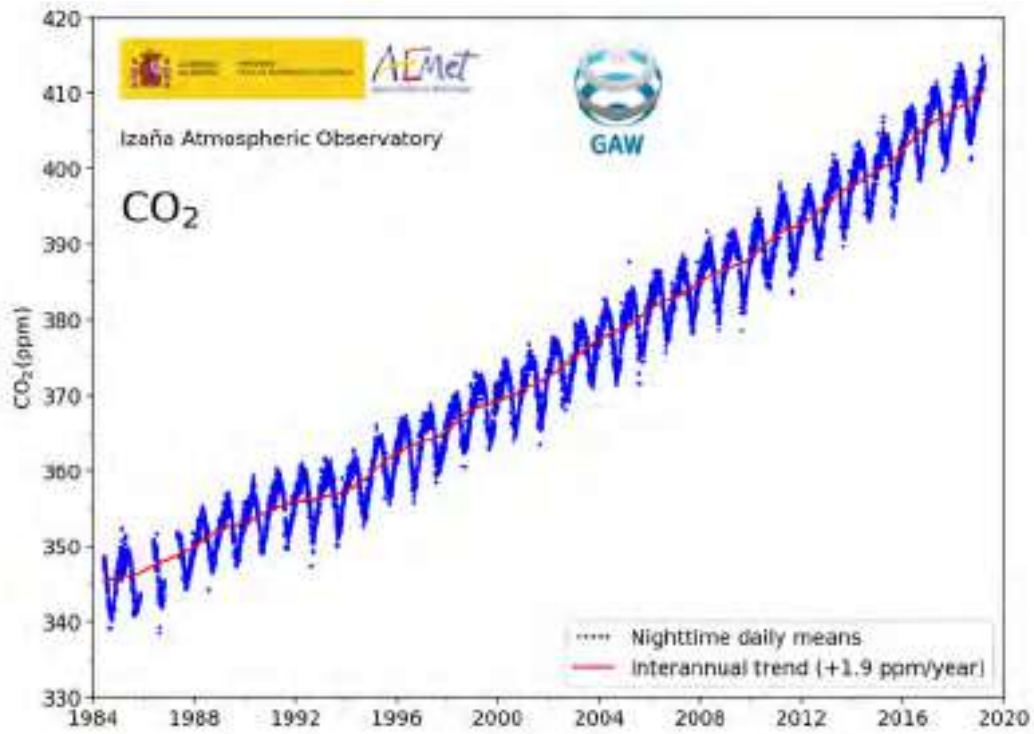

Figure 4.3. Izaña Atmospheric Observatory CO₂ time series (1984-2018).

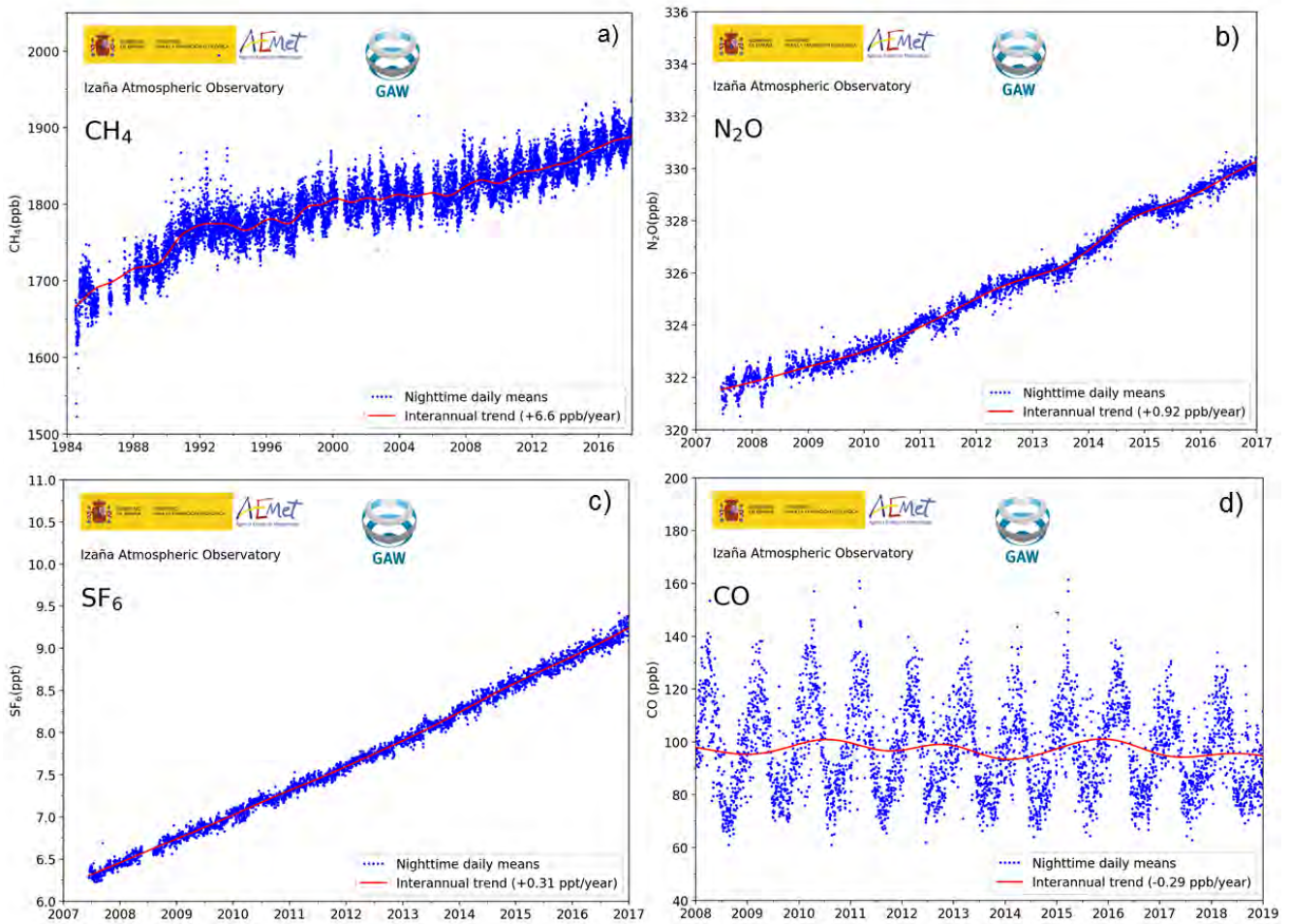

Figure 4.4. Izaña Atmospheric Observatory time series for a) CH₄, b) N₂O, c) SF₆ and d) CO.

The CH₄, N₂O, SF₆ and CO time series at IZO are shown in Fig. 4.4. All the collected data are used for analysis and investigation of the carbon cycle and understanding of the role of anthropogenic and natural factors that control GHG variability. The curve fitting methods applied to the IZO time series are those used by NOAA/ESRL/GMD (Thoning et al., 1989).

IARC has also continued contributing to the data products GLOBALVIEW and OBSPACK led by NOAA-ESRL-GMD CCGG (e.g., Cooperative Global Atmospheric Data Integration Project, 2016), as well as collaborating with the associated CO₂ surface flux inversions CarbonTracker (e.g., CarbonTracker Team, 2016), CarbonTracker Europe and MACC, which follows the procedure described in Chevallier et al. (2010).

During the summer of 2018, a widespread drought developed over Northern and Central Europe. The significant increase in temperature and the reduction of soil moisture have disturbed CO₂ exchanges with terrestrial ecosystems by various mechanisms such as the reduction of photosynthesis, or fires which were particularly important in Sweden at the end of July 2018. For these reasons, ICOS has carried out a study, to which IARC has contributed with updated data, where the resulting perturbation of the seasonal cycle of the atmospheric CO₂ concentrations was characterized.

The former PI of this programme participated in the “19th WMO/IAEA Meeting on Carbon Dioxide, Other Greenhouse Gases, and Related Measurement Techniques (GGMT-2017)” which was held in Dubendorf, Switzerland, on 27–31 August 2017, with a presentation on the implementation of the new Picarro CRDS analyzer (Gomez-Pelaez et al., 2017).

4.4.1 CO₂, CH₄, and CO measurements with CRDS technique at IZO

A part of the work time in this program during this reporting period was dedicated to the implementation of the new Picarro G2401 cavity ring down spectrometer (CRDS) instrument for simultaneous measurement of CO₂, CH₄, CO and H₂O in ambient air samples (Fig. 4.5).



Figure 4.5. CRDS for measuring CO₂, CH₄ and CO at the Izaña Atmospheric Observatory.

At the end of 2015, a CO₂/CH₄/CO Picarro CRD was installed at the Izaña Observatory to improve the Izaña Greenhouse Gases GAW Measurement Programme, and to guarantee the renewal of the instrumentation and the long-term maintenance of this program. The general measurement scheme is shown in Fig. 4.6.

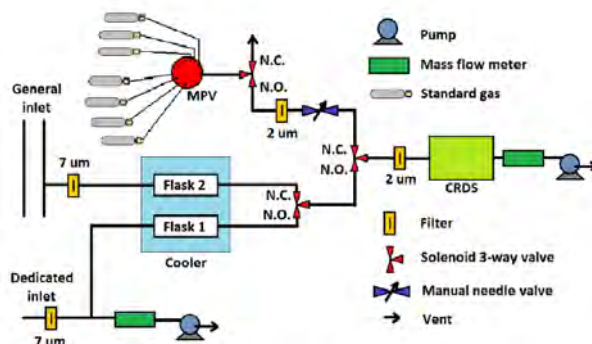

Figure 4.6. Ambient air/gas standard plumbing configuration of the CRDS set up at Izaña Observatory. Reprinted from Gomez-Pelaez et al. (2017).

In this study the results of the CRDS acceptance tests, the raw data processing scheme applied, and the response functions used were tackled. The calibration results, the implemented water vapor correction, the target gas injection statistics, the ambient measurements performed from December 2015 to July 2017, and their comparison with other continuous in situ measurements were also object of a detailed analysis.

The agreement with other in situ continuous measurements showed, most of the time, excellent results for CO₂ and CH₄, but for CO we found it was just outside the GAW 2 ppb objective. It seems the disagreement is not produced by significant drifts in the CRDS CO WMO tertiary standards. The more relevant contributions of this analysis were:

- 1) determination of linear relationships between flow rate, CRDS inlet pressure, and CRDS outlet valve aperture;
- 2) determination of a slight CO₂ correction that takes into account changes in the inlet pressure/flow rate (as well as its stability over the years), and attributing it to the existence of a small spatial inhomogeneity in the pressure field inside the CRDS cavity due to the gas dynamics;
- 3) drift rate determination for the pressure and temperature sensors located inside the CRDS cavity from the CO₂ and CH₄ response function drift trends;
- 4) determination of the H₂O correction for CO by using the raw spectral peak data instead of the raw CO provided by the CRDS, and using a running mean to smooth random noise in a long water-droplet test (12h) before performing the least square fit;
- 5) determination of the existence of a small H₂O dependence in the CRDS flow and of a small spatial inhomogeneity in

the temperature field inside the CRDS cavity, investigating their origin.

A detailed description of this study can be seen in Gomez-Pelaez et al. (2017), the version of the paper in the discussion phase. During the preparation of this report the final version of the paper has also now been published (Gomez-Pelaez et al., 2019)

4.4.2 Implementation of a Los Gatos Research analyzer for simultaneous measurements of N₂O and CO

In 2018, a new analyzer (the Los Gatos Research LGR 913-0015 analyzer), to measure CO and N₂O based on a very innovative technique, was incorporated into the measurement programme. This instrument was acquired thanks to the project entitled “Equipment for the Monitoring and Research of the atmospheric components that cause and modulate climate change at the Izaña GAW (Global Atmospheric Watch) (Tenerife)” (contract: AEDM15-BE-3319). This R+D infrastructure project has been financed by the State Research Agency of the Ministry of Economy, Industry and Competitiveness, in the Call for projects of scientific equipment, co-financed with European Regional Development Fund (ERDF) funds.

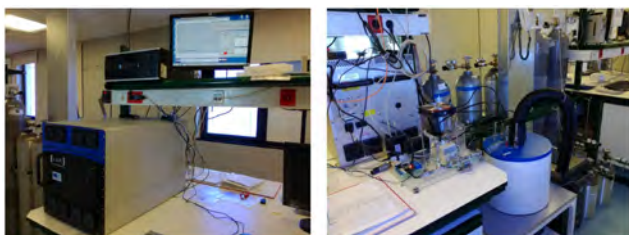

Figure 4.7. Front and rear view of the Los Gatos Research (LGR) CO/N₂O analyser at Izaña Observatory with the new designed plumbing including air samples cooling system.

This instrument is based on a spectroscopic technique with a high quality optical cavity (high reflectivity and optical quality), and low volume, (less than 0.5 liters) that allows very long optical paths due to the multitude of reflections of the infrared light beam (4.6 μm wavelength) that occur within the cavity. The infrared light beam is produced by a Quantum Cascade Laser with adjustable wavelength. The instrument controls with great precision the temperature and pressure inside the optical measuring cavity, said pressure being substantially lower than the ambient.

The analyzer also measures H₂O by taking advantage of spectral lines that are in the range of those used for the measurement of N₂O and CO. The total pre-drying of the air to be analyzed with this instrument is currently required in order to achieve the accuracy required by the GAW program for N₂O measurement. This is achieved circulating the air through a cryogenization system at -60°C.

The calibration system consists of the measurement of a tank containing CO and N₂O GAW world references

provided by the NOAA Earth System Research Laboratory in Boulder, Colorado, USA, once a month. Additionally, and in order to correct and verify possible small diurnal variations, a “working-tank” and a “target-tank”, both with known CO and N₂O concentrations are measured every 4 hours.

This analyzer is now part of the GAW Greenhouse Gases and Carbon cycle programme, and the primary instrument for CO and N₂O measurements at the Izaña Observatory. This equipment complies with the requirements of the ICOS European Research Infrastructure Consortium (ERIC). At this moment, this instrument is the only instrument accepted by ICOS for N₂O measurements.

4.5 Participation in international cooperative scientific studies

4.5.1 A decadal inversion of CO₂ using the Global Eulerian–Lagrangian Coupled Atmospheric model (GELCA): sensitivity to the ground-based observation network

The head of the IARC Greenhouse and Carbon Cycle program at Izaña Observatory actively participated in this scientific study that tackles the atmospheric CO₂ assimilation system of the Global Eulerian-Lagrangian Coupled Atmospheric (GELCA) transport model of the National Institute for Environmental Studies (NIES) of Japan (for more details see Shirai et al., 2017).

An atmospheric transport model consists in a numerical model that given an initial spatial distribution of concentration of a given trace gas (e.g., CO₂) in the atmosphere, computes the time evolution of the concentration of this trace gas in the atmosphere solving a set of partial differential equations. These equations take into account that the trace gas is transported by the wind field, but also dispersed due to turbulence and convection. There are also surface (oceanic and land) sources and sinks of the trace gas to be taken into account by the model. There might be also volumetric sinks within the atmosphere in case of trace gases that react chemically in the atmosphere, but this is not the case for CO₂.

The surface sources and sinks of trace gases are currently characterized by high uncertainty due to limitations of emission inventories, vegetation models and ecosystem trace gas flux measurements among other factors. Using a transport model and atmospheric measurements of trace gas concentration in many stations, the surface sources and sinks can be better constrained performing an “Inversion” technique. The procedure is as follows: 1) the a priori surface fluxes are used in a forward run of the transport model; 2) the simulated trace gas concentrations simulated for each time step are compared with the measured concentrations; 3) from these differences in concentration, the improvements that need to be applied to the surface

fluxes to minimize those differences can be deduced; and therefore, a more accurate a posteriori value for the surface fluxes can be obtained.

The transport model used in this study is particularly complex and efficient due to the fact that it consists in the coupling of an Eulerian and a Lagrangian model, continuously in time. Eulerian models are better suited for global scales and long simulation times, whereas Lagrangian models are better suited for small scales and short simulation times. The GELCA model combines both types of model to obtain simultaneously the advantages of both of them: global coverage and high spatial resolution near the observation stations. The schematic diagram of the GELCA inversion modelling framework is shown in Fig. 4.8.

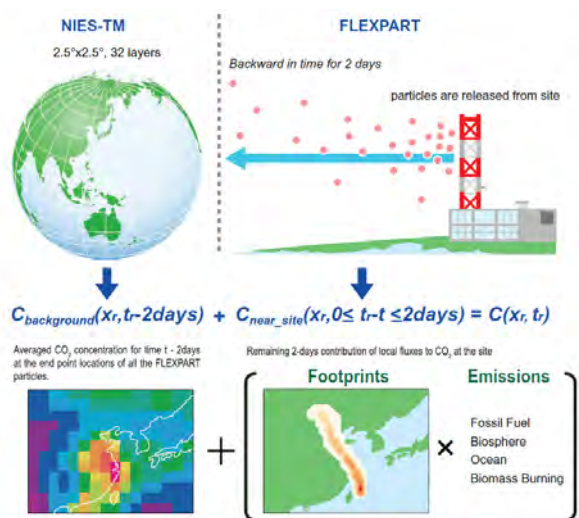

Figure 4.8. Schematic diagram of the GELCA inversion modelling framework.

This study conducted sensitivity tests to examine the impact of the site selections and the prior uncertainty settings of observation on the inversion results. For these sensitivity tests, five different site/data selections from the ObsPack product were used. In all cases, the time series of the global net CO₂ flux to the atmosphere stayed close to values calculated from the growth rate of the observed global mean atmospheric CO₂ mixing ratio. At regional scales, estimated seasonal CO₂ fluxes were altered, depending on the CO₂ data selected for assimilation.

For most observation sites, the model–data mismatch was reasonably small. Regarding regional flux estimates, tropical Asia was one of the regions that showed a significant impact from the observation network settings. Shirai et al. (2017) found that the surface fluxes in tropical Asia were the most sensitive to the use of aircraft measurements over the Pacific due to the very sparse available surface observations in tropical Asia and the deep convection presents very frequently in this region. The seasonal cycle agreed better with the results of bottom-up studies when the aircraft measurements were assimilated.

These results confirm the importance of these aircraft observations, especially for constraining surface fluxes in the tropics.

4.5.2 Global methane emission estimates for 2000–2012 from CarbonTracker Europe-CH₄ v1.0

This study presents the evaluation of the model CarbonTracker Europe-CH₄ and the results of global methane flux inversions performed with that model. As explained in the previous section 4.5.1, using a transport model and atmospheric measurements of CO₂ concentration in many stations, the surface sources and sinks of this important greenhouse gas can be better constrained performing an “Inversion” technique.

In Tsuruta et al. (2017), a similar procedure is applied to constrain surface fluxes of CH₄: 1) the a priori CH₄ surface fluxes are used in a forward run of the transport model; 2) the simulated CH₄ concentrations obtained for each time step are compared with the measured concentrations (Fig. 4.9); 3) from these differences in CH₄ concentration, the improvements that need to be applied to the CH₄ surface fluxes to minimize those differences are deduced; and therefore, a more accurate a posteriori value for the CH₄ surface fluxes is obtained.

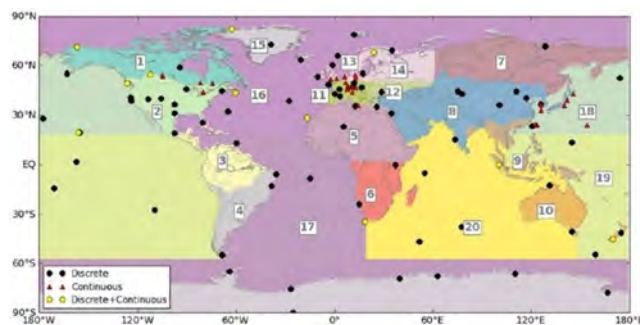

Figure 4.9. Decomposition of the Earth surface in regions used by the model and locations of sites with observations assimilated in the inversions (“Discrete”: weekly flask samples analysed in a central lab; “Continuous”: instrument measuring continuously at the station). Reprinted from Tsuruta et al. (2017).

Three different configurations were used to assess the sensitivity of the CH₄ flux estimates to (a) the number of unknown flux scaling factors to be optimized which in turn depends on the choice of underlying land-ecosystem map (Fig. 4.10), and (b) on the parametrization of vertical mixing in the atmospheric transport model TM5.

The posterior emission estimates were evaluated by comparing simulations to surface in-situ observation sites, to profile observations made by aircraft, and to dry air total column-averaged mole fraction observations. The posterior estimated Global methane emissions for 2000–2012 are $516 \pm 51 \text{ Tg CH}_4 \text{ yr}^{-1}$, and emission estimates during 2007–2012 are $18 \text{ Tg CH}_4 \text{ yr}^{-1}$, greater than those from 2001–2006, mainly driven by an increase in emissions from the south

America temperate region, the Asia temperate region and Asia tropics.

The posterior estimates for the northern latitude regions show significant sensitivity to the choice of convection scheme in TM5. The evaluation with non-assimilated observations showed that posterior mole fractions were better matched with the observations when a convection scheme was used.

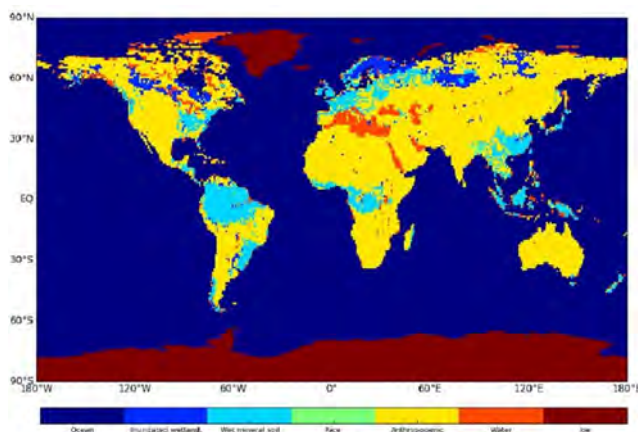

Figure 4.10. Land-ecosystem map used in the regional definition in the optimisation. Reprinted from Tsuruta et al. (2017).

4.5.3 Adaptive selection of diurnal minimum variation: a statistical strategy to obtain representative atmospheric CO₂ data and its application to European elevated mountain stations

Yuan et al. (2018) present a new statistical data selection method named “Adaptive Diurnal minimum Variation Selection” (ADVS) for determining representative baseline levels of atmospheric trace gases even at remote measurement sites. Critical data selection is based on CO₂ diurnal patterns typically occurring at elevated mountain stations.

In the case of the Izaña Observatory, we can observe how the CO₂ records show a daily variation with minimum values (and associated relatively high standard deviations) somewhat after noon, and higher and very stable values (minimum standard deviation). This diurnal cycle varies throughout the year, as does the valley-mountain breeze regime modulated by solar radiation and corresponding slope warming (Fig. 4.11).

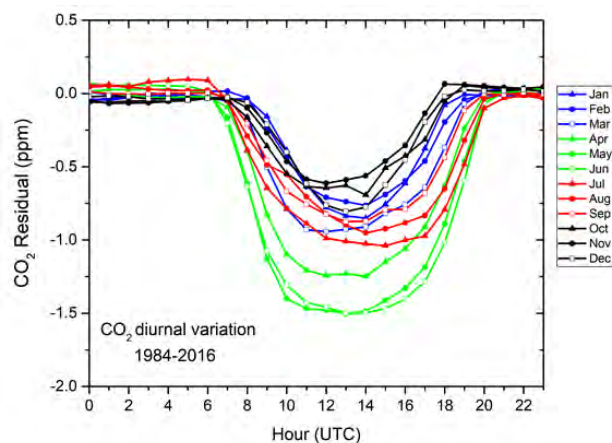

Figure 4.11. Mean diurnal variation of CO₂ residuals for each month of the year in the period 1984-2016. The residuals have been calculated daily as the difference of CO₂ for every hour compared with the night-time (20:00-08:00 UTC) background level.

This work develops in depth, ideas already used at the Izaña Observatory in the early 1990s in order to discriminate representative data of the free troposphere, from those impacted by air from lower levels, modulated by the breeze regime, and affected during the daylight period by CO₂ absorption processes by the pine forest that surrounds the island located, to a large extent, within the marine mixed layer (e.g. Cuevas, 1995) and therefore not representative of the free troposphere.

Its capability and applicability were studied on atmospheric CO₂ observation records at six Global Atmosphere Watch stations in Europe: Zugspitze-Schneefernerhaus (Germany); Sonnblick (Austria); Jungfrauoch (Switzerland); Izaña (Spain); Schauinsland (Germany) and Hohenpeissenberg (Germany). Three other frequently applied statistical data selection methods were included for comparison. The results showed that the ADVS method resulted in a lower fraction of data selected as a baseline with lower maxima during winter and higher minima during summer in the selected data. The measured time series were analyzed for long-term trends and seasonality by a seasonal-trend decomposition technique.

In contrast to unselected data, mean annual growth rates of all selected datasets were not significantly different among the sites. However, clear differences were found in the annual amplitudes as well as the seasonal time structure. Based on a pair wise analysis of correlations between stations on the seasonal-trend decomposed components by statistical data selection, the authors conclude that the baseline identified by the ADVS method is a better representation of lower free tropospheric (LFT) conditions than baselines identified by the other methods.

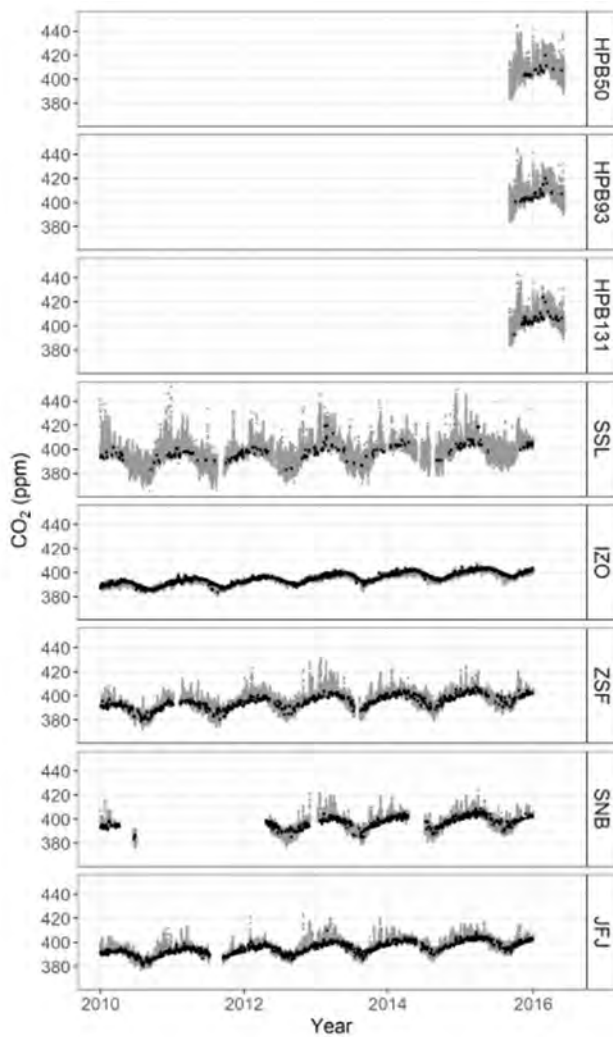

Figure 4.12. Time series plots of validated CO₂ datasets (gray), and selected datasets by ADVS (black) at six GAW stations. Reprinted from Yuan et al. (2018). The comparison indicates that IZO shows the least noisy and most stable CO₂ record of all stations.

According to this study, IZO can be considered as better representing the lower free tropospheric conditions out of the six stations. The obtained trend agrees well with the mean annual global CO₂ growth rates (2.31 ppm) during the same time period (2010–2015) based on data from <https://www.esrl.noaa.gov/gmd/ccgg/trends/global.html>.

4.6 References

CarbonTracker Team; (2018): Simulated observations of atmospheric carbon dioxide from CarbonTracker release CT2017; NOAA Earth System Research Laboratory, Global Monitoring Division. https://www.esrl.noaa.gov/gmd/ccgg/carbontracker/CT2017_doc.php.

Chevallier, F., P. Ciais, T. J. Conway, T. Aalto, B. E. Anderson, P. Bousquet, E. G. Brunke, L. Ciattaglia, Y. Esaki, M. Fröhlich, A. Gomez, A. J. Gomez-Pelaez, L. Haszpra, P. B. Krummel, R. L. Langenfelds, M. Leuenberger, T. Machida, F. Maignan, H. Matsueda, J. A. Morgui, H. Mukai, T. Nakazawa, P. Peylin, M. Ramonet, L. Rivier, Y. Sawa, M. Schmidt, L. P. Steele, S. A. Vay, A. T. Vermeulen, S. Wofsy, D. Worthy, CO₂ surface

fluxes at grid point scale estimated from a global 21 year reanalysis of atmospheric measurements, *J. Geophys. Res.*, 115, D21307, doi:10.1029/2010JD013887, 2010.

Cooperative Global Atmospheric Data Integration Project; (2019): Multi-laboratory compilation of atmospheric carbon dioxide data for the period 1957-2018; obspack_co2_1_GLOBALVIEWplus_v5.0_2019-08-12; NOAA Earth System Research Laboratory, Global Monitoring Division. <https://search.datacite.org/works/10.25925/20190812>

Cuevas-Agulló, E.: Estudio del Comportamiento del Ozono Troposférico en el Observatorio de Izaña (Tenerife) y su Relación con la Dinámica Atmosférica, Universidad Complutense de Madrid, ISBN: 978-84-669-0399-8, 251pp, available at <http://eprints.ucm.es/1964/1/T20635.pdf>, February 1995.

Gomez-Pelaez, A.J., Ramos, R., Perez-delaPuerta, J., "Methane and carbon dioxide continuous measurements at Izaña GAW station (Spain)" in GAW Report (No. 168) of the "13th WMO/IAEA Meeting of Experts on Carbon Dioxide Concentration and Related Tracers Measurement Techniques (Boulder, Colorado, USA, 19-22 September 2005)", edited by J.B. Miller, World Meteorological Organization (TD No. 1359), 180-184, 2006.

Gomez-Pelaez, A.J., Ramos, R., "Installation of a new gas chromatograph at Izaña GAW station (Spain) to measure CH₄, N₂O, and SF₆" in GAW Report (No. 186) of the "14th WMO/IAEA meeting of experts on Carbon dioxide, other greenhouse gases, and related tracers measurement techniques (Helsinki, Finland, 10-13 September 2007)", edited by Tuomas Laurila, World Meteorological Organization (TD No. 1487), 55-59, 2009.

Gomez-Pelaez, A.J., Ramos, R., "Improvements in the Carbon Dioxide and Methane Continuous Measurement Programs at Izaña Global GAW Station (Spain) during 2007-2009", in GAW report (No. 194) of the "15th WMO/IAEA Meeting of Experts on Carbon Dioxide, Other Greenhouse Gases, and Related Tracer Measurement Techniques (Jena, Germany; September 7-10, 2009)", edited by Willi A. Brand, World Meteorological Organization (TD No. 1553), 133-138, 2011.

Gomez-Pelaez, A.J., R. Ramos, V. Gomez-Trueba, R. Campo-Hernandez, E. Dlugokencky, T. Conway "New improvements in the Izaña (Tenerife, Spain) global GAW station in-situ greenhouse gases measurement program" in GAW report (No. 206) of the "16th WMO/IAEA Meeting on Carbon Dioxide, Other Greenhouse Gases, and Related Measurement Techniques (GGMT-2011) (Wellington, New Zealand, 25-28 October 2011)", edited by Gordon Brailsford, World Meteorological Organization, 76-81, 2012.

Gomez-Pelaez, A. J., Ramos, R., Gomez-Trueba, V., Novelli, P. C., and Campo-Hernandez, R.: A statistical approach to quantify uncertainty in carbon monoxide measurements at the Izaña global GAW station: 2008–2011, *Atmos. Meas. Tech.*, 6, 787-799, doi:10.5194/amt-6-787-2013, 2013.

Gomez-Pelaez, A.J., R. Ramos, V. Gomez-Trueba, R. Campo-Hernandez, E. Reyes-Sanchez: "Izaña Global GAW station greenhouse-gas measurement programme. Novelty and developments during October 2011-May 2013" in GAW report (No. 213) of the "17th WMO/IAEA Meeting on Carbon Dioxide, Other Greenhouse Gases, and Related Measurement Techniques (Beijing, China, June 10-14, 2013)", edited by P. Tans and C. Zellweger, World Meteorological Organization, 77-82, 2014.

Gomez-Pelaez, A.J., R. Ramos, V. Gomez-Trueba, R. Campo-Hernandez, E. Reyes-Sanchez: "GGMT-2015 Izaña station

- update: instrumental and processing software developments, scale updates, aircraft campaign, and plumbing design for CRDS" in GAW report (No. 229) of the "18th WMO/IAEA Meeting on Carbon Dioxide, Other Greenhouse Gases, and Related Measurement Techniques (GGMT) (La Jolla, CA, USA, 13-17 September, 2015)", edited by P. Tans and C. Zellweger, World Meteorological Organization, 125-131, 2016.
- Gomez-Pelaez, A. J., Ramos, R., Cuevas, E., Gomez-Trueba, V., and Reyes, E.: Atmospheric CO₂, CH₄, and CO with CRDS technique at the Izaña Global GAW station: instrumental tests, developments and first measurement results, *Atmos. Meas. Tech. Discuss.*, <https://doi.org/10.5194/amt-2017-375>, in review, 2017.
- Gomez-Pelaez, A. J., Ramos, R., Cuevas, E., Gomez-Trueba, V., and Reyes, E.: Atmospheric CO₂, CH₄, and CO with the CRDS technique at the Izaña Global GAW station: instrumental tests, developments, and first measurement results, *Atmos. Meas. Tech.*, 12, 2043–2066, <https://doi.org/10.5194/amt-12-2043-2019>, 2019.
- Scheel, H.E. (2009), System and Performance Audit for Nitrous Oxide at the Global GAW Station Izaña, Tenerife, Spain, November 2008, WCC-N2O Report 2008/11, http://www.aemet.izana.org/publications/Rep_WCCN2O_2008_IZOAudit.pdf
- Shirai, T., M. Ishizawa, R. Zhuravlev, A. Ganshin, D. Belikov, M. Saito, T. Oda, V. Valsala, A.J. Gomez-Pelaez, R. Langenfelds, and S. Maksyutov; A decadal inversion of CO₂ using the Global Eulerian–Lagrangian Coupled Atmospheric model (GELCA): sensitivity to the ground-based observation network, *Tellus B: Chemical and Physical Meteorology*, Vol. 69 , Iss. 1, 2017.
- Thoning, K.W., P.P. Tans, and W.D. Komhyr; Atmospheric carbon dioxide at Mauna Loa Observatory, 2. Analysis of the NOAA/GMCC data, 1974 1985., *J. Geophys. Res.* ,94, 8549 8565, 1989.
- Tsuruta, A., Aalto, T., Backman, L., Hakkarainen, J., van der Laan-Luijkx, I. T., Krol, M. C., Spahni, R., Houweling, S., Laine, M., Dlugokencky, E., Gomez-Pelaez, A. J., van der Schoot, M., Langenfelds, R., Ellul, R., Arduini, J., Apadula, F., Gerbig, C., Feist, D. G., Kivi, R., Yoshida, Y., and Peters, W.: Global methane emission estimates for 2000–2012 from CarbonTracker Europe-CH4 v1.0, *Geosci. Model Dev.*, 10, 1261-1289, [doi:10.5194/gmd-10-1261-2017](https://doi.org/10.5194/gmd-10-1261-2017), 2017.
- Yuan, Y., Ries, L., Petermeier, H., Steinbacher, M., Gómez-Peláez, A. J., Leuenberger, M. C., Schumacher, M., Trickl, T., Couret, C., Meinhardt, F., and Menzel, A.: Adaptive selection of diurnal minimum variation: a statistical strategy to obtain representative atmospheric CO₂ data and its application to European elevated mountain stations, *Atmos. Meas. Tech.*, 11, 1501-1514, <https://doi.org/10.5194/amt-11-1501-2018>, 2018.
- Zellweger, Christoph, et al. (2009), System and Performance Audit of Surface Ozone, Carbon Monoxide, Methane and Nitrous Oxide at the Global GAW Station Izaña, Spain, March 2009, WCC-Empa Report 09/1, http://gaw.empa.ch/audits/IZO_2009.pdf
- Zellweger, C., M. Steinbacher, B. Buchmann, R. Steinbrecher (2015), System and Performance Audit of Surface Ozone, Methane, Carbon Dioxide, Nitrous Oxide and Carbon Monoxide at the Global GAW Station Izaña, September 2013. WCC-Empa Report 13/2, http://gaw.empa.ch/audits/IZO_2013.pdf
- World Data Centre for Greenhouse Gases (WDCGG), WMO WDCGG Data Summary, GAW Data (Volume IV-Greenhouse Gases and Other Atmospheric Gases), WDCGG No. 42, Japan Meteorological Agency in Co-operation with World Meteorological Organization, 2018.

4.7 Staff

- Dr Emilio Cuevas (AEMET; new Coordinator of programme)
- Pedro Pablo Rivas Soriano (AEMET; Software and data processing)
- Ramón Ramos (AEMET; Head of Infrastructure and instrumentation)
- Enrique Reyes (AEMET; Software and data processing)
- Vanessa Gómez-Trueba (Air Liquide)
- Dr Ángel Gómez-Peláez (AEMET; former programme Head) left IARC in October 2017

5 Reactive Gases and Ozonesondes

5.1 Main Scientific Goals

The main scientific objectives of this programme are:

- Long-term high quality observations of reactive gases (CO, NO_x, SO₂) in both the free troposphere (FT) and the Marine Boundary Layer (MBL) to support other measurement programmes at IARC.
- Long-term high quality observations and analysis of tropospheric O₃ in the FT and in the MBL.
- Air quality studies in urban and background conditions.
- Analysis of long-range transport of pollution (e.g. transport of anthropogenic and wildfire pollution from North America).
- Study of the impact of dust and water vapour on tropospheric O₃.
- Analysis and characterization of the Upper Troposphere-Lower Stratosphere (UTLS).
- Analysis of Stratosphere-Troposphere Exchange processes.

5.2 Measurement Programme

The measurement programme of reactive gases (O₃, CO, NO_x and SO₂) (Figure 5.1) includes long-term observations at IZO, SCO and BTO (see Tables 3.2, 3.4 and 3.5) and ozonesonde vertical profiles at Tenerife (now at BTO). In addition, IARC (through AEMET and INTA) has a long-term collaboration with the Argentinian Meteorological Service (SMN) and in the framework of this collaboration, ozone vertical profiles are measured at Ushuaia GAW Global station (Argentina). Surface O₃ measurements started in 1987, CO in 2004, and SO₂ and NO_x measurements were implemented in 2006 at IZO. At SCO, surface O₃ measurements started in 2001, and CO, SO₂ and NO_x programmes were also implemented in 2006.



Figure 5.1. Reactive gases analysers. Left panel: Izaña Atmospheric Observatory. Right panel: Santa Cruz Observatory.

Details of the reactive gases and ozonesondes measurement programme are described in González (2012) and Cuevas et al. (2013). The surface O₃ programme is considered a particularly important programme at IZO due to both free troposphere conditions of the site and the quality and length of the data series. The almost uninterrupted 32-year time series of surface O₃ at IZO is shown in Fig. 5.2. Surface O₃ data at IZO have been calibrated against references that are traceable to the US National Institute for Standards and Technology (NIST) reference O₃ photometer (Gaithersburg, Maryland, USA). The surface O₃ programme at IZO has been audited by the [World Calibration Centre for Surface Ozone, Carbon Monoxide, Methane and Carbon Dioxide \(WCC-Ozone-CO-CH₄-CO₂-EMPA\)](#) in 1996, 1998, 2000, 2004, 2009, 2013 and 2019. EMPA's audit reports are available [here](#).

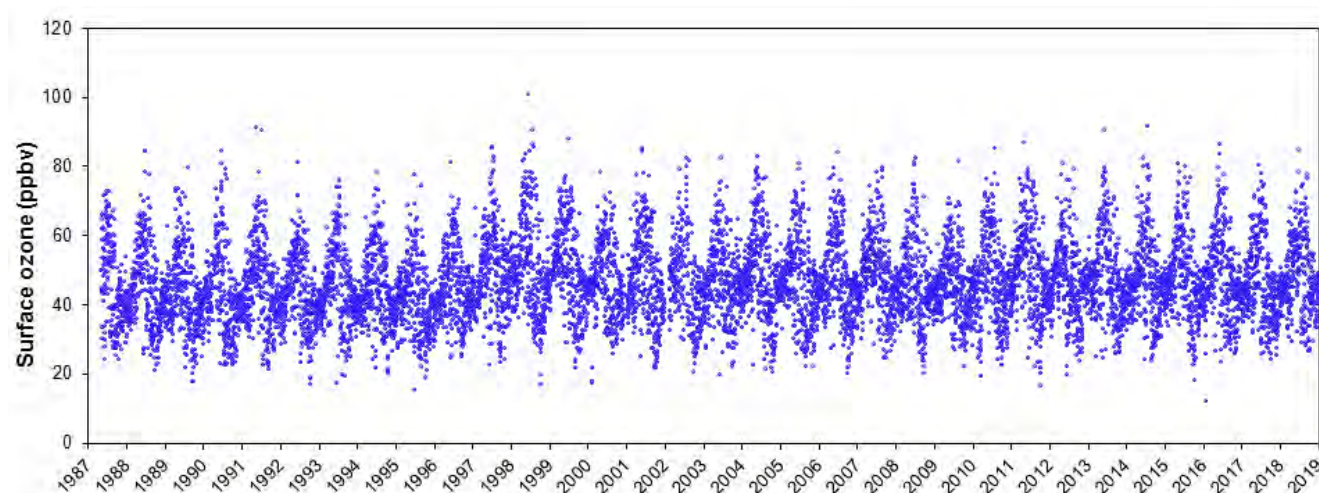

Figure 5.2. Long-term daily (night period) surface O₃ at IZO (1987-2018).

In addition, every 3 months all surface O₃ analysers are checked with the station calibrator TEI 49C-PS #56085-306, which was calibrated against the WCC-EMPA ozone reference (SRP#15) to check if there is any drift in the instruments. The error must be less than 1% to consider that the instrument has not changed and therefore maintains the WCC-EMPA calibration.

Following the EMPA 2013 audit recommendations, a new surface ozone analyzer TEI 49i #1153030026 was purchased and started operation at IZO on 7 December 2015. Throughout 2016-2018 the instrument was inter-compared with the primary and secondary O₃ analysers, and regularly (every 3 months) calibrated against the station calibrator. This instrument will soon be designated the new primary analyser and the current primary analyser will be installed during 2019 at the Teide Peak Observatory (TPO). In the second half of 2018, the three surface O₃ analysers were calibrated using the TEI 49-PS in order to prepare for the WCC-EMPA audit which took place in May 2019. Meticulous analyzes were also made to define which of these analysers would be the primary and secondary analysers of IZO, and which of them would be installed at the TPO station.

NO_x and SO₂ instruments at IZO usually operate below the detection limit (50 pptv) during the night-time period when we can ensure background conditions. However, these measurements are quite useful for studies of local or regional pollution during daytime, when concentrations are modulated by valley-mountain breeze, and help to understand the impact of regional pollution. A detailed description of these measurement programmes, including quality control and quality assurance protocols is provided by González (2012).

In order to significantly improve the NO-NO₂-NO_x measurement programme, in 2018 we requested a new NO-NO₂-NO_x analyzer from the Spanish National R&D call for scientific infrastructure funding. The infrastructure project was approved at the end of 2018, and the new equipment is expected to be installed by the end of 2019. Given the background atmospheric conditions of IZO, a NO-NO₂-NO_x analyzer with a greater sensitivity than the chemical-luminescent detector (CLD) for the determination of NO and NO₂, with detection limits of the order of 10 ppt for NO and 20 ppt for NO₂ is required. The new instrument selected is the ECO PHYSICS CraNO_x II. This instrument also has a double channel to perform simultaneous measurements of NO and NO_x, and O₃ to correct the NO_x measurements of O interference during the photolysis reaction.

The SO₂ analyzer in IZO began to show signs of instability on 11 January 2016, finding out later that its optical part was damaged as the reflecting mirrors were burnt. In January 2018, the damaged mirrors were replaced and after several adjustments, the equipment became operational again.

CO is measured with high accuracy at IZO by the Greenhouse Gases and Carbon Cycle Programme, following the GAW recommendations (see Section 4 for more details). CO measurements are also performed at SCO with the non-dispersive IR absorption technique and utilized for air quality research.

5.2.1 Ozonesonde vertical profiles

The ozone vertical profile measurements were initiated in November 1992 using the Electrochemical concentration cell (ECC) ozonesonde technique. The equipment and launching stations used in this programme are indicated in Table 5.1. Launches are performed once a week (Wednesday). The frequency of ozone soundings in this station is significantly increased during intensive campaigns.

At the start of the programme, the ozonesondes were launched from Santa Cruz Station and since 2011 they have been launched from BTO. This programme provides ozone profiles from the ground to the burst level (generally between 30 and 35 km) with a resolution of about 10 metres. A constant mixing ratio above burst level is assumed for the determination of the residual ozone if an altitude equivalent to 17 hPa has been reached.



Figure 5.3. a) Marcos Damas preparing the ozonesonde for launch and b) launch of ozonesonde at BTO.

Ozonesondes are checked before launching with a Ground Test with Ozonizer/Test Unit TSC-1 (see Section 3.2.2 and Fig. 5.4). The ECC-ozone sensor used is an electrochemical cell consisting of two half cells, made of Teflon, which serve as cathode and anode chambers, respectively. Both half cells contain platinum mesh electrodes. They are immersed in a KI-solution, always with the same sensing solution type (SST1.0: 1.0% KI & full pH-buffer) since the beginning of the Ozonesonde Programme (Nov 1992). The two chambers are linked together by an ion bridge in order

to provide an ion pathway and to prevent mixing of the cathode- and anode electrolytes.

The main features of the ozonesonde system currently in use (see Table 5.1) are the following:

- Sensor: ECC-6A
- Balloon: TOTEX TA 1200
- Radiosonde: RS-41
- Receiver: DigiCora MW41
- Wind system: GPS



Figure 5.4. Preparation of an ozone electrochemical cell at the Ozonesonde Laboratory, BTO.



Figure 5.5. a) Preparing the ozonesonde for launch; b) BTO ozonesonde launching station.

Table 5.1. Ozonesonde Programme equipment used in different time periods and launching stations since November 1992.

Instrument manufacturer and model	Frequency	Period/Launching station
<p>OZONESONDES: Nov 1992 – Sep 1997: Science Pump Corp. Model ECC-5A Sep 1997 – present: Science Pump Corp. Model ECC-6A</p> <p>GROUND EQUIPMENT: Nov 1992 – Oct 2010: VAISALA DigiCora MW11 Rawinsonde Oct 2010 – Feb 2018: VAISALA DigiCora MW31 Mar 2018 – present: VAISALA DigiCora MW41</p> <p>RADIOSONDES: Nov 1992 – Oct 1997: VAISALA RS80-15NE (Omega wind data) Oct 1997 – Sep 2006: VAISALA RS80-15GE (GPS Wind data) Sep 2006 - Dec 2018: VAISALA RS92-SGP (GPS Wind data) Dec 2018 - present: VAISALA RS41-SGP (GPS Wind data)</p>	1/week (Wed)	<p>Nov 1992 – Oct 2010: From Santa Cruz Station (28.46°N-16.26°W; 36 m a.s.l.)</p> <p>Oct 2010 – Feb 2011: From Santa Cruz/ BTO (In alternate launches)</p> <p>Feb 2011 – present: From BTO Station (28.41°N-16.53°W; 114 m a.s.l.)</p>

5.3 Summary of remarkable results during the period 2017-2018

5.3.1 Software for the evaluation of reactive gases data (O₃, NO_x, SO₂, CO)

The software for reactive gases data evaluation was developed during 2015 and 2016, and improved in 2017-2018. This software makes it possible to carry out the evaluation and processing of the data of the reactive gases programme (surface O₃, NO_x, SO₂ and CO). The software works in a web environment that facilitates consultations with the database and data processing.

The raw data are acquired by a CR1000 Campbell datalogger, which interrogates each instrument every minute. The data are automatically stored in a database, zeros, span and calibration coefficients of the analysers are also recorded. The software uses all this information to process automatically the data and it allows us to choose the desired component to evaluate and visualize its record along with that of another component and/or together with the meteorological information (temperature, relative humidity, pressure and wind).

5.3.2 World Data Center for Reactive Gases (WDCRG)

The World Data Center for Reactive Gases (WDCRG) is the data repository and archive for reactive gases of the GAW Programme. The WDCRG was established on 1 January 2016 and takes over the responsibility of RG data archiving from the Japan Meteorological Agency, which will continue to host the World Data Centre on Greenhouse Gases (WDCGG). The reactive gases hosted at WDCRG are: SO₂, oxidized nitrogen species, surface O₃ and VOCs. We have developed the necessary software to edit surface O₃ data in the new format required by the WDCRG. Hourly surface O₃ data from 2013 to 2017 have been submitted to WDCRG (<http://ebas.nilu.no>) and O₃ data from 1987 to 2013 are still available in the WDCGG until the migration is completed to the new database.

5.3.3 The Ozone Sonde Data Homogenization project and Network for the Detection of Atmospheric Composition Change (NDACC)

Although there have not been any changes in ECC O₃ manufacturer or changes in sensing solution type (Vaisala ECC-SPC5A/6A-1.0% KI & full pH-buffer) since the beginning of the Ozone Sonde Programme (November 1992), some non-uniformity in data processing could have occurred through the programme time period. This can lead to some inhomogeneities in time series and records and thus may influence the trends derived from such records dramatically. The Assessment of Standard Operating Procedures for Ozone sondes (ASOPOS, Smit et al., 2013) demonstrated that, after standardization and

homogenization, improvement of precision and accuracy by about a factor of two might be yielded.

For these reasons, a WMO “Ozone Sonde Data Quality Assessment (O3S-DQA)” activity was initiated with the following two major objectives:

- 1) Homogenization of selected ozonesonde data sets to be used for the ozone assessment with the goal to reduce uncertainty from 10-20% down to 5-10% (focus on transfer function).
- 2) Documentation of the homogenization process and the quality of ozonesonde measurements generally to allow the recent records to be linked to older records.

In the context of the WMO/GAW O3S-DQA activity, some O₃-sounding stations, one of them the IZO station, were selected to be involved in the homogenization process, following the “Guide Lines for Homogenization of Ozone Sonde Data” (Smit et. al, 2012) prepared by the O3S-DQA panel members.

The reprocessing carried out in our station is being supervised by Dr Herman Smit (Jülich Forschung Zentrum, Germany), leader of the O3S-DQA panel. This work was initiated in 2016 and we are working currently on two essential aspects: the estimation of expected uncertainties and the detailed documentation of the reprocessing of the long term ozonesonde records.

In 2004, the Izaña Atmospheric Observatory joined NDACC and began routinely archiving the ozonesonde data into the NDACC database; in addition, all the ozonesonde records since 1995 were uploaded to the NDACC at this time. Ozonesondes archived must meet the quality criteria of the NDACC database. Currently 94% of the ozone soundings performed in the period 1995-2018 are in the NDACC network (Figure 5.6). Ozonesondes from the early period (November 1992-1994) need to be reprocessed and reanalysed carefully. Another aim of the homogenization is to recover these ozone soundings for the NDACC database. The ozonesonde data are also available at the World Ozone and Ultraviolet Data Center (WOUDC).

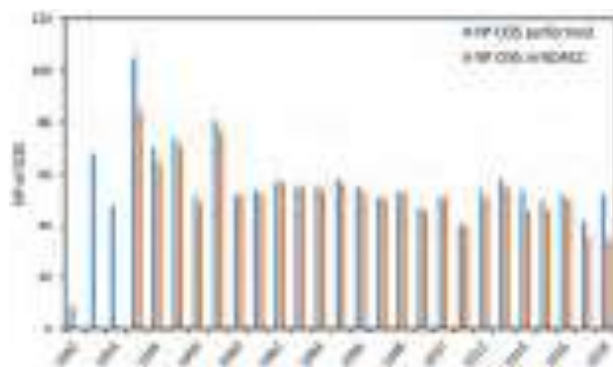

Figure 5.6. Number of ozone soundings (O3S) launched since the beginning of the programme and the number of ozonesondes recorded in the NDACC network meeting the quality assurance criteria (1992-2018).

5.3.4 The TOAR project

The Tropospheric Ozone Assessment Report (TOAR): Global metrics for climate change, human health and crop/ecosystem research, is an Activity of the International Global Atmospheric Chemistry Project (IGAC), approved by the IGAC Scientific Steering Committee on 13 March 2014. The mission of TOAR is to provide the research community with an up-to-date scientific assessment of tropospheric ozone's global distribution and trends from the surface to the tropopause.



Tropospheric ozone is a greenhouse gas and pollutant detrimental to human health and crop and ecosystem productivity. Since 1990 a large portion of the anthropogenic emissions that react in the atmosphere to produce ozone have shifted from North America and Europe to Asia. This rapid shift, coupled with limited ozone monitoring in developing nations, has left scientists unable to answer the most basic questions: Which regions of the world have the greatest human and plant exposure to ozone pollution? Is ozone continuing to decline in nations with strong emission controls? To what extent is ozone increasing in the developing world? How can the atmospheric sciences community facilitate access to the ozone metrics necessary for quantifying ozone's impact on human health and crop/ecosystem productivity?

TOAR is designed to answer these questions through the development of an assessment report based on expert opinion and analysis, and the generation of a range of ozone metrics at hundreds of sites around the world.

The main two goals are: 1) Produce the first tropospheric ozone assessment report based on the peer-reviewed literature and new analyses; and 2) Generate easily accessible, documented data on ozone exposure and dose metrics at thousands of measurement sites around the world (urban and non-urban), freely accessible for research on the global-scale impact of ozone on climate, human health and crop/ecosystem productivity.

5.3.5 TOAR: Database and metrics data of global surface ozone observations

In support of the first Tropospheric Ozone Assessment Report a relational database of global surface ozone observations has been developed and populated with hourly measurement data and enhanced metadata (Schultz et al., 2017). A comprehensive suite of ozone data products including standard statistics, health and vegetation impact metrics, and trend information, are made available through

a common data portal and a web interface. These data form the basis of the TOAR analyses focusing on human health, vegetation, and climate relevant ozone issues. Cooperation among many data centers and individual researchers worldwide made it possible to build the world's largest collection of in-situ hourly surface ozone data covering the period from 1970 to 2015. By combining the data from almost 10,000 measurement sites around the world with global metadata information, new analyses of surface ozone have become possible such as the first globally consistent characterisations of measurement sites as either urban or rural/remote.

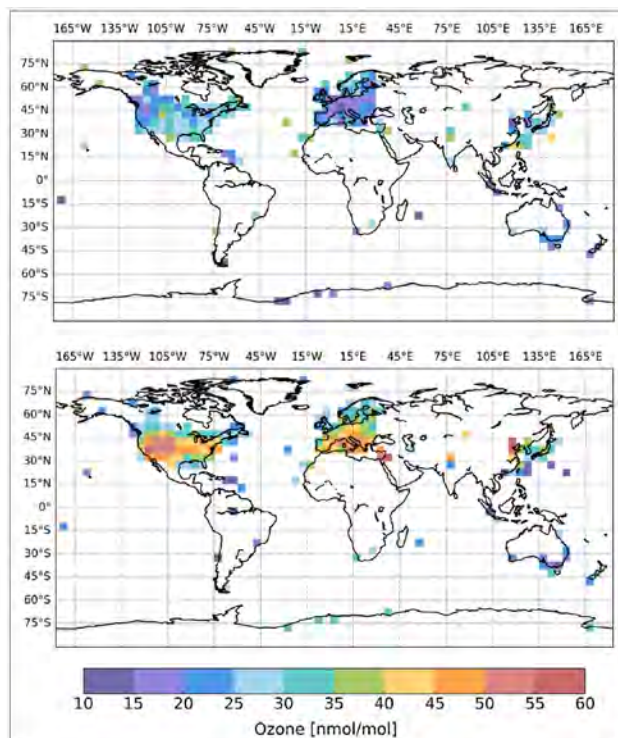

Figure 5.7. Monthly daytime (8–20 h local time) average ozone mole fractions during 2010–2014 gridded onto a $5^\circ \times 5$ longitude-latitude grid. Top: January, bottom: July. All stations at altitudes below 2000 m and with at least 3 years of data during the interval were included. (Reprinted from Schultz et al., 2017).

Exploitation of these global metadata allows for new insights into the global distribution (e.g. Fig. 5.7), and seasonal and long-term changes of tropospheric ozone and they enable TOAR to perform the first, globally consistent analysis of present-day ozone concentrations and recent ozone changes with relevance to health, agriculture, and climate. Considerable effort was made to harmonize and synthesize data formats and metadata information from various networks and individual data submissions. Extensive quality control was applied to identify questionable and erroneous data, including changes in apparent instrument offsets or calibrations. Such data were excluded from TOAR data products. Limitations of a posteriori data quality assurance are discussed.

As a result of the work contributing to the Tropospheric Ozone Assessment Report and presented in Schultz et al. (2017), global coverage of surface ozone data for scientific analysis has been significantly extended. Yet, large gaps remain in the surface observation network both in terms of regions without monitoring, and in terms of regions that have monitoring programs but no public access to the data archive. Therefore future improvements to the database will require not only improved data harmonization, but also expanded data sharing and increased monitoring in data-sparse regions.

5.3.6 TOAR: Present-day distribution and trends of tropospheric ozone relevant to climate and global atmospheric chemistry model evaluation

This study and corresponding paper (Gaudel et al., 2018), to which IARC has contributed, is a component of the TOAR report focusing on the present-day distribution and trends of tropospheric ozone relevant to climate and global atmospheric chemistry model evaluation. Utilizing the TOAR surface ozone database, the authors present the global distribution and trends of daytime average ozone at 2702 non-urban monitoring sites, highlighting the regions and seasons of the world with the greatest ozone levels. Similarly, ozonesonde and commercial aircraft observations reveal ozone's distribution throughout the depth of the free troposphere. Long-term surface observations are limited in their global spatial coverage, but data from remote locations indicate that ozone in the 21st century is greater than during the 1970s and 1980s (Fig. 5.8). While some remote sites and many sites in the heavily polluted regions of East Asia show ozone increases since 2000, many others show decreases and there is no clear global pattern for surface ozone changes since 2000.

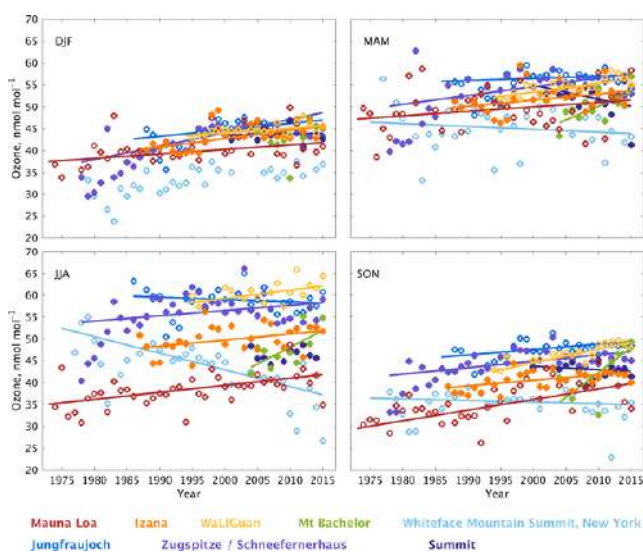

Figure 5.8. Nighttime ozone trends at eight Northern Hemisphere mountaintop sites by season. Reprinted from Gaudel et al. (2018).

Two new satellite products provide detailed views of ozone in the lower troposphere across East Asia and Europe, revealing the full spatial extent of the spring and summer ozone enhancements across eastern China that cannot be assessed from limited surface observations.

Sufficient data are now available (ozonesondes, satellite, aircraft) across the tropics from South America eastwards to the western Pacific Ocean, to indicate a likely tropospheric column ozone increase since the 1990s. The 2014–2016 mean tropospheric ozone burden (TOB) between 60°N–60°S from five satellite products is $300 \text{ Tg} \pm 4\%$. While this agreement is excellent, the products differ in their quantification of TOB trends and further work is required to reconcile the differences. Satellites can now estimate ozone's global long-wave radiative effect, but evaluation is difficult due to limited in situ observations where the radiative effect is greatest.

5.3.7 Validation of satellite ozone profiles

The Ozone Monitoring Instrument (OMI) Ozone Profile (PROFOZ) product from October 2004 through December 2014 retrieved by the Smithsonian Astrophysical Observatory (SAO) algorithm was validated against ozonesonde observations (Huang et al., 2017). The distribution of ozonesonde stations utilized in this study is shown in Fig. 5.9. The effects of OMI row anomaly (RA) on the retrieval was also evaluated by dividing the dataset into before and after the occurrence of serious OMI RA, i.e., pre-RA (2004–2008) and post-RA (2009–2014).

The retrieval shows good agreement with ozonesondes in the tropics and midlatitudes and for pressure $< \sim 50 \text{ hPa}$ in the high latitudes. It demonstrates clear improvement over the a priori down to the lower troposphere in the tropics and down to an average of ~ 550 (300) hPa at middle (high) latitudes. In the tropics and midlatitudes, the profile mean biases (MBs) are less than 6%, and the standard deviations (SDs) range from 5 to 10% for pressure $< \sim 50 \text{ hPa}$ to less than 18% (27%) in the tropics (midlatitudes) for pressure $> \sim 50 \text{ hPa}$ after applying OMI averaging kernels to ozonesonde data.

The MBs of the stratospheric ozone column (SOC, the ozone column from the tropopause pressure to the ozonesonde burst pressure) are within 2% with SDs of $< 5\%$ and the MBs of the tropospheric ozone column (TOC) are within 6% with SDs of 15% (Fig. 5.9). In the high latitudes, the profile MBs are within 10% with SDs of 5–15% for pressure $< \sim 50 \text{ hPa}$ but increase to 30% with SDs as great as 40% for pressure $> \sim 50 \text{ hPa}$. The SOC MBs increase up to 3% with SDs as great as 6% and the TOC SDs increase up to 30%.

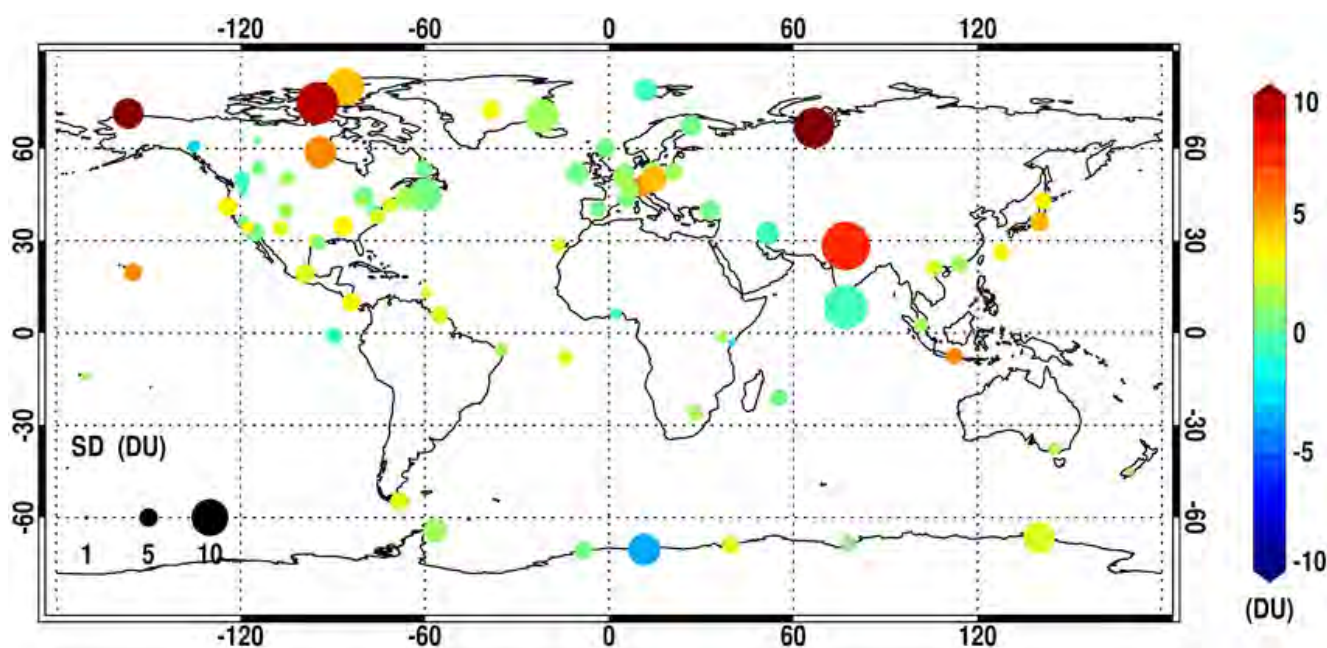

Figure 5.9. The distribution of ozonesonde stations in this study. The color represents the mean biases between OMI and ozonesonde tropospheric ozone columns (TOCs) at each station (if the number of OMI and ozonesonde pairs is more than 10), and the dot size represents the standard deviation. Reprinted from Huang et al. (2017).

The comparison generally degrades at larger solar zenith angles (SZA) due to weaker signals and additional sources of error, leading to worse performance at high latitudes and during the midlatitude winter. Agreement also degrades with increasing cloudiness for pressure $> \sim 100$ hPa and varies with cross-track position, especially with large MBs and SDs at extreme off-nadir positions. In the tropics and midlatitudes, the post-RA comparison is considerably worse with larger SDs reaching 2% in the stratosphere and 8% in the troposphere and up to 6% in TOC.

There are systematic differences that vary with latitude compared to the pre-RA comparison. The retrieval comparison demonstrates good long-term stability during the pre-RA period but exhibits a statistically significant trend of $0.14\text{--}0.7\%$ year⁻¹ for pressure $< \sim 80$ hPa, 0.7 DU year⁻¹ in SOC, and -0.33 DU year⁻¹ in TOC during the post-RA period. The spatiotemporal variation of retrieval performance suggests the need to improve OMI's radiometric calibration especially during the post-RA period to maintain the long-term stability and reduce the latitude/season/SZA and cross-track dependency of retrieval quality.

5.4 References

- Cuevas, E., González, Y., Rodríguez, S., Guerra, J. C., Gómez-Peláez, A. J., Alonso-Pérez, S., Bustos, J., and Milford, C.: Assessment of atmospheric processes driving ozone variations in the subtropical North Atlantic free troposphere, *Atmos. Chem. Phys.*, 13, 1973-1998, doi:10.5194/acp-13-1973-2013, 2013.
- Gaudel, A., O. R. Cooper, G. Ancellet, B. Barret, A. Boynard, J. P. Burrows, C. Clerbaux, P.-F. Coheur, J. Cuesta, E. Cuevas, S. Doniki, G. Dufour, F. Ebojje, G. Foret, O. Garcia, M. J. Granados-Muñoz, J. W. Hannigan, F. Hase, B. Hassler, G. Huang, D. Hurtmans, D. Jaffe, N. Jones, P. Kalabokas, B. Kerridge, S. Kulawik, B. Latter, T. Leblanc, E. Le Flochmoën, W. Lin, J. Liu, X. Liu, E. Mahieu, A. McClure-Begley, J. L. Neu, M. Osman, M. Palm, H. Petetin, I. Petropavlovskikh, R. Querel, N. Rahpoe, A. Rozanov, M. G. Schultz, J. Schwab, R. Siddans, D. Smale, M. Steinbacher, H. Tanimoto, D. W. Tarasick, V. Thouret, A. M. Thompson, T. Trickl, E. Weatherhead, C. Wespes, H. M. Worden, C. Vigouroux, X. Xu, G. Zeng, J. Ziemke: The Tropospheric Ozone Assessment Report: Present-day distribution and trends of tropospheric ozone relevant to climate and global atmospheric chemistry model evaluation, *Elem Sci Anth*, 6: 39. DOI: <https://doi.org/10.1525/elementa.291>, 2018.
- González, Y., Levels and origin of reactive gases and their relationship with aerosols in the proximity of the emission sources and in the free troposphere at Tenerife, PhD Thesis, Technical Note N° 12, AEMET, NIPO 281-12-016-1, July 2012.
- Huang, G., Liu, X., Chance, K., Yang, K., Bhartia, P. K., Cai, Z., Allaart, M., Ancellet, G., Calpini, B., Coetzee, G. J. R., Cuevas-Agulló, E., Cupeiro, M., De Backer, H., Dubey, M. K., Fuelberg, H. E., Fujiwara, M., Godin-Beekmann, S., Hall, T. J., Johnson, B., Joseph, E., Kivi, R., Kois, B., Komala, N., König-Langlo, G., Laneve, G., Leblanc, T., Marchand, M., Minschwaner, K. R., Morris, G., Newchurch, M. J., Ogino, S.-Y., Ohkawara, N., Piders, A. J. M., Posny, F., Querel, R., Scheele, R., Schmidlin, F. J., Schnell, R. C., Schrems, O., Selkirk, H., Shiotani, M., Skrivánková, P., Stübi, R., Taha, G., Tarasick, D. W., Thompson, A. M., Thouret, V., Tully, M. B., Van Malderen, R., Vömel, H., von der Gathen, P., Witte, J. C., and Yela, M.: Validation of 10-year SAO OMI Ozone Profile (PROFOZ) product using ozonesonde observations, *Atmos. Meas. Tech.*, 10, 2455-2475, <https://doi.org/10.5194/amt-10-2455-2017>, 2017.
- Schultz, M. G., Schröder, S., Lyapina, O., Cooper, O. R., Galbally, I., Petropavlovskikh, I., von Schneidmesser, E., Tanimoto, H., Elshorbany, Y., Naja, M., Seguel, R. J., Dauert, U., Eckhardt,

- P., Feigenspan, S., Fiebig, M., Hjellbrekke, A.-G., Hong, Y.-D., Kjeld, P. Ch., Koide, H., Lear, G., Tarasick, D., Ueno, M., Wallasch, M., Baumgardner, D., Chuang, M.-T., Gillett, R., Lee, M., Molloy, S., Moolla, R., Wang, T., Sharps, K., Adame, J.A., Ancellet, G., Apadula, F., Artaxo, P., Barlasina, M.E., Bogucka, M., Bonasoni, P., Chang, L., Colomb, A., Cuevas-Agulló, E., Cupeiro, M., Degorska, A., Ding, A., Fröhlich, M., Frolova, M., Gadhavi, H., Gheusi, F., Gilge, S., Gonzalez, M.Y., Gros, V., Hamad, S.H. Helmig, D., Henriques, D., Hermansen, O., Holla, R., Hueber, J., Im, U., Jaffe, D.A.; Komala, N., Kubistin, D., Lam, K.-S., Laurila, T., Lee, H., Levy, I., Mazzoleni, C., Mazzoleni, L., McClure-Begley, A., Mohamad, M., Murovec, M., Navarro-Comas, M., Nicodim, F., Parrish, D., Read, K.A., Reid, N., Ries, L., Saxena, P., Schwab, J.J., Scorgie, Y., Senik, I., Simmonds, P., Sinha, V., Skorokhod, A.I., Spain, G., Spangl, W., Spoor, R., Springston, S.R., Steer, K., Steinbacher, M., Suharguniyawan, E., Torre, P., Trickl, T., Weili, L., Weller, R., Xu, X., Xue, L., Zhiqiang, M.: : Tropospheric Ozone Assessment Report, links to Global surface ozone datasetsx. PANGAEA, <https://doi.org/10.1594/PANGAEA.876108>, Supplement to: Schultz, MG et al. (2017): Tropospheric Ozone Assessment Report: Database and Metrics Data of Global Surface Ozone Observations, *Elementa - Science of the Anthropocene*, 5:58, 26 pp, <https://doi.org/10.1525/elementa.244>, 2017.
- Smit, H. G. J., Oltmans, S., Deshler, T., Tarasick, D., Johnson, B., Schmidlin, F., Stübi, R., and Davies, J.: SI2N/O3S-DQA Activity: Guide Lines for Homogenization of Ozone Sonde Data, version 19 November 2012, available at: http://www-das.uwyo.edu/~deshler/NDACC_O3Sondes/O3s_DQA/O3S-DQA-Guidelines%20Homogenization-V2-19November2012.pdf, 2012.
- Smit, H.G.J., and the Panel for the Assessment of Standard Operating Procedures for Ozonesondes (ASOPOS), Quality Assurance and Quality Control for Ozone Sonde Measurements in GAW, GAW Report No. 201, World Meteorological Organization (WMO), 92 pp, 2013.

5.5 Staff

- Carlos Torres (AEMET; Head of programme)
- Dr Emilio Cuevas (AEMET)
- Dr Natalia Prats (AEMET)
- Ramón Ramos (AEMET; Head of Infrastructure)
- Sergio Afonso (AEMET; Meteorological Observer-GAW Technician)
- Virgilio Carreño (AEMET; Meteorological Observer-GAW Technician)
- Nayra Chinaa (SIELTEC Canarias / TRAGSATEC; Calibrations and ozonesonde technician)

6 Total Ozone Column and Ultraviolet Radiation

6.1 Main Scientific Goals

The main scientific objective of this programme is to obtain the total ozone column (TOC) and ultraviolet (UV) spectral radiation with the highest precision and long-term stability that the current technology and scientific knowledge allows to achieve. To reach this objective the group uses three interconnected areas. The base is the instrumentation; this is supported by strict QA/QC protocols that require laboratory calibrations and theoretical modelling. Finally, web-oriented [databases](#) are developed for dissemination of the observational data.

6.2 Measurement Programme

Measurements of total ozone and spectral ultraviolet radiation began in May 1991 in IZO with the installation of Brewer spectrometer #033. Ozone profile measurements were added in September 1992 with two daily (sunrise and sunset) vertical ozone profiles obtained with the Umkehr technique. In July 1997, a double Brewer #157 was installed at IZO and it ran in parallel with Brewer #033 for six months. In 2003, a second double Brewer #183 was installed and it was designated the travelling reference of the Regional Brewer Calibration Center for Europe (RBCC-E).



Figure 6.1. Members of the Total Ozone and UV radiation programme with the RBCC-E Brewer spectrophotometer triad located at IZO. Left to right: Virgilio Carreño, Francisco Parra Rojas, Alberto Redondas, Sergio León Luis, and Javier López Solano.

In 2005, a third double Brewer #185 was installed and it completes the reference triad of the RBCC-E (Fig. 6.1). The measurement programme was completed with the installation of a Pandora spectroradiometer in October 2011. The technical specifications of both Brewer and Pandora instruments are summarized in Table 6.1.

Table 6.1. Spectrometer specifications.

Brewer	
Slit Wavelengths	O ₃ (nm): 303.2 (Hg slit), 306.3, 310.1, 313.5, 316.8, 320.1
Mercury-calibration (O ₃ mode)	302.15 nm
Resolution	0.6 nm in UV; approx 1nm in visible
Stability	±0.01 nm (over full temperature range)
Precision	0.006 ± 0.002 nm
Measurement range (UVB)	286.5 nm to 363.0 nm (in UV)
Exit-slit mask cycling	0.12 sec/slit, 1.6 sec for full cycle
O ₃ measurement accuracy	±1% (for direct-sun total ozone)
Ambient operating temperature range	0°C a +40°C (no heater) -20°C a +40°C (with heater option) -50°C a +40°C (with complete cold weather kit)
Physical dimensions (external weatherproof container)	Size: 71 by 50 by 28 cm Weight: 34 kg
Power requirements Brewer and Tracker	3A @ 80 to 140 VAC (with heater option) 1.5A @ 160 to 264 VAC 47 to 440 Hz
Pandora	
Instrument spectral range	265-500 nm
Spectral window for NO ₂ fit	370-500 nm
Spectral resolution	±0.4 nm
Total integration time	20 s
Number of scans per cycle	50-2500
Spectral sampling of the grating spectrometers	3 pixels per Full Width at Half Maximum (FWHM)

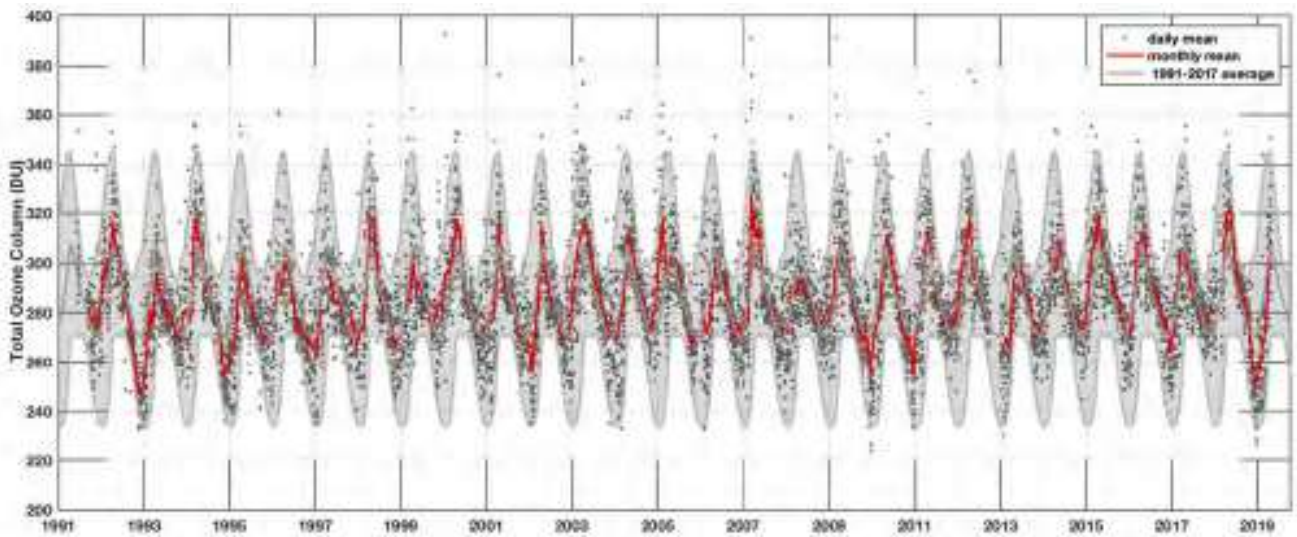

Figure 6.2. Total Ozone series at Izaña Atmospheric Observatory (1991-2018), daily mean (in grey dots) and monthly mean (in red), the long-term mean from the period 1991-2018 are also shown (grey line) with the shaded area corresponding to the standard deviation in the long term mean.

The spectral UV measurements are routinely quality controlled using IZO calibration facilities. The stability and performance of the UV calibration is monitored by 200W lamp tests twice a month. Every six months the Brewers are calibrated in a laboratory darkroom, against 1000W DXW lamps traceable to the World Radiation Center (WRC) standards. The SHICrvm software tool is used to analyse quality aspects of measured UV-spectra before data transfer to the databases. In addition, model to measurements comparisons are regularly done. Every year the Brewer #185 is compared with the Quality Assurance of Spectral Ultraviolet Measurements (QASUME) International portable reference spectroradiometer from Physikalisch-Meteorologisches Observatorium Davos, World Radiation Center (PMOD/WRC).

Concerning total ozone, the Brewer triad has an exhaustive quality control in order to assure the calibration, with routine calibrations performed on a monthly basis. With this procedure, we have achieved a long-term agreement between the instruments of the triad with a precision of less than 0.25% in ozone.

The Total Ozone programme is a part of the NDACC programme. The total ozone series for 1991-2018 is shown in Fig. 6.2 and is available at the NDACC website and at the World Ozone and Ultraviolet Data Center (WOUDC). We show also in Fig. 6.3 the UV observations obtained from Brewer spectrophotometer #157, available also at the WOUDC.

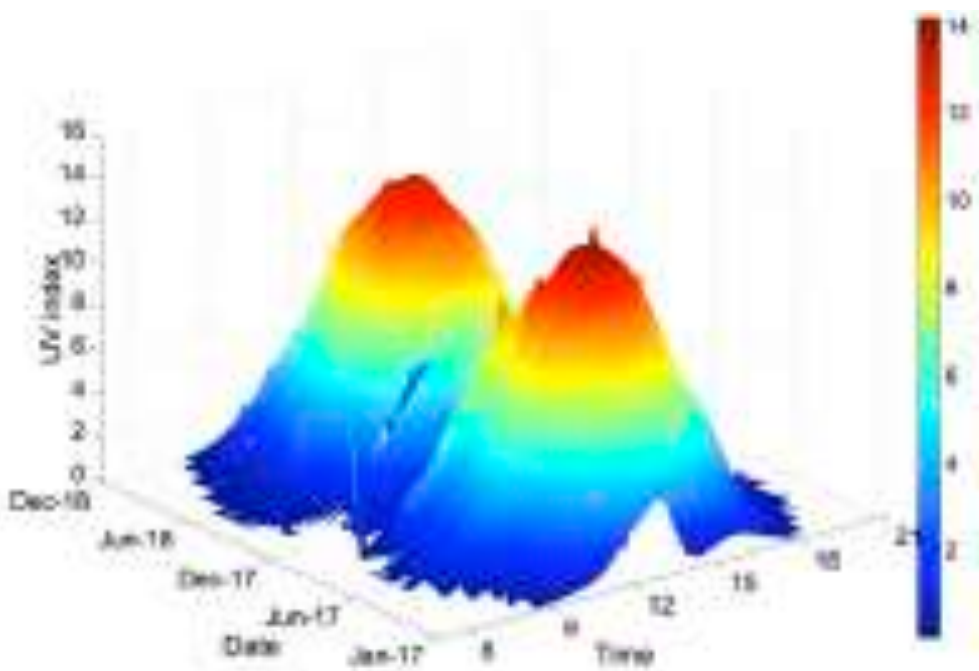

Figure 6.3. UV index during 2017-2018 obtained from Brewer #157 at Izaña Atmospheric Observatory.

6.3 Participation in scientific projects and campaigns/experiments during the period 2017-2018

The participation in scientific projects of this measurement programme are intertwined with the activities of the Regional Brewer Calibration Center for Europe (RBCC-E) (see Section 17 for more details).

6.3.1 EUBREWNET

The Vienna Convention for the Protection of the Ozone Layer and the subsequent Montreal Protocol on Substances that Deplete the Ozone Layer have been among the most successful environmental agreements the nations of the world have entered into and have now almost completely eliminated the production of human-made "Ozone Depleting Substances". This has led to the halting of the rapid decline of ozone observed in the 1980s and 1990s, with some promising early indications of ozone recovery now being apparent. It is therefore important to continue to measure carefully the state of the global ozone layer in the coming decades, noting also that stratospheric conditions are expected to change with the projected increasing concentration of greenhouse gases, and the fact that stratospheric ozone itself has a significant effect on the atmospheric radiation balance and surface climate. For this reason, the Vienna Convention obliges signatory countries to maintain programmes to systematically monitor stratospheric ozone.

The Brewer Ozone Spectrophotometer has, for the last 30 years, been the instrument of choice for ground station measurements of ozone and, in an effort to significantly improve the quality and timeliness of the data. The European Cooperation in Science and Technology (COST) Action (ES1207) was active from April 2013 to July 2017 to form a European Brewer Network – [EUBREWNET](#). The results of this COST Action have been presented in Rimmer, Redondas, and Karppinen (2018).

Since the end of 2018, support to EUBREWNET has been provided by AEMET. The activities carried out are overseen by a committee within the WMO SAG Ozone, which includes J. Rimmer (University of Manchester, UK), A. Redondas (Izaña Atmospheric Research Centre, AEMET, Spain), T. Kralidis (WOUDC), M. Tully (O₃ SAG Chair), and C. Sinclair (UV SAG Chair). Further input is provided by EUBREWNET's Management Committee, consisting of J. Rimmer (University of Manchester, UK), A. Redondas (Izaña Atmospheric Research Centre, AEMET, Spain), A.F. Bais (Aristotle University of Thessaloniki, Greece), J. Gröbner (Physikalisch - Meteorologisches Observatorium Davos/World Radiation Center, Switzerland), T. Karppinen (Finnish Meteorological Institute, Arctic Research Center, Finland), and V. de Book (Royal Meteorological Institute of Belgium, Belgium).



Figure 6.4. Location of Brewer stations currently participating in EUBREWNET. The network started as a European network but now includes close to 50 stations located world-wide.

EUBREWNET relies on the work of two European calibration Centers, the RBCC-E and the WRC. The RBCC-E plays a key role in EUBREWNET, coordinating the standardization of operation, characterization and calibration of the network instruments as well as providing the Brewer database. Now recognised by the WMO and the International Ozone Commission (IO3C), it represents an extremely valuable network of ground station data points without which the space-borne instruments would not be able to function with any degree of accuracy. In the current times when we are trying to identify ozone recovery rates of 1% per decade, it is highly important that data are both accurate and consistent across all stations.

The purpose of EUBREWNET is to harmonise observations, data processing, calibrations and operating procedures so that a measurement at one station is entirely consistent with measurements at all the others. Additionally, the Brewer spectrophotometers are also used to measure spectral UV irradiance, the sulphur dioxide column and aerosol optical depth. Some Brewer spectrophotometers are also able to measure the nitrogen dioxide column. This harmonised Brewer network (Fig. 6.4) constitutes the largest harmonised ground based UV network in the world, available for assimilation into satellite retrievals and models to greatly improve accuracy of the satellite data and forecasting. Another important point is the link to climate change where tropospheric ozone and aerosols are still regarded as having the largest effect on uncertainties in climate models. The Brewer instruments are suitable for the measurement of total column ozone which includes both tropospheric and stratospheric ozone whereas satellites struggle with the lower altitudes.



Figure 6.5. EUBREWNET database architecture.

The actual implementation of the network (see Fig. 6.5) can be summarized as follows:

- Automated data transfers to central database started in September 2014. Data submission now became automatic with little operator involvement so improving overall submission rates.
- Calibration data are stored in a central database. This allows for central processing of all stations' data so ensuring consistency and use of up-to-date calibration and processing.

- Site characterisation. Central data processing in addition to station processing: including part of QC by comparison and state of the art algorithms.
- Central re-processing. Historical data or changes in constants recommended by WMO Ozone SAG.
- Central QA/QC systems (QA/QC validated in one place) stations with a problem can be easily identified.
- Near Real Time (NRT) data. Essential for NRT validation of satellite data and model assimilations.

As mentioned previously, support to EUBREWNET has been provided by AEMET since the end of the year 2018. The activities planned for the three-year period 2018-2021 include the implementation of:

- an automatic submission system for the level 1.0 and 1.5 ozone products to the WMO World Ozone and Ultraviolet Radiation Data Centre.
- an automatic submission system for the NRT ozone data to the NDACC database.
- the level 1.5 NRT UV product.
- the level 1.5 NRT AOD product.

Rimmer et al. (2017) presented an overview of the European COST Action EUBREWNET to the United Nations Environment Programme (UNEP) Ozone Secretariat “10th meeting of the Ozone Research Managers of the Parties to the Vienna Convention”, which was held in Geneva, 28-30 March 2017. At the same meeting Redondas (2017a) presented the South Europe Regional Report.

During 2017-2018, in the framework of EUBREWNET we participated in the following scientific peer reviewed publications (Lakkala et al., 2018a; León-Luis et al., 2018a; López-Solano et al., 2018; Redondas et al., 2018a, 2018b; Rimmer et al., 2018; and Zerefos et al., 2017) and in various conferences and workshops (e.g. León-Luis et al., 2018b, 2018c; López-Solano et al., 2018b). For further details on the results of the

In addition, during 2017-2018 EUBREWNET has facilitated other scientific studies (e.g. Carlund et al., 2017; Siani et al., 2018; Stübi et al., 2017). A full list of EUBREWNET related publications is available [here](#).

Finally, it should be noted that EUBREWNET, in conjunction with WMO/UNEP, is very active in the areas of capacity building, particularly in Article 5 countries. This includes the organization of operator courses and workshops, which provide expert instruction and knowledge exchange using the considerable expertise within EUBREWNET (see Section 17.5.5 for further details).

6.3.2 Detection of volcanic SO₂ with Brewer spectrophotometers

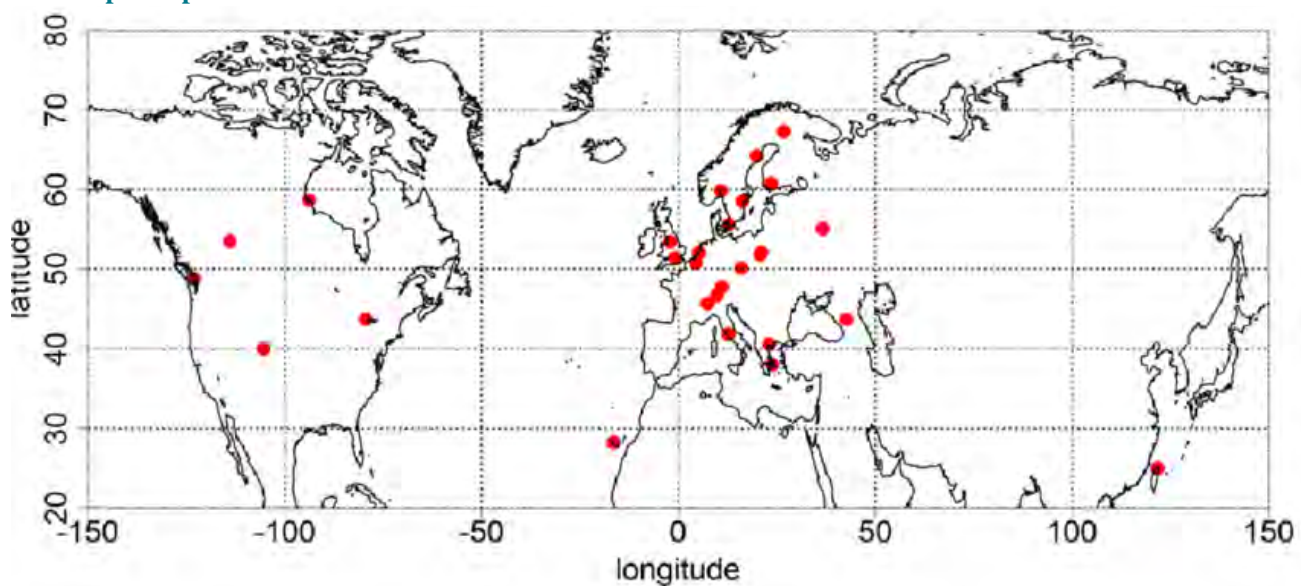

Figure 6.6. All stations with accessible SO₂ column data from Brewers analysed in this study. Reprinted from Zerefos et al., (2017).

IARC contributed to a study utilising Brewer sulphur dioxide column data (Fig. 6.6), demonstrating that SO₂ columnar amounts have significantly increased following the five largest volcanic eruptions of the past decade in the Northern Hemisphere (Zerefos et al., 2017). A strong positive signal was detected by all the existing networks either ground based (Brewer, EARLINET, AirBase) or from satellites (OMI, GOME-2).

The study particularly examines the adequacy of the existing Brewer network to detect SO₂ plumes of volcanic origin in comparison to other networks and satellite platforms. The comparison with OMI and GOME-2 SO₂ space-borne retrievals shows statistically significant agreement between the Brewer network data and the collocated satellite overpasses. It is shown that the Brewer instrument is capable of detecting significant columnar SO₂ increases following large volcanic eruptions, when SO₂ levels rise well above the instrumental noise of daily observations, estimated to be of the order of 2 DU.

A model exercise from the MACC project shows that the large increases of SO₂ over Europe following the Bárðarbunga eruption in Iceland were not caused by local sources or ship emissions but are clearly linked to the eruption. Zerefos et al. (2017) proposed that by combining Brewer data with that from other networks and satellites, a useful tool aided by trajectory analyses and modeling could be created to forecast high SO₂ values both at ground level and in air flight corridors following future eruptions.

6.3.3 ATMOZ

The European Metrology Research Programme (EMRP) Traceability for atmospheric total column ozone (ATMOZ) Joint Research Project was initiated to significantly enhance the reliability of total ozone column measured at the Earth surface. ATMOZ started in 2014 and finished in 2017. This project has made significant improvements in explaining differences and quantifying the corresponding uncertainties of the worldwide monitoring total ozone column Brewer network, with an overall uncertainty of around 1% - 2%.

The analysis carried out in this project of the main instruments used in the observation networks (Dobson and Brewer), included bandwidths, operational temperature corrections and stray-light corrections. This study led to an improved consistency between these instruments and the reference Brewer spectrophotometer from RBCC-E. This project has also provided the technical and research fundament of replacing ageing instruments with more cost effective, robust and accurate instrumentations of newest generation for detecting the recovery of the world-wide ozone shield during the next decades.

A newly developed high-precision and low-noise spectroradiometer was shown to be suitable as a future reference instrument for ozone retrieval using the full spectrum in the UV band. The ground-based solar irradiance measured during the ATMOZ campaign at the Izaña Observatory that took place in 2016, allowed a high-resolution extraterrestrial solar spectrum to be determined (Gröbner et al., 2017a). This spectrum will be used to homogenise total ozone column retrievals.

The final report of the project (Gröbner et al., 2017b) is available [here](#). IARC participated in various ATMOZ publications during 2017-2018 (e.g. Berjón et al., 2018; El Gawhary et al., 2017a; Fountoulakis et al., 2017 and Köhler et al., 2018). The final ATMOZ workshop was held at El Arenosillo on 2 June 2017 during the 12th RBCC-E Calibration Campaign (see Section 17.5.5 for more details). IARC participated in various presentations at this workshop (Berjón et al., 2017; El Gawhary et al., 2017b; Redondas 2017b and Redondas et al., 2017). The presentations of this workshop can be found [here](#).

6.3.4 Pandonia Global Network



The Pandora Spectrometer System is a ground-based, sun/sky/lunar passive remote sensing instrument for the retrieval of trace gases in the UV/Vis spectral wavelengths. It was developed in 2005 by NASA and the Sciglob company, and since that time the Pandora spectrometer system has evolved, with the participation in a series of field campaigns such as DISCOVER-AQ, CINDI 1&2, ATMOZ 2016, and the 2018 OWLETS and LISTOS campaigns. The Pandonia Network, funded by ESA through the LuftBlick company, has unified the operative and calibration procedures for the pandora instruments since 2011.

NASA and ESA are currently collaborating to coordinate an expanding global network of standardized, calibrated Pandora instruments focused on air quality and atmospheric composition. With this collaboration the Pandonia Network has become the [Pandonia Global Network \(PGN\)](#), which emphasizes: homogeneous calibration of instrumentation, low instrument manufacturing and operation costs, remote operative assistance, and central data processing and formatting for near real time delivery of final data products.



Figure 6.7. Daniel Santana and the Pandora 121 mounted at IZO.

A major joint objective is to support the validation and verification of more than a dozen Low Earth Orbit (LEO) and Geostationary Orbit (GEO) satellites, most notably Sentinel 5P, TEMPO, GEMS and Sentinel 4.

PGN participants are primarily comprised of governmental and academic researchers and technicians. The launch of the PGN in early 2018 represents a programmatic shift by NASA and ESA away from primarily operating and supporting in research and field campaign mode to establishing long-term fixed locations that are focused on providing long-term quality observations of total column and vertically resolved concentrations of a range of trace gases. The major trace gases observed by the Pandora systems across the range of 280 - 530 nm include: O₃, NO₂, HCHO, SO₂ and BrO.

The reference instruments of the Pandonia Global Network will be installed at IZO, where there are already two instruments installed: Pandora 121 (Pandora 2s model, UV+VIS spectrometers, installed in April 2016) and the Pandora 101 (Pandora 1s model, UV only, installed in July 2011, but with a major hardware upgrade in July 2017). The Izaña Atmospheric Observatory is also an instrument test site together with the observation platform of the Biomedical Physics Department, Medical University Innsbruck, Austria. All the network instruments will be traceable to the reference instruments, through intercomparison with a mobile reference unit visiting network locations, while the IZO instruments will be regularly calibrated by Langley calibrations.

In order to evaluate the results of the future Langley calibrations with respect to the official calibration methods of the pandora instruments, a first re-analysis and correction of the official calibration files of the Pandora 101 has been performed. The following operational periods have been identified within the period 19/07/2011, the date the Pandora 101 was installed at IZO, to 1/07/2017, when the instrument was finally dismantled to obtain an important hardware update (Table 6.2).

The gas retrieval algorithm of the Pandora data is based on the DOAS method, in which the absorption features in the measured spectra are compared with an absorption free reference spectrum to determine the amount of trace gases present in the atmosphere.

Table 6.2. Operational periods in the Pandora 101 time series.

Period	Starting date	Maintenance action
1	20110719	Installed on IZO platform
2	20110829	Fibre unplugged
3	20111104	Fibre unplugged
4	20120301	Installed on IZO tower
5	20121003	Change in the operation file 14bits to 16bits ADC
6	20130306	Fibre unplugged
7	20151020	Fibre unplugged
8	20160302	Fibre unplugged
9	20160601	Fibre unplugged
10	20170620	Change in operating temperature

The Pandora official processing utilised two main configurations for the analyzed period dates, Fitting Window 2 (FW2) to process NO₂ vertical columns and Fitting Window 5 (FW5) to process ozone vertical column amounts, in Dobson Units.

The O₃ (FW5) uses a theoretical reference spectrum (Kurucz et al. 2005) normalized to the Thuillier et al. (2004) spectrum with the cross section provided by GOME, at 225K of O₃ effective temperature.

The NO₂ (FW2) uses a synthetic reference spectrum (this is, an absorption free reference spectrum created with measurements of the instrument itself, by using the Modified Langley Extrapolation method), with the cross section provided by Vandaele et al. (1998), at 254.5 K of NO₂ effective temperature.

The maintenance actions in the Pandora instruments (see Table 6.2) such as unplugging the optical fibres when unmounting the instrument due to adverse weather conditions, creates a wavelength shift in the measured spectra, and also a change in the instrument sensitivity, due to a non perfect re-attachment position of the fibre, after each unplug.

In the case of the O₃ (FW5), the corrections that can be done in the calibration file after these events, is a correction of the dispersion polynomial for each period. For the NO₂ (FW2) the correction is performed on the dispersion polynomial but also by re-generating the synthetic reference spectrum with field data of the corresponding periods, in such a way that the change of sensitivity affecting the new measurements can be compensated with a new reference spectrum. More details about the Pandora calibration procedures can be found in the Blick Software Suite Manual (Cede, 2019).

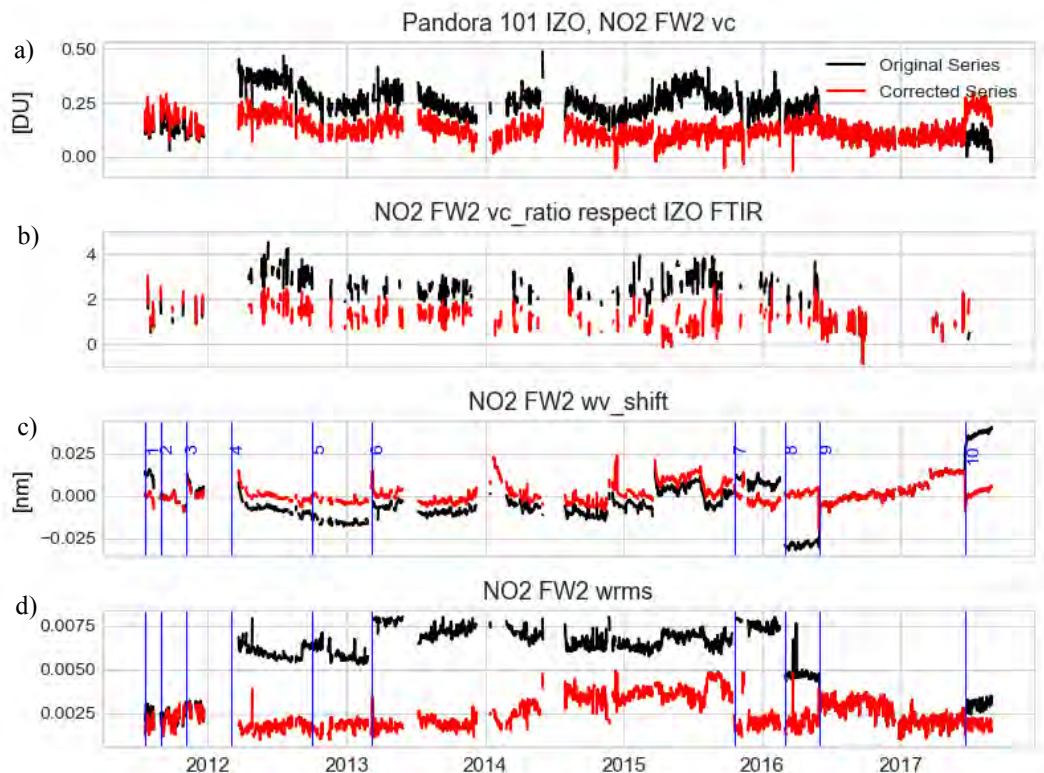

Figure 6.8. Daily means of Pandora 101 a) NO₂ vertical column, b) NO₂ vertical column ratio with respect to the IZO FTIR, c) NO₂ wavelength shift and d) wrms of the NO₂ data. Black dots correspond to the original data set, red dots correspond to the new corrected data set. Vertical lines are shown in the *wv_shift* and *wrms* plots to indicate the dates in which a correction was needed.

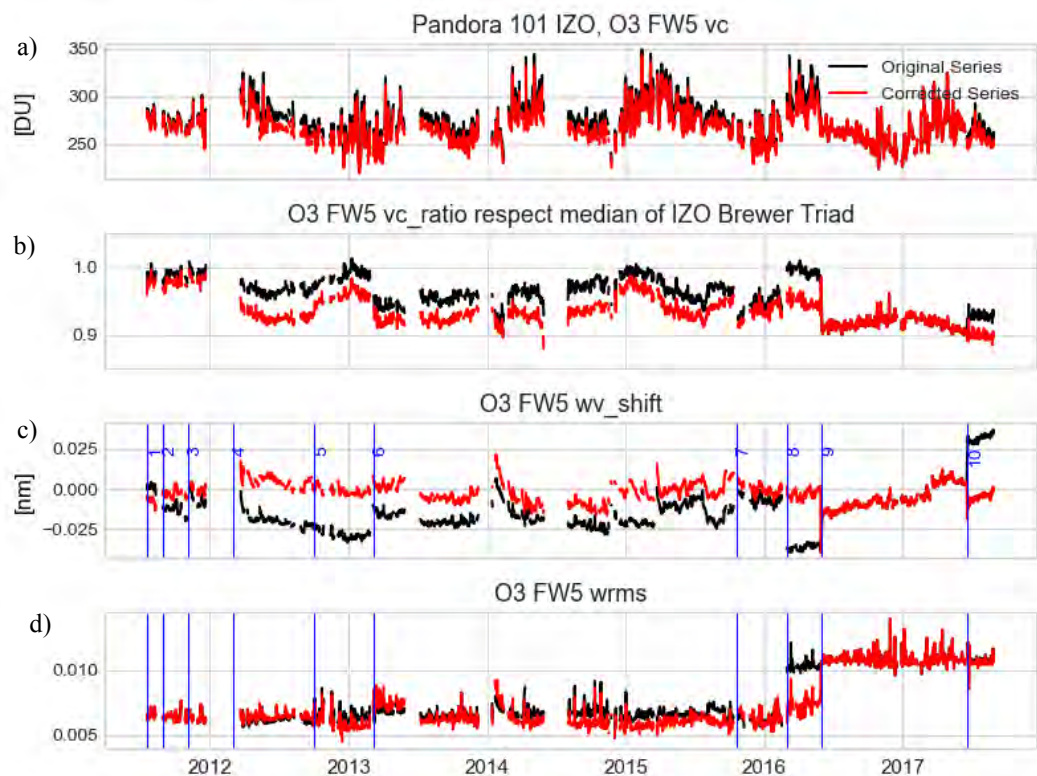

Figure 6.9. Daily means of Pandora 101 a) ozone vertical column, b) ozone vertical column ratio with respect to the RBCCE IZO Brewer triad median, c) ozone wavelength shift and d) wrms of the O₃ data. All Pandora 101 ozone data is processed with the FW5 configuration. Black dots correspond to the original data set, red dots correspond to the new corrected data set. Vertical lines are shown in the *wv_shift* and *wrms* plots to indicate the dates in which a correction was needed.

Table 6.3. Statistics of the original versus corrected Pandora P101 NO₂ (FW2) data series.

Period	Mean (original)	Std (original)	Mean (corrected)	Std (corrected)
NO ₂ Vertical Column (DU)	0.216	0.091	0.130	0.050
Pandora/FTIR <i>vc_ratio</i>	2.345	0.887	1.203	0.563
Wavelength shift (nm)	-0.002	0.013	0.001	0.006
Gas retrieval fitting wrms	0.005	0.002	0.003	0.001

Table 6.4. Statistics of the original versus corrected Pandora P101 O₃ (FW5) data series.

Period	Mean (original)	Std (original)	Mean (corrected)	Std (corrected)
O ₃ Vertical Column (DU)	274.224	19.067	267.852	17.353
Pandora/Brewer <i>vc_ratio</i>	0.956	0.027	0.934	0.021
Wavelength shift (nm)	-0.014	0.014	-0.003	0.006
Gas retrieval fitting wrms	0.008	0.002	0.007	0.002

The maintenance periods can be identified by looking for step changes in the gas retrieval parameters such as the wavelength shift (wv_shift), which is how shifted are the measured spectra with respect to the fraunhofer lines of the sun, or the weighted root mean square (wrms) of the gas retrieval fitting which gives an estimation of the DOAS algorithm certainty in each measurement.

In the case of NO₂, by applying the needed corrections in the calibration files for each period, both the wavelength shift and wrms were improved, and the mean vertical column ratio with respect to the FTIR instrument installed at IZO was reduced from 2.3 to 1.2, with an improved standard deviation that was reduced from 0.09 to 0.05 (Fig. 6.8, Table 6.3). In most of the cases, the step changes in the NO₂ vertical column data between different periods were removed after the corrections. The only period which could not be completely fixed is the last one (20170620) in which a change of the instrument operating temperature from 20 deg to 15 deg together with a non fully characterized temperature dependence of the instrument, made it impossible to correct.

In the case of O₃, by applying the needed corrections in the calibration files for each period, both the wavelength shift and wrms were improved (Fig. 6.9, Table 6.4). The standard deviation of the vertical column amount was also reduced, but the vertical column ratio with respect to the RBCCE IZO Brewer triad median changed from a ratio of 0.956 to 0.934. The most probable reasons explaining this offset are the different cross sections and effective ozone temperatures used in the Pandora with respect to the brewers. The step changes in all the Pandora data parameters could be reduced, but less than in the case of NO₂, because in this case the theoretical reference spectrum used for O₃ is always the same, and it does not follow the changes in the sensitivity of the instrument for every period. In contrast to NO₂ in which a synthetic reference is used which is re-generated for every period.

The new corrected data series for the Pandora101 will be used as a reference, to develop and compare the results of the future Langley calibrations of the Pandora Instruments at IZO, which will allow to build synthetic reference spectrums not only for NO₂, but also for O₃.



Figure 6.10. Pandora 101 mounted at IZO.

6.4 Collaborations with other scientific programmes

Collaborations with other scientific programmes at IARC during 2017-2018 included the following:

- Long-term Monitoring of Greenhouse Gases at the Izaña Atmospheric Observatory (García et al., 2018a)
- Comparison of observed and modeled cloud-free longwave downward radiation (2010–2016) at the high mountain BSRN Izaña station (García et al., 2018b)
- Description of the Baseline Surface Radiation Network (BSRN) station at the Izaña Observatory (2009–2017): measurements and quality control/assurance procedures (García et al., 2018c)
- Status of the Izaña BSRN station in July 2018 (García et al., 2018d)
- Improved Retrieval Strategy for Ozone Monitoring by Ground-Based FTIR Spectrometry (Sanromá et al., 2017).

6.5 References

- Berjón, A., Redondas, A., Sildoja M-M, Nevas S, Carreno V, Santana-Díaz D, Hernández-Cruz B, León-Luis SF, López-Solano J. Temperature characterisation of Brewer determined in the laboratory. Talk presented at the ATMOZ Final Workshop, Huelva, Spain, 2 June 2017. (Available at: https://projects.pmodwrc.ch/atmoz/images/huelva_workshop/3.pdf)
- Berjón, A., Redondas, A., Sildoja, M.-M., Nevas, S., Wilson, K., León-Luis, S. F., El Gawhary, O., and Fountoulakis, I. Sensitivity study of the instrumental temperature corrections on Brewer total ozone column measurements, *Atmos. Meas. Tech.*, <https://doi.org/10.5194/amt-11-3323-2018>, 11, 3323-3337, 2018.
- Carlund, T., Kouremeti, N., Kazadzis, S. and Gröbner, J.: Aerosol optical depth determination in the UV using a four-channel precision filter radiometer, *Atmos. Meas. Tech.*, 10(3), 905–923, doi:10.5194/amt-10-905-2017, 2017.
- Cede, A., Manual for Blick Software Suite 1.6. Available at: http://pandonia.net/media/documents/BlickSoftwareSuite_Manual_v11.pdf, 2019.
- El Gawhary, O., Van der Leden, N., Berjón, A., Redondas, A., Egli, L., Kröger, I., Sperfeld, P., and Gröbner, J.; Operation of a wavelength ruler for the characterization of spectroradiometers for O₃ measurement at the 2016 Izaña field campaign, *UVNews* 12, 29–31, 2017a. (Available at: <http://metrology.tkk.fi/uvnet/reports.htm>).
- El Gawhary O, Redondas A, Parra-Rojas F. Uncertainties in TOC retrieval for Brewer and Dobson data and the role of cross-correlations among influence parameters. Talk presented at the ATMOZ Final Workshop, Huelva, Spain, 2 June 2017b.
- Fountoulakis I., A. Redondas, K. Lakkala, A. Berjon, A.F. Bais, L. Doppler, U. Feister, A. Heikkila, T. Karppinen, J.M. Karhu, T. Koskela, K. Garane1, K. Fragkos, and V. Savastiouk. Temperature dependence of the Brewer global UV measurements. *Atmos. Meas. Tech.*, <https://doi.org/10.5194/amt-10-4491-2017>, 10, 4491-4505, 2017.

- García, O.E., E. Sepúlveda, E. Cuevas, A.J. Gómez-Peláez, M. Schneider, F. Hase, T. Blumenstock, A. Redondas, and V. Carreño, Long-term Monitoring of Greenhouse Gases at the Izaña Atmospheric Observatory, 14th International Workshop on Greenhouse Gas Measurements from Space (IWGGMS-14), Toronto (Canada), 8-10 May, 2018a.
- García, R. D., Barreto, A., Cuevas, E., Gröbner, J., García, O. E., Gómez-Peláez, A., Romero-Campos, P. M., Redondas, A., Cachorro, V. E., and Ramos, R. Comparison of observed and modeled cloud-free longwave downward radiation (2010–2016) at the high mountain BSRN Izaña station, *Geosci. Model Dev.*, <https://doi.org/10.5194/gmd-11-2139-2018>, 11, 2139–2152, 2018b.
- García, R. D., Cuevas, E., Ramos, R., Cachorro, V. E., Redondas, A., and Moreno-Ruiz, J. A.: Description of the Baseline Surface Radiation Network (BSRN) station at the Izaña Observatory (2009–2017): measurements and quality control/assurance procedures, *Geosci. Instrum. Method. Data Syst. Discuss.*, <https://doi.org/10.5194/gi-2018-41>, 2018c.
- García, R.D., E. Cuevas, R. Ramos, V.E. Cachorro, and A. Redondas, Status of the Izaña BSRN station in July 2018, 15th BSRN Scientific Review and Workshop at CIRES, Boulder CO, USA July, 16-20, 2018d.
- Gröbner, J., Kröger, I., Egli, L., Hülsen, G., Riechelmann, S., Sperfeld, P. The high-resolution extraterrestrial solar spectrum (QASUMEFTS) determined from ground-based solar irradiance measurements. *Atmos. Meas. Tech.*, 10, 3375–83, 2017a.
- Gröbner, J., Redondas, A., Weber, M., Bais, A. Final Publishable Report Traceability for atmospheric total column ozone (ENV59, ATMOZ). EURAMET; 2017b. (Available at: <https://www.euramet.org/research-innovation/search-research-projects/details/project/traceability-for-atmospheric-total-column-ozone/>)
- Köhler, U., Nevas, S., McConville, G., Evans, R., Smid, M., Stanek, M., Redondas, A., and Schönerborn, F.: Optical characterisation of three reference Dobsons in the ATMOZ Project – verification of G. M. B. Dobson's original specifications, *Atmos. Meas. Tech.*, 11, 1989–1999, <https://doi.org/10.5194/amt-11-1989-2018>, 2018.
- Kurucz, R. L. New atlases for solar flux, irradiance, central intensity, and limb intensity. *Memorie della Societa Astronomica Italiana Supplementi*, 8:189, 2005.
- Lakkala, K., Arola, A., Gröbner, J., León-Luis, S. F., Redondas, A., Kazadzis, S., Karppinen, T., Karhu, J. M., Egli, L., Heikkilä, A., Koskela, T., Serrano, A. and Vilaplana, J. M.: Performance of the FMI cosine error correction method for the Brewer spectral UV measurements, *Atmospheric Measurement Techniques*, 11(9), 5167–5180, [doi:https://doi.org/10.5194/amt-11-5167-2018](https://doi.org/10.5194/amt-11-5167-2018), 2018a.
- Lakkala, K., Redondas, A., Meinander, O., Thölix, L., Hamari, B., Almansi, A. F., Carreno, V., García, R. D., Torres, C., Deferrari, G., Ochoa, H., Bernhard, G., Sanchez, R., and de Leeuw, G. UV measurements at Marambio and Ushuaia during 2000–2010, *Atmos. Chem. Phys.*, <https://doi.org/10.5194/acp-18-16019-2018>, 18, 16019–16031, 2018b.
- León-Luis, S. F., Redondas, A., Carreño, V., López-Solano, J., Berjón, A., Hernández-Cruz, B., and Santana-Díaz, D., Internal consistency of the Regional Brewer Calibration Centre for Europe triad during the period 2005–2016. *Atmos. Meas. Tech.*, <https://doi.org/10.5194/amt-11-4059-2018>, 11, 4059–4072, 2018a.
- León-Luis, S.F., Carreño, V., Redondas, A., Santana-Díaz, D., López-Solano, J., Rodríguez-Válido, M. Centro de Calibración Regional Brewer – Europa (RBCC-E): Estabilidad de las medidas de ozono realizadas en el Observatorio Atmosférico de Izaña. Acta de las XXXV Jornadas Científicas de la Asociación Meteorológica Española. León, Spain, 5-7 March 2018, <https://doi.org/10.30859/ameJrCn35p213>, 2018b.
- León-Luis, S.F., Carreño, V., Redondas, A., Henriques, D., Moniz, L. Campaña intercomparación Brewer 2017: Calibración del Brewer #102. Acta de las XXXV Jornadas Científicas de la Asociación Meteorológica Española. León, Spain, 5-7 March 2018, <https://doi.org/10.30859/ameJrCn35p219>, 2018c.
- López-Solano, J., Redondas, A., Carlund, T., Rodríguez-Franco, J. J., Diémoz, H., León-Luis, S. F., Hernández-Cruz, B., Guirado-Fuentes, C., Kouremeti, N., Gröbner, J., Kazadzis, S., Carreño, V., Berjón, A., Santana-Díaz, D., Rodríguez-Valido, M., De Bock, V., Moreta, J. R., Rimmer, J., Smedley, A.R.D., Boulkelia, L., Jepsen, N., Eriksen, P., Bais, A. F., Shiroto, V., Vilaplana, J. M., Wilson, K. M., and Karppinen, T. Aerosol optical depth in the European Brewer Network, *Atmos. Chem. Phys.*, <https://doi.org/10.5194/acp-18-3885-2018>, 18, 3885–3902, 2018a.
- López-Solano, J., Redondas, A., Carlund, T., Rodríguez-Franco, J. J., Diémoz, H., León-Luis, S. F., Hernández-Cruz, B., Guirado-Fuentes, C., Kouremeti, N., Gröbner, J., Kazadzis, S., Carreño, V., Berjón, A., Santana-Díaz, D., Rodríguez-Valido, M., De Bock, V., Moreta, J. R., Rimmer, J., Smedley, A.R.D., Boulkelia, L., Jepsen, N., Eriksen, P., Bais, A. F., Shiroto, V., Vilaplana, J. M., Wilson, K. M., and Karppinen, T., UV Aerosol Optical Depth in the European Brewer Network, 9th International Workshop on Sand/Dust storms and Associated Dustfall, La Laguna, Tenerife, Spain, 22-24 May 2018b.
- Redondas, A. South Europe Regional Report: Armenia, Italy, Spain & Turkey. The 10th meeting of the Ozone Research Managers of the Parties to the Vienna Convention, Geneva, 28-30 March 2017a.
- Redondas, A. ATMOZ. Izaña Ozone Campaign. Talk presented at the ATMOZ Final Workshop, Huelva, Spain, 2 June 2017b. (Available at: https://projects.pmodwrc.ch/atmoz/images/huelva_workshop/9.pdf)
- Redondas, A., Santana-Díaz D, Cede A, Tiefengraber M. Pandonia updates and overview. Talk presented at the ATMOZ Final Workshop, Huelva, Spain, 2 June 2017. (Available at: https://projects.pmodwrc.ch/atmoz/images/huelva_workshop/11.pdf)
- Redondas, A., Carreño, V., León-Luis, S.F., Hernández-Cruz, B., López-Solano, J., Rodríguez-Franco, J.J., Vilaplana, J.M., Gröbner, J., Rimmer, J., Bais, A.F., Savastiouk, V., Moreta, J.R., Boulkelia, L., Jepsen, N., Wilson, K. M., Shiroto, V., and Karppinen, T. EUBREWNET RBCC-E Huelva 2015 Ozone Brewer Intercomparison, *Atmos. Chem. Phys.*, <https://doi.org/10.5194/acp-18-9441-2018>, 18, 9441–9445, 2018.
- Redondas, A., Nevas, S., Berjón, A., Sildoja, M.-M., León-Luis, S. F., Carreño, V., and Santana-Díaz, D. Wavelength calibration of Brewer spectrophotometer using a tunable pulsed laser and implications to the Brewer ozone retrieval, *Atmos. Meas. Tech.*, <https://doi.org/10.5194/amt-11-3759-2018>, 11, 3759–3768, 2018.
- Rimmer, J. S., Redondas, A., Groebner, J., Karppinen, T., de Bock, V., Bais, A. The European COST Action EUBrewNet: Towards consistency in quality control, quality assurance and coordinated operations of the Brewer Instrument. The 10th

meeting of the Ozone Research Managers of the Parties to the Vienna Convention, Geneva, 28 – 30 March 2017.

Rimmer, J. S., Redondas, A., and Karppinen, T. EuBrewNet – A European Brewer network (COST Action ES1207), an overview., *Atmos. Chem. Phys.*, 18, 10347-10353, <https://doi.org/10.5194/acp-18-10347-2018>, 2018.

Siani, A. M., Frasca, F., Scarlatti, F., Religi, A., Diémoz, H., Casale, G. R., Pedone, M. and Savastiouk, V.: Examination on total ozone column retrievals by Brewer spectrophotometry using different processing software, *Atmos. Meas. Tech.*, 11(9), 5105–5123, doi:10.5194/amt-11-5105-2018, 2018.

Stübi, R., Schill, H., Klausen, J., Vuilleumier, L. and Ruffieux, D.: Reproducibility of total ozone column monitoring by the Arosa Brewer spectrophotometer triad, *Journal of Geophysical Research: Atmospheres*, 122(8), 4735–4745, doi:10.1002/2016JD025735, 2017.

Thuillier, G., L Floyd, T N Woods, R Cebula, E Hilsenrath, M Hersé, and D Labs. Solar irradiance referencespectra for two solar active levels. *Advances in Space Research*, 34(2):256–261, 2004.

Vandaele, A.C., Hermans, C., Simon, P.C., Carleer, M., Colin, R., Fally, S., Mérienne, M.F., Jenouvrier, A., Coquart B. Measurements of the NO₂ absorption cross-section from 42 000 cm⁻¹ to 10 000 cm⁻¹ (238–1000 nm) at 220 K and 294 K. *Journal of Quantitative Spectroscopy and Radiative Transfer*, 59, 171-184, doi: 10.1016/S0022-4073(97)00168-4, 1998.

Zerefos, C. S., Eleftheratos, K., Kapsomenakis, J., Solomos, S., Inness, A., Balis, D., Redondas, A., Eskes, H., Allaart, M., Amiridis, V., Dahlback, A., De Bock, V., Diémoz, H., Engelmann, R., Eriksen, P., Fioletov, V., Gröbner, J., Heikkilä, A., Petropavlovskikh, I., Jarosławski, J., Josefsson, W., Karppinen, T., Köhler, U., Meleti, C., Repapis, C., Rimmer, J., Savinykh, V., Shirov, V., Siani, A. M., Smedley, A. R. D., Stanek, M., and Stübi, R.: Detecting volcanic sulfur dioxide plumes in the Northern Hemisphere using the Brewer spectrophotometers, other networks, and satellite observations, *Atmos. Chem. Phys.*, 17, 551-574, doi:10.5194/acp-17-551-2017, 2017.

6.6 Staff

Alberto Redondas Marrero (AEMET; Head of programme)

Virgilio Carreño (AEMET; Meteorological Observer-GAW Technician)

Dr Sergio Fabián León Luis (AEMET; Research Scientist)

Dr Alberto Berjón (TRAGSATEC; Research Scientist)

Dr Javier López Solano (TRAGSATEC; Research Scientist)

Daniel Santana Díaz (Sieltec/LuftBlick; Pandonia Global Network Operator/Research Scientist)

Dr Francisco Parra Rojas (UIAPR; Research Professor)

Bentorey Hernandez Cruz (ULL; Research Scientist) left IARC in July 2018

7 Fourier Transform Infrared Spectroscopy (FTIR)

7.1 Main Scientific Goals

Earth observations are fundamental for investigating the processes driving climate change and thus for supporting decisions on climate change mitigation strategies. Atmospheric remote sounding from space and ground are essential components of this observational strategy. In this context, the Fourier transform infrared spectroscopy (FTIR) programme at the IARC was established with the main goals of long-term monitoring of atmospheric gas composition (ozone related species and greenhouse gases) and the validation of satellite remote sensing measurements and climate models. In particular, within the FTIR programme much effort has been put in developing new strategies for observing tropospheric water vapour isotopologues from ground and space-based remote sensors, since these observations play a fundamental role for investigating the atmospheric water cycle and its links to the global energy and radiation budgets.

The FTIR programme at the IARC is the result of the close and long lasting collaboration of more than a decade between the IARC-AEMET and the [IMK-ASF-KIT](#) (Institute of Meteorology and Climate Research-Atmospheric Trace Gases and Remote Sensing, Karlsruhe Institute of Technology, Germany). The IMK-ASF has operated high-resolution ground-based FTS systems for almost two decades and they are leading contributors in developing FTIR inversion algorithms and quality control of FTIR solar measurements. As a result of this collaboration, the FTIR experiment at IZO has contributed to the prestigious international networks NDACC and TCCON since 1999 and 2007, respectively.

7.2 Measurement Programme

A ground-based high-resolution FTIR experiment (HR FTIR in the following) for atmospheric composition monitoring has two main components (Figure 7.1): a precise solar tracker that captures the direct solar light beam and couples it into a high-resolution Michelson interferometer (IFS). IARC's FTIR activities started in 1999 with a Bruker IFS 120M spectrometer, which was replaced by a Bruker IFS 120/5HR spectrometer in 2005 (see technical specifications in Table 7.1).

In order to derive trace gas concentrations from the recorded FTIR solar absorption spectra, synthetic spectra are calculated by the line-by-line radiative transfer model PRFWD (Schneider and Hase, 2009). Then, the synthetic spectra are fitted to the measured ones by the software package PROFFIT (PROFile FIT, Hase et al., 2004).



Figure 7.1. The ground-based FTIR experiment at the IARC (scientific container, upper panel, hosting the Michelson interferometer, lower panel).

PROFFIT allows to retrieve volume mixing ratio (VMR) profiles and to scale partial or total VMR profiles of several species simultaneously. There have been a lot of efforts for assuring and even further improving the high quality of the FTIR data products: e.g., monitoring the instrumental line shape (Hase et al., 1999), monitoring and improving the accuracy of the applied solar trackers (Gisi et al., 2011), as well as developing sophisticated retrieval algorithms (Hase et al., 2004). The good quality of these long-term ground-based FTIR data sets has been extensively documented by theoretical and empirical validation studies (e.g., Schneider et al., 2008; Schneider et al., 2010; García et al., 2012; Sepúlveda et al., 2012).



Figure 7.2. Installation of the EM27/SUN FTIR at the IARC.

In 2018 a portable and low-resolution FTIR spectrometer (LR FTIR in the following), the Bruker EM27/SUN, was acquired by the IARC within the Spanish infrastructure project (AEDM15-BE-3319) and installed at IZO in May 2018 (see Fig. 7.2). This instrument operates within the recently formed Collaborative Carbon Column Observing Network (COCCON, Frey et al., 2018) (see section 7.3.2).

Table 7.1. Technical Specifications for Bruker IFS 120/5HR (in brackets, if different for 120M).

Manufacturer, Model	Bruker, IFS 120/5HR [IFS 120M]
Spectral range (cm ⁻¹)	700 - 4250 (NDACC) and 3500 - 9000 (TCCON) Optional: 20 - 43000
Apodized spectral resolution (cm ⁻¹)	0.0025 [120M: 0.0035]
Resolution power ($\lambda/\Delta\lambda$)	$2 \cdot 10^5$ at 1000 cm ⁻¹
Typical Scan velocity (cm/s)	2.5 (scan time about 100 s @ 250 cm of Optical Path Difference)
Field of view (°)	0.2
Detectors	MCT and InSb (NDACC); InGaAs (TCCON)
Size (cm)/Weight (kg)/Mobility	320 x 160 x 100 [120M: 200 x 80 x 30] 550 + 70 (Pump) [120M: 100 + 30 (Electronics)] Installed inside container, limited mobility
Quality assurance system	Routine N ₂ O and HCl cell calibrations to determinate the Instrumental Line Shape

The FTIR programme at the IARC is complemented by two Picarro L2120-I δ D and δ 18O analysers installed at IZO and TPO within the European project [MUSICA](#) (see section 7.3.3). These instruments are based on the Wavelength-Scanned Cavity Ring-Down Spectroscopy (WS-CRDS) technology and are calibrated by injecting liquid standards in a Standard Delivery Mode (SDM) from Picarro. The 0.6 Hz-precision of the analyser on δ D is <13.5‰ at 500 ppmv H₂O and is <2‰ for 4000 ppmv. The absolute uncertainty for δ D is <13.7‰ at 500 ppmv and <2.3‰ at 4500 ppmv. The error estimation accounts for instrument precision as well as errors due to the applied data corrections (SDM effects + instrumental drifts <1‰, liquid standard bias <0.7‰, calibration bias <0.5‰) for δ D.

7.3 Summary of remarkable results during the period 2017-2018

The FTIR activities from 2017 to 2018 have been focused on ground and space-based remote sensing FTIR spectrometry as well as in-situ spectrometry.

7.3.1 Ground-based high-resolution FTIR spectrometry

The ground-based HR FTIR observations have a large potential for monitoring and investigating the composition of the troposphere, the stratosphere and their exchange processes. This is fundamental to monitor and study, for example, the sources and sinks of greenhouse gases or the evolution of the ozone layer. For this purpose, our activities have addressed the optimisation, development and validation of the new strategies for monitoring the long-term evolution of trace gases, such as greenhouse gases and ozone, in the framework of NDACC and TCCON networks (e.g., Sanromá et al., 2017a, 2017b; García et al., 2018a). Routinely, the IARC HR FTIR have contributed to NDACC with C₂H₆, ClONO₂, CO, CH₄, COF₂, HCl, HCN, HF, H₂CO, HNO₃, N₂O, NO₂, NO, O₃ and OCS observations (total column amounts and VMR vertical profiles) since 1999, while total column-averaged abundances of CO₂, N₂O, CH₄, HF, CO, H₂O and HDO are measured within TCCON since 2007 (see Fig. 7.3).

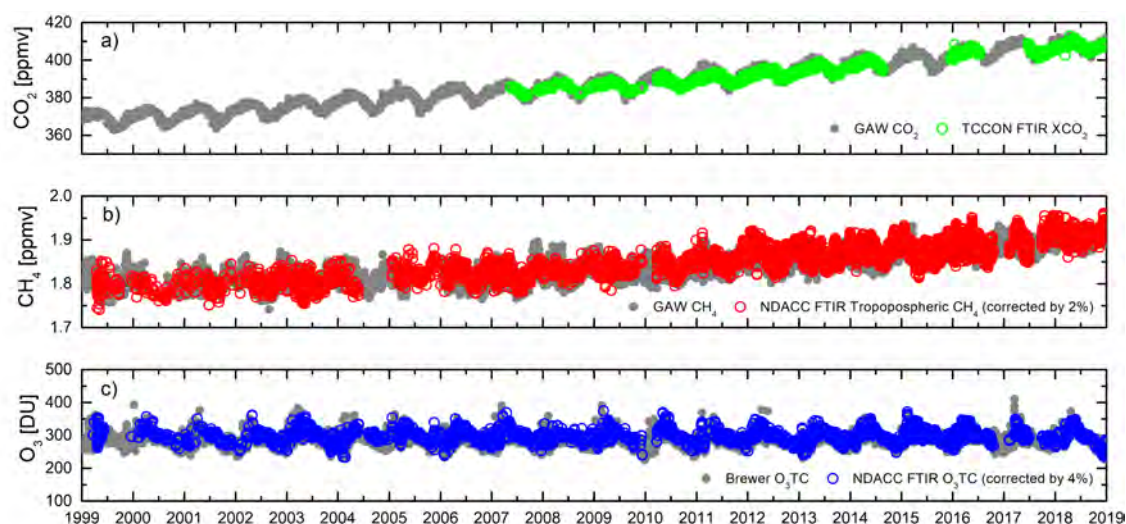

Figure 7.3. Time series of the total column-averaged abundances of a) carbon dioxide (XCO₂) in the framework of TCCON, b) tropospheric methane (CH₄) and c) ozone total column (O₃TC) amounts in the framework of NDACC as observed by the IARC FTIR. For comparison, the time series of these trace gases as observed by other high-quality measurement techniques available at the IARC are also displayed (GAW in-situ records for CO₂ and CH₄, and Brewer O₃TC amounts for O₃).

With these refined time series we have participated in numerous studies at a global scale. For example, the IARC HR FTIR station has been one of the 21 NDACC locations (Fig. 7.4) used to design and optimized a harmonized retrieval strategy to derive formaldehyde (H_2CO) total column amounts (Vigouroux et al., 2018). This unprecedented harmonized H_2CO data set covers very different concentration levels of formaldehyde, from very clean levels at the limit of detection (few 10^{13} molec cm^{-2}) to highly polluted levels (7×10^{16} molec cm^{-2}). These H_2CO time series, some of them starting in the 1990s, are crucial for past and present satellite validation and will be extended in the coming years for the next generation of satellite missions (Vigouroux et al., 2018).



Figure 7.4. Locations of the FTIR stations providing harmonized HCHO total columns (reprinted from Vigouroux et al., 2018).

In addition, we have investigated the long-term changes in different trace gases, such as ozone or methane across the globe (Bader et al., 2017; Steinbrecht et al., 2017; Gaudel et al., 2018). For example, Steinbrecht et al. (2017), analysing the ozone profile trends over the period 2000 to 2016 from several merged satellite ozone data sets and from ground-based data measured by four techniques at NDACC, found significant ozone increases in the upper stratosphere, between 35 and 48 km altitude (5 and 1 hPa, see Fig. 7.5).

Near 2 hPa (42 km), ozone has been increasing by about 1.5 % per decade in the tropics (20° S to 20° N), and by 2 to 2.5 % per decade in the 35 to 60° latitude bands of both hemispheres. At levels below 35 km (5 hPa), 2000 to 2016 ozone trends are smaller and not statistically significant. The observed trend profiles are consistent with expectations from chemistry climate model simulations and confirm positive trends of upper stratospheric ozone already reported in literature. Focused on the troposphere, the IARC HR FTIR ozone time series have also contributed to the first Tropospheric Ozone Assessment Report (www.igacproject.org/TOAR). This multidisciplinary project addresses different aspects of tropospheric ozone, from technical aspects such as the global ozone metrics to present-day ozone distribution and trends relevant to climate change, human health, vegetation, global atmospheric chemistry model evaluation, etc. (e.g., Gaudel et al., 2018).

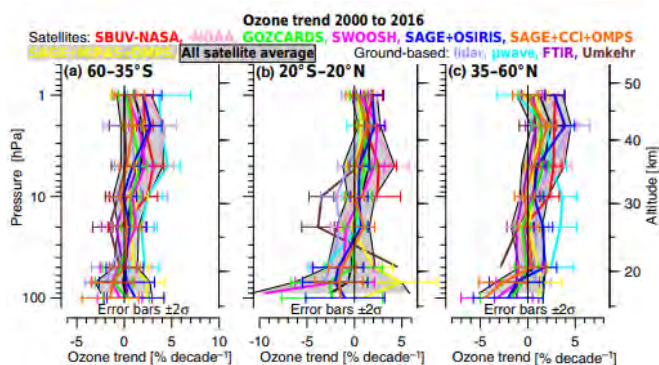

Figure 7.5. Vertical profiles of 2000 to 2016 ozone trends for different merged satellite and ground-based station data sets. Results are for the zonal bands 60 to 35° S (a), 20° S to 20° N (b) and 35 to 60° N (c) (reprinted from Steinbrecht et al., 2017). The HR FTIR data from IZO are included for the 35 to 60° N band.

Regarding methane, Bader et al. (2017) found that, combining FTIR and model estimations, natural sources such as wetlands and biomass burning contribute to the inter-annual variability of methane. However, anthropogenic emissions, such as coal mining, and gas and oil transport and exploration, which are mainly emitted in the Northern Hemisphere and act as secondary contributors to the global budget of methane, have played a major role in the increase of atmospheric methane observed since 2005.

7.3.2 Ground-based low-resolution FTIR spectrometry

The EM27/SUN spectrometer shares the same working philosophy as HR FTIR and, by covering the near infrared spectral range from 5000 to 11000 cm^{-1} with a spectral resolution of 0.5 cm^{-1} , it is able to measure total columns of O_2 , CO_2 , CH_4 , CO and H_2O (Frey et al., 2015, 2018 and references therein).

In the framework of the COCCON infrastructure, the performance of an ensemble of the 30 EM27/SUN spectrometers, including the IARC EM27/SUN, was recently tested and found to be very uniform (Frey et al., 2018). In addition, this work also confirms that the EM27/SUN is a very long-term stable instrument and provides very precise XCO_2 and XCH_4 observations by comparing to coincident TCCON HR FTIR spectrometers (Frey et al., 2018). As example, Fig. 7.6 displays the comparison of the coincident EM27/SUN and TCCON HR FTIR observations taken during the summer 2018 at IZO. Relative to the reference TCCON data, the EM27/SUN data sets are slightly biased low with scaling factor (EM27/SUN / TCCON) of 0.9980 (i.e., a bias of 0.8 ppmv) for XCO_2 and 0.9953 (i.e., a bias of 8.6 ppbv) for XCH_4 . However, the very low scatter found in the comparison documents the high performance of this low-resolution instrument (1σ of 0.0010 and 0.0009 for the scaling factors for XCO_2 and XCH_4 , respectively).

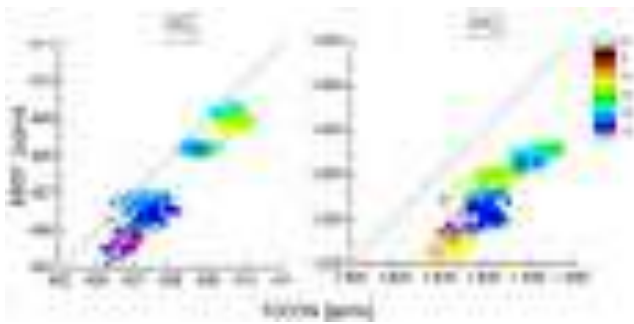

Figure 7.6 XCO₂ and XCH₄ comparison between EM27/SUN and TCCON observations at IZO (1-minute coincident pairs). The colorbar denotes the acquisition time of the measurements.

Therefore, this LR FTIR has shown to be a very promising instrument to monitor atmospheric greenhouse gases concentrations as it is mobile, reliable, easy to deploy, low-cost and precise spectrometer. It is a useful complement to the existing TCCON network in remote areas, but also for the quantification of local sinks/sources and flux emissions. With this idea, the IARC is leading the Spanish project MEGEI (MEdida de las concentraciones de Gases de Efecto Invernadero en ambientes urbanos, García et al., 2018d) to monitor the greenhouse gas concentrations (and then flux emissions) in urban environments by using these LR FTIR spectrometers. The first activity within MEGEI was the field campaign MEGEI-MAD carried out in Madrid (Spain) between 24th September and 7th October 2018 (see Fig. 7.7),

with the collaboration of the [IMK-ASF-KIT](#), University of Heidelberg, Universitat Autònoma de Barcelona (UAB), University of Valladolid, and Barcelona Supercomputer Center (BSC). MEGEI-MAD aims to measure the atmospheric concentrations of CO₂ and CH₄ in the total column by using five COCCON EM27/SUN around Madrid. These GEI observations were complemented by in situ mobile records around the M40 highway performed by in situ analysers mounted on a scientific car (UAB), and simulations from the HERMES v3.0 emission model (BSC). Figure 7.8 displays the time series of XCO₂, XCH₄, XCO and XH₂O observed during the MEGEI-MAD using the five COCCON EM27/SUN spectrometers



Figure 7.7. Calibration measurements performed during MEGEI-MAD on the top of the AEMET Headquarters in Madrid.

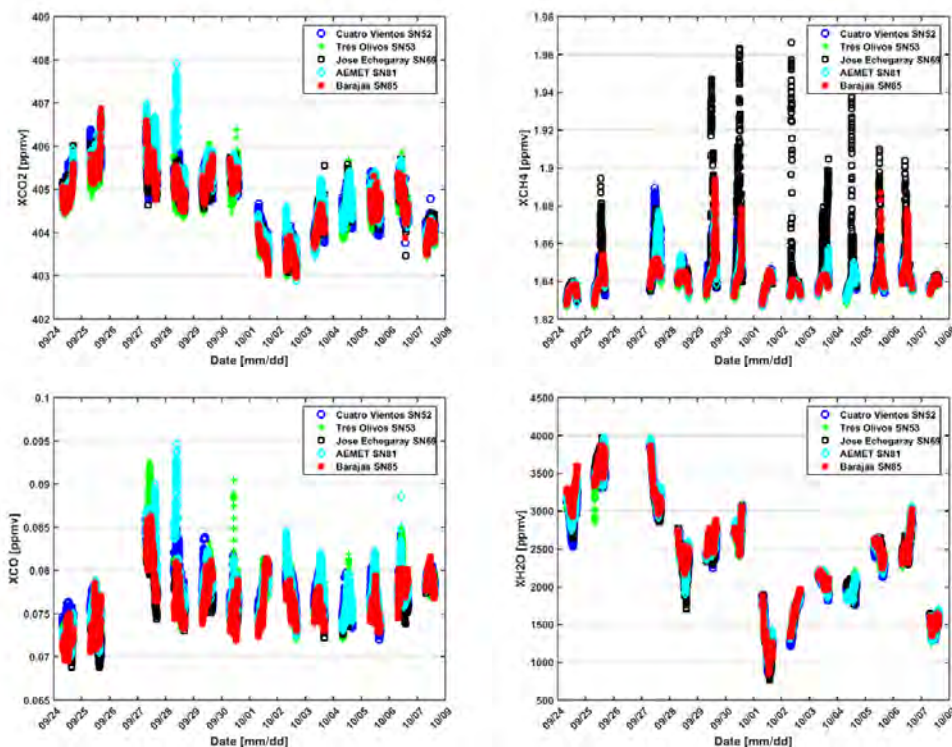

Figure 7.8. Time series of the total column-averaged abundances of carbon dioxide (XCO₂), methane (XCH₄), carbon monoxide (XCO) and water vapour (XH₂O) as observed by five COCCON EM27/SUN spectrometers during the scientific campaign MEGEI-MAD in Madrid between 24th September and 7th October 2018.

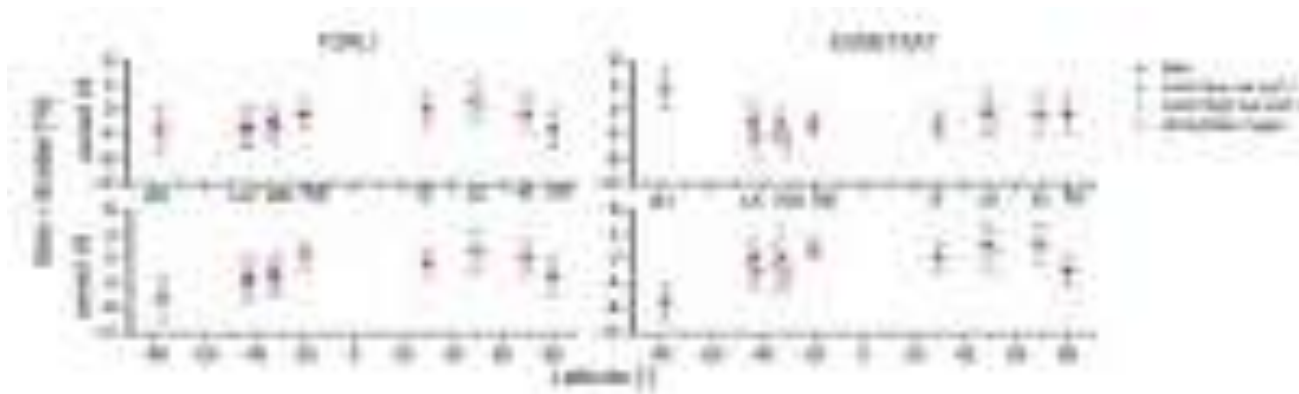

Figure 7.9. Example of the MUSICA/IASI-A VMR global maps for H₂O (upper left panel) at ~4.9 km for all individual IASI observations, and CH₄ (upper right panel), N₂O (bottom left panel), and CH₄ combined with N₂O (bottom right panel) at ~10 km for 2°x 2° averages on 16/08/2014. The H₂O global map is reprinted from Schneider et al. (2016), while the remaining maps are reprinted from García et al. (2016b).

7.3.3 Space-based FTIR spectrometry

The IARC's high quality HR FTIR data have been extensively applied for many years for the validation of trace gases measured by different satellite instruments (ILAS, MIPAS, ACE-FTS, GOME,...). During the period 2017-2018, particularly, we have participated in the validation of CO, NO₂ and CO₂ observations from space-based remote platforms like the TROPOMI, SCIAMACHY, MIPAS and OCO-II (Yela et al., 2017; Wunch et al., 2017; Borsdorff et al., 2018a, 2018b, O'Dell et al., 2018).

Within space-based FTIR spectrometry, our activities are mainly focused on the Infrared Atmospheric Sounding Interferometer (IASI) on board MetOp/EUMETSAT satellites through the European projects MUSICA (Multiplatform remote Sensing of Isotopologues for investigating the Cycle of Atmospheric water) and VALIASI (Validation of the operational EUMETSAT IASI trace gas products), the Spanish project INMENSE (IASI for surveying methane and nitrous oxide in the troposphere) and the German project MOTIV (MOisture Transport pathways and Isotopologues in water Vapour).

VALIASI

By means of VALIASI the long-term validation of the IASI operational trace gas products (O₃, CO, CO₂, CH₄ and N₂O) for different IASI processors is being carried out (García et al., 2017; Sepúlveda et al., 2017a, 2017b). Special attention has been paid to the quality assessment of the IASI ozone products (total column amounts and vertical profiles) on a global scale. An example of the IASI-FTIR comparison at different NDACC FTIR stations is displayed in Figure 7.9. For the IASI observations two retrieval codes are considered: the EUMETSAT IASI level 2 (L2) generated by the EPS Core Ground Segment (version 5 and version 6) and the FORLI (Fast Optimal Retrievals on Layers for IASI) from LATMOS (Laboratoire Atmosphères Milieux Observations Spatiales).

MUSICA and MOTIV

In addition to ozone and greenhouse gases, one key element in the Earth's climate is the water cycle. Remote sensing observations of water vapour isotopologue composition can give novel opportunities for understanding the different water cycle processes and their link to the climate. However, their observation, when using remote sensing techniques, is challenging. The project MUSICA addresses this task by consistently developing ground and space-based remote sensing retrievals and integrating them with well-calibrated in-situ measurements. In the context of MUSICA, it has extensively shown that NDACC/FTIR and MetOp/IASI retrievals of {H₂O, δD}-pairs are in principle feasible and consistent with well-calibrated in-situ observations, and a very useful tool to investigate the lower/middle tropospheric moisture pathways. Numerous publications document the important advances carried out in observing tropospheric isotopologues during this project (e.g., Schneider et al., 2016; Barthlott et al., 2017; Christner et al., 2017; Schneider et al., 2017; Borger et al., 2018, see <http://www.imk-asf.kit.edu/english/915.php> for details).

The great potential of the different MUSICA products makes them a very useful tool in water vapour cycle research. This is the idea of the German project MOTIV, which combines the high-resolution MUSICA IASI isotopologue observations with high-resolution modelling, with the final objective of using the isotopologues as a diagnostic tool to investigate moisture pathways and evaluate the representation of moist processes in weather and climate models. The combination of simulations and MUSICA products allow statistically robust investigations, which give insight into the diurnal cycle, small-scale variations and effects of large-scale circulations of moisture in the atmosphere. Within MOTIV, the space-based isotopologue observations are complemented with the in-situ continuous measurements recorded at IZO and PTO since 2012.

INMENSE

The Spanish project INMENSE aims to improve our current understanding of the atmospheric budgets of two of the most important greenhouse gases, CH₄ and N₂O. Knowledge of the atmospheric CH₄ and N₂O distributions, from local to global scales, as well as their variability in time is essential for a better understanding of their sinks and sources, and for predicting their evolution in the atmosphere. In order to achieve this core objective, INMENSE will generate a new global observational data set of middle/upper tropospheric concentrations of CH₄ and N₂O with high and well-documented quality by using the IASI processor developed during the project MUSICA. By integrating IASI observations and model estimates, INMENSE will investigate the kind of CH₄ and N₂O sink/source signals that can be captured by high-quality IASI observations. An example of the global distribution of the MUSICA/INMENSE CH₄ concentrations in the free troposphere is shown in Figure 7.10.

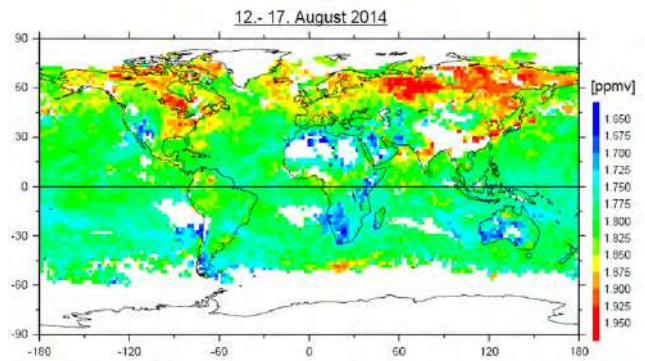

Figure 7.10. MUSICA/INMENSE IASI CH₄ concentrations at 4.2 km altitude for mid-August 2014 averaged for a latitude×longitude area of 2°×2°. Reprinted from García et al., (2018).

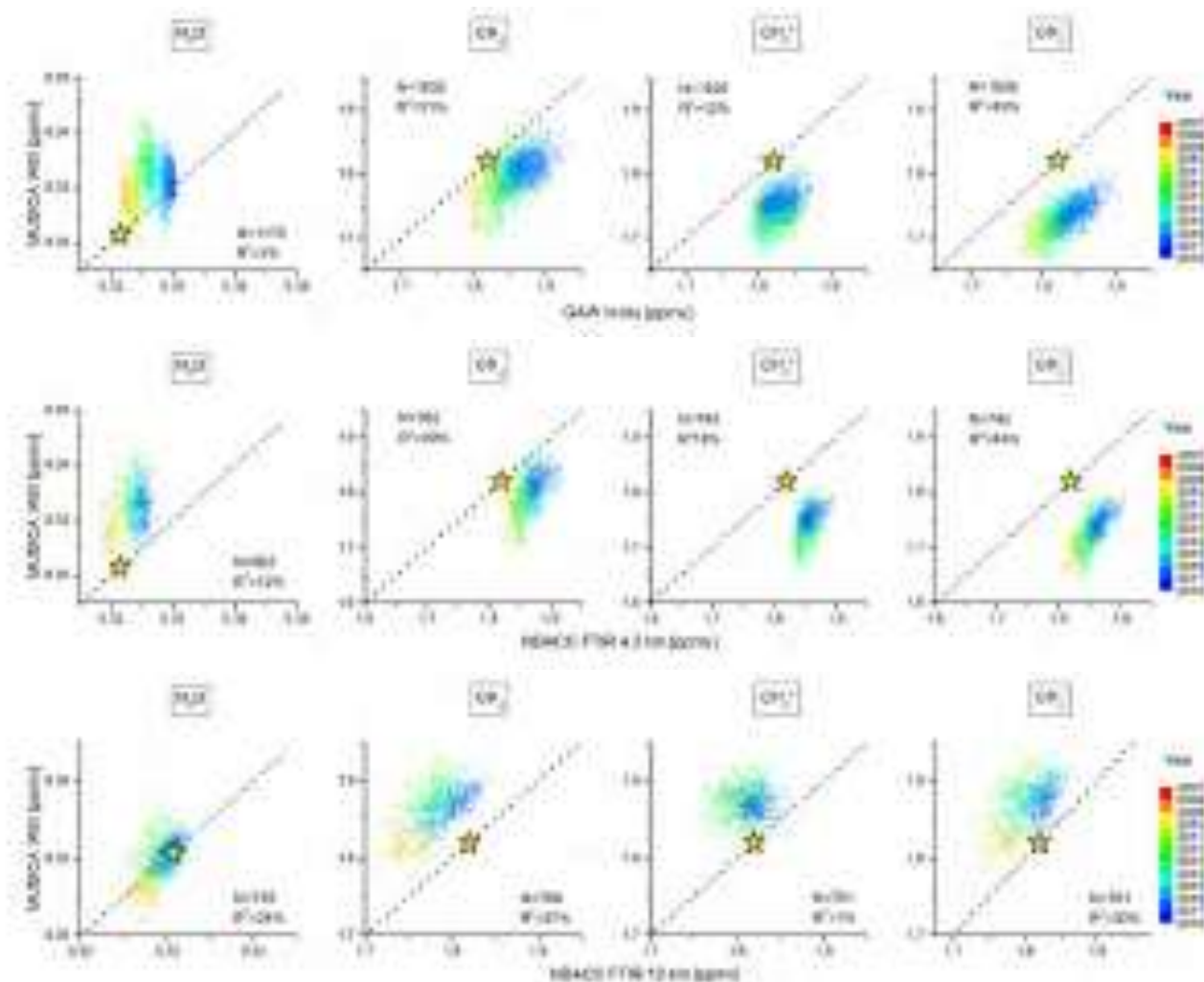

Figure 7.11. Correlation plots between daily night mean MUSICA IASI 4.2 km retrieval products and GAW in situ data (first row), and between daily mean MUSICA IASI retrieval products and NDACC FTIR products at 4.2 km (second row) and 12 km (third row) at IZO. The colour code indicates the year of observation, the yellow star represents the a priori data used for the retrievals and the black dashed line is the one-to-one diagonal. Number of considered days (N) and R² values are given in each panel (all correlations are positive and significant on the 95 % confidence level). A detailed description of the post-corrected CH₄^{*} and CH₄' products is given in García et al. (2018). Reprinted from García et al. (2018).

For a correct scientific interpretation of the new IASI observational records, it is essential to comprehensively evaluate these observations in order to ensure the correct capture of the CH₄ and N₂O concentration variations on different spatial and temporal scales. This has been done by García et al., (2018). This work, firstly, describes the characteristics and errors of the new IASI products. Secondly, the products are comprehensively evaluated by comparisons to the following reference data measured by different techniques and from different platforms as follows: (1) aircraft CH₄ and N₂O profiles from the five HIAPER Pole-to-Pole Observation (HIPPO) missions; (2) continuous in situ CH₄ and N₂O observations performed between 2007 and 2017 at subtropical and mid-latitude high-mountain observatories (IZO and Jungfraujoch, respectively) in the framework of the WMO GAW programme; (3) ground-based FTIR measurements made between 2007 and 2017 in the framework of the NDACC at the subtropical IZO, the mid-latitude station of Karlsruhe and the Kiruna polar site. Figure 7.11 shows an example of these multi-platform comparisons at IZO.

The theoretical estimations and the comparison studies suggest a precision for the N₂O and CH₄ retrieval products of about 1.5–3 % and systematic errors due to spectroscopic parameters of about 2 %. The MUSICA IASI CH₄ data offer a better sensitivity than N₂O data. While for the latter, the sensitivity is mainly limited to the upper troposphere – lower stratosphere (UTLS) region, for CH₄ we are able to prove that at low latitudes the MUSICA IASI processor can detect variations that take place in the free troposphere independently from the variations in the UTLS region. We demonstrate that the MUSICA IASI data qualitatively capture the CH₄ gradients between low and high latitudes and between the Southern Hemisphere and Northern Hemisphere; however, we also find an inconsistency between low- and high-latitude CH₄ data of up to 5%. The N₂O latitudinal gradients are very weak and cannot be detected. We make comparisons over a 10-year time period and analyse the agreement with the reference data on different timescales. The MUSICA IASI data can detect day-to-day signals (only in the UTLS), seasonal cycles and long-term evolution (in the UTLS and for CH₄ also in the free troposphere) similar to the reference data; however, there are also inconsistencies in the long-term evolution connected to inconsistencies in the used atmospheric temperature a priori data.

Moreover, we present a method for analytically describing the a posteriori-calculated logarithmic-scale difference of the CH₄ and N₂O retrieval estimates. By correcting errors that are common in the CH₄ and N₂O retrieval products, the a posteriori-calculated difference can be used for generating an a posteriori-corrected CH₄ product with a theoretically better precision than the original CH₄ retrieval products. We discuss and evaluate two different approaches for such a posteriori corrections (CH₄* and CH₄' products). It is shown

that the correction removes the inconsistencies between low and high latitudes and enables the detection of day-to-day signals also in the free troposphere. Furthermore, they reduce the impact of short-term atmospheric dynamics, which is an advantage, because respective signals are presumably hardly comparable to model data. The approach that affects the correction solely on the scales on which the errors dominate (CH₄') is identified as the most efficient, because it reduces the inconsistencies and errors without removing measurable real atmospheric signals.

7.4 Participation in Scientific Campaigns and Research Stays

7.4.1 ATOM

Within the Atmospheric Tomography Mission (ATom), the three remaining campaigns of the project were carried out in January-February 2017 (ATom-2), September-October 2017 (ATom-3) and April-May 2018 (ATom-4). ATom studies the impact of human-produced air pollution on greenhouse gases and on chemically reactive gases in the atmosphere. For this purpose, ATom deploys an extensive gas and aerosol payload on the NASA DC-8 aircraft for systematic, global-scale sampling of the atmosphere, profiling continuously from 0.2 to 12 km altitude. Flights originate from the Armstrong Flight Research Center in Palmdale, California, fly north to the western Arctic, south to the South Pacific, east to the Atlantic, north to Greenland, and return to California across central North America. During the transects over the Atlantic Ocean, IARC HR FTIR was measuring in coincidence with the ATom DC-8 aircraft.

7.4.2 CINECA

Within the project INMENSE and in the framework of the HPC-Europa3 Transnational Access programme, an IARC researcher enjoyed a scientific research stay at the CINECA High Performance Computing centre in Bologna (Italy) in the summer 2018. The objective of this stay was to exploit the HPC resources to generate a “pseudo” climatology of the CH₄ and N₂O concentrations at a global scale as observed by space-based IASI sensors.

7.5 References

- Bader, W., Bovy, B., Conway, S., Strong, K., Smale, D., Turner, A. J., Blumenstock, T., Boone, C., Coulon, A., Garcia, O., Griffith, D. W. T., Hase, F., Hausmann, P., Jones, N., Krummel, P., Murata, S. I., Morino, I., Nakajima, H., O'Doherty, S., Paton-Walsh, C., Robinson, J., Sandrin, R., Schneider, M., Servais, C., Sussmann, R., and Mahieu, E.: The recent increase of atmospheric methane from 10 years of ground-based NDACC FTIR observations since 2005, *Atmos. Chem. Phys.*, 17, 2255-2277, doi:10.5194/acp-17-2255-2017, 2017.
- Barthlott, S., Schneider, M., Hase, F., Blumenstock, T., Kiel, M., Dubravica, D., Garcia, O. E., Sepúlveda, E., Mengistu Tsidu, G., Takele Kenea, S., Grutter, M., Plaza-Medina, E. F., Stremme, W., Strong, K., Weaver, D., Palm, M., Warneke, T.,

- Notholt, J., Mahieu, E., Servais, C., Jones, N., Griffith, D. W. T., Smale, D., and Robinson, J.: Tropospheric water vapour isotopologue data (H216O, H218O, and HD16O) as obtained from NDACC/FTIR solar absorption spectra, *Earth Syst. Sci. Data*, 9, 15-29, doi:10.5194/essd-9-15-2017, 2017.
- Borger, C., Schneider, M., Ertl, B., Hase, F., García, O. E., Sommer, M., Höpfner, M., Tjemkes, S. A., and Calbet, X.: Evaluation of MUSICA IASI tropospheric water vapour profiles using theoretical error assessments and comparisons to GRUAN Vaisala RS92 measurements, *Atmos. Meas. Tech.*, 11, 4981-5006, https://doi.org/10.5194/amt-11-4981-2018, 2018.
- Borsdorff, T., aan de Brugh, J., Hu, H., Hasekamp, O., Sussmann, R., Rettinger, M., Hase, F., Gross, J., Schneider, M., García, O., Stremme, W., Grutter, M., Feist, D. G., Arnold, S. G., De Mazière, M., Kumar Sha, M., Pollard, D. F., Kiel, M., Roehl, C., Wennberg, P. O., Toon, G. C., and Landgraf, J.: Mapping carbon monoxide pollution from space down to city scales with daily global coverage, *Atmos. Meas. Tech.*, 11, 5507-5518, https://doi.org/10.5194/amt-11-5507-2018, 2018.
- Borsdorff, T., J. aan de Brugh, H. Hu, O. Hasekamp, R. Sussmann, M. Rettinger, F. Hase, J. Gross, M. Schneider, O.E. Garcia, W. Stremme, M. Grutter, D. G. Feist, M. De Maziere, M. Kumar Sha, D.F. Pollard, M. Kiel, G.C. Toon, P.O. Wennberg, and J. Landgraf, First carbon monoxide retrieval from TROPOMI's shortwave infrared radiance measurements, European Geosciences Union General Assembly 2018, Vienna (Austria), 8-13 April, 2018.
- Frey, M., Sha, M. K., Hase, F., Kiel, M., Blumenstock, T., Harig, R., Surawicz, G., Deutscher, N. M., Shiomi, K., Franklin, J., Bösch, H., Chen, J., Grutter, M., Ohyama, H., Sun, Y., Butz, A., Mengistu Tsidu, G., Ene, D., Wunch, D., Cao, Z., Garcia, O., Ramonet, M., Vogel, F., and Orphal, J.: Building the COllaborative Carbon Column Observing Network (COCCON): Long term stability and ensemble performance of the EM27/SUN Fourier transform spectrometer, *Atmos. Meas. Tech. Discuss.*, https://doi.org/10.5194/amt-2018-146, in review, 2018.
- García, O. E., Schneider, M., Redondas, A., González, Y., Hase, F., Blumenstock, T., and Sepúlveda, E.: Investigating the long-term evolution of subtropical ozone profiles applying ground-based FTIR spectrometry, *Atmos. Meas. Tech.*, 5, 2917-2931, doi:10.5194/amt-5-2917-2012, 2012.
- García, O.E., E. Sepúlveda, M. Schneider, A. Wiegeler, C. Borger, F. Hase, E. Sanromá, Á.-J. Gómez-Peláez, A. Cansado, M. Aullé, and S. Barthlott, INMENSE: IASI for Surveying Methane and Nitrous Oxide in the Troposphere, EUMETSAT Meteorological Satellite Conference, Roma, 2-6 Octubre, 2017.
- García, O.E., E. Sepúlveda, E. Cuevas, A.J. Gómez-Peláez, M. Schneider, F. Hase, T. Blumenstock, A. Redondas, and V. Carreño, Long-term Monitoring of Greenhouse Gases at the Izaña Atmospheric Observatory, 14th International Workshop on Greenhouse Gas Measurements from Space (IWGGMS-14), Toronto (Canada), 8-10 May, 2018a.
- García, O.E., M. Schneider, B. Ertl, F. Hase, C. Borger, E. Sepúlveda, T. Blumenstock, Uwe Raffälski and A.J. Gómez-Peláez, IASI for Surveying Methane and Nitrous Oxide in the Troposphere: MUSICA products and its validation, 14th International Workshop on Greenhouse Gas Measurements from Space (IWGGMS-14), Toronto (Canada), 8-10 May, 2018b.
- García, O. E., Schneider, M., Ertl, B., Sepúlveda, E., Borger, C., Diekmann, C., Wiegeler, A., Hase, F., Barthlott, S., Blumenstock, T., Raffälski, U., Gómez-Peláez, A., Steinbacher, M., Ries, L., and de Frutos, A. M.: The MUSICA IASI CH₄ and N₂O products and their comparison to HIPPO, GAW and NDACC FTIR references, *Atmos. Meas. Tech.*, 11, 4171-4215, https://doi.org/10.5194/amt-11-4171-2018, 2018c.
- García, O.E., Sepúlveda, E., J.-A. Morgui, C. Estruch, R. Curcoll, M. Frey, C. Schneider, R. Ramos, C. Torres, S. León, F. Hase, A. Butz, C. Toledano, E. Cuevas, T. Blumenstock, C. Pérez, M. Guevara, J. J. Bustos, and V. Carreño, MEGEI-MAD: Monitoring of Greenhouse Gases Concentrations in Madrid, Integrated Global Greenhouse Gas Information System (IG3IS) Symposium, 13 – 15 November, WMO, Geneva, Switzerland, 2018d
- Gaudel, A., O. R. Cooper, G. Ancellet, B. Barret, A. Boynard, J. P. Burrows, C. Clerbaux, P.-F. Coheur, J. Cuesta, E. Cuevas, S. Doniki, G. Dufour, F. Ebojje, G. Foret, O. Garcia, M. J. Granados-Muñoz, J. W. Hannigan, F. Hase, B. Hassler, G. Huang, D. Hurtmans, D. Jaffe, N. Jones, P. Kalabokas, B. Kerridge, S. Kulawik, B. Latter, T. Leblanc, E. Le Flochmoën, W. Lin, J. Liu, X. Liu, E. Mahieu, A. McClure-Begley, J. L. Neu, M. Osman, M. Palm, H. Petetin, I. Petropavlovskikh, R. Quere, N. Rapp, A. Rozanov, M. G. Schultz, J. Schwab, R. Siddans, D. Smale, M. Steinbacher, H. Tanimoto, D. W. Tarasick, V. Thouret, A. M. Thompson, T. Trickl, E. Weatherhead, C. Wespes, H. M. Worden, C. Vigouroux, X. Xu, G. Zeng, J. Ziemke: The Tropospheric Ozone Assessment Report: Present-day distribution and trends of tropospheric ozone relevant to climate and global atmospheric chemistry model evaluation, *Elem Sci Anth*, 6: 39. DOI: https://doi.org/10.1525/elementa.291, 2018.
- Gisi, M., F. Hase, S. Dohe, and T. Blumenstock: Camtracker: a new camera controlled high precision solar tracker system for FTIR-spectrometers, *Atmos. Meas. Tech.*, 4, 47-54, 2011.
- Hase, F., T. Blumenstock, C. Paton-Walsh: Analysis of the instrumental line shape of high-resolution Fourier transform IR spectrometers with gas cell measurements and new retrieval software, *Appl. Opt.* 38, 3417-3422, 1999.
- Hase, F., J.W. Hannigan, M.T. Coffey, A. Goldman, M. Höpfner, N.B. Jones, C.P. Rinsland, S.W. Wood: Intercomparison of retrieval codes used for the analysis of high-resolution, ground-based FTIR measurements, *Journal of Quantitative Spectroscopy & Radiative Transfer* 87, 25–52, 2004.
- Hase, F., M. Frey, D. Dubravica, J. Groß, T. Blumenstock, Q. Tu, J. Orphal, A. Dehn, P. Castracane, A. Butz, R. Kleinschek, A. Luther, J. Chen, R. Harig, G. Surawicz, W.R. Simpson, N. Jacobs, M. Grutter, W. Stremme, N. Jones, D. W. Griffith, G. Mengistu Tsidu, K. Shiomi, I. Morino, S. Wofsy, O. Garcia, D. Pollard, M. Dubey, D. Wunch, P.O. Wennberg, M.K. Sha, H. Gadhavi, D. Ene, M. Ramonet, Y. Sun, and H. Boesch, COCCON - a framework for operating the EM27/SUN spectrometer, 2nd Sentinel-5P Validation Team Meeting and 1st Results Workshop, Noordwijk (Netherlands), 5-6 February, 2018.
- Kulawik, S.S., C. O'Dell, G. Osterman, P. Wennberg, D. Wunch, C. Roehl, N. Deutscher, M. Kiel, D. Griffith, V. Velasco, J. Notholt, T. Warneke, C. Petri, M. De Maziere, M. Kumar Sha, R. Sussmann, M. Rettinger, D. Pollard, I. Morino, O. Uchino, F. Hase, D. Feist, K. Strong, R. Kivi, L. Iraci, K. Shuji, M. Dubey, E. Sepulveda, O.E. Garcia, Y. Te, P. Jeseck, M. Kiel, P. Heikkinen, M. Schneider, S. Wofsy, K. McKain, C. Sweeney, D. Baker, and J. Liu, Characterization of OCO-2 biases and errors for flux estimates, 14th International Workshop on Greenhouse Gas Measurements from Space (IWGGMS-14), Toronto (Canada), 8-10 May, 2018.
- O'Dell, C. W., Eldering, A., Wennberg, P. O., Crisp, D., Gunson, M. R., Fisher, B., Frankenberg, C., Kiel, M., Lindqvist, H.,

- Mandrake, L., Merrelli, A., Natraj, V., Nelson, R. R., Osterman, G. B., Payne, V. H., Taylor, T. E., Wunch, D., Drouin, B. J., Oyafuso, F., Chang, A., McDuffie, J., Smyth, M., Baker, D. F., Basu, S., Chevallier, F., Crowell, S. M. R., Feng, L., Palmer, P. I., Dubey, M., García, O. E., Griffith, D. W. T., Hase, F., Iraci, L. T., Kivi, R., Morino, I., Notholt, J., Ohyama, H., Petri, C., Roehl, C. M., Sha, M. K., Strong, K., Sussmann, R., Te, Y., Uchino, O., and Velazco, V. A.: Improved retrievals of carbon dioxide from Orbiting Carbon Observatory-2 with the version 8 ACOS algorithm, *Atmos. Meas. Tech.*, 11, 6539-6576, <https://doi.org/10.5194/amt-11-6539-2018>, 2018.
- Sanromá, E., O.E. García, F. Hase, M. Schneider, T. Blumenstock, E. Sepúlveda, A. Redondas, M. Navarro-Comas, and V. Carreño, Improved Retrieval Strategy for Ozone Monitoring by Ground-Based FTIR Spectrometry, NDACC/IRWG and TCCON Meeting, Paris (France), 29 May-02 June, 2017a.
- Sanromá, E., O.E. García, M. Schneider, F. Hase, T. Blumenstock, and E. Sepúlveda, Ozone Isotopologue Monitoring from Ground-Based FTIR Spectrometry, NDACC/IRWG and TCCON Meeting, Paris (France), 29 May-02 June, 2017b.
- Schneider, M., A. Redondas, F. Hase, C. Guirado, T. Blumenstock, and E. Cuevas: Comparison of ground-based Brewer and FTIR total O₃ monitoring techniques, *Atmos. Chem. Phys.*, 8, 5535-5550, 2008.
- Schneider, M., P. M. Romero, F. Hase, T. Blumenstock, E. Cuevas, and R. Ramos: Continuous quality assessment of atmospheric water vapour measurement techniques: FTIR, Cimel, MFRSR, GPS, and Vaisala RS92, *Atmos. Meas. Tech.*, 3, 323-338, 2010.
- Schneider, M., Wiegele, A., Barthlott, S., González, Y., Christner, E., Dyroff, C., García, O. E., Hase, F., Blumenstock, T., Sepúlveda, E., Mengistu Tsidu, G., Takele Kenea, S., Rodríguez, S., and Andrey, J.: Accomplishments of the MUSICA project to provide accurate, long-term, global and high-resolution observations of tropospheric {H₂O,δD} pairs – a review, *Atmos. Meas. Tech.*, 9, 2845-2875, doi:10.5194/amt-9-2845-2016, 2016.
- Schneider, M., Borger, C., Wiegele, A., Hase, F., García, O. E., Sepúlveda, E., and Werner, M.: MUSICA MetOp/IASI {H₂O,δD} pair retrieval simulations for validating tropospheric moisture pathways in atmospheric models, *Atmos. Meas. Tech.*, 10, 507-525, doi:10.5194/amt-10-507-2017, 2017.
- Sepúlveda, E., Schneider, M., Hase, F., García, O. E., Gomez-Pelaez, A., Dohe, S., Blumenstock, T., and Guerra, J. C.: Long-term validation of total and tropospheric column-averaged CH₄ mole fractions obtained by mid-infrared ground-based FTIR spectrometry, *Atmos. Meas. Tech.*, 5, 1425-1441, doi:10.5194/amt-5-1425-2012, 2012.
- Sepúlveda, E., O.E. García, M. Schneider, T. August, C. Clerbaux, F. Hase, T. Blumenstock, T. Hultberg, E. Sanromá, V. Carreño, E. Mahieu, M. De Mazière, C. Vigouroux, D. Griffith, N. Jones, D. Smale, J. Notholt, M. Palm, and A. M. De Frutos, Ozone total and partial column amounts comparison between satellite-based MetOp-IASI and ground-based NDACC FTIR, NDACC/IRWG and TCCON Meeting, Paris (France), 29 May-02 June, 2017a.
- Sepúlveda, E., O.E. García, M. Schneider, T. August, T. Hultberg, C. Clerbaux, J. Hadji-Lazarou, P.-F. Coheur, D. Hurtmans, F. Hase, T. Blumenstock, E. Sanromá, V. Carreño, E. Mahieu, M. De Mazière, C. Vigouroux, D. Griffith, N. Jones, D. Smale, J. Notholt, M. Palm, A. M. De Frutos, Ozone Monitoring Comparison as observed by the satellite-based METOP-IASI and ground-based NDACC FTS, EUMETSAT Meteorological Satellite Conference, Roma, 2-6 Octubre, 2017b.
- Steinbrecht, W., Froidevaux, L., Fuller, R., Wang, R., Anderson, J., Roth, C., Bourassa, A., Degenstein, D., Damadeo, R., Zawodny, J., Frith, S., McPeters, R., Bhartia, P., Wild, J., Long, C., Davis, S., Rosenlof, K., Sofieva, V., Walker, K., Rahpoe, N., Rozanov, A., Weber, M., Laeng, A., von Clarmann, T., Stiller, G., Kramarova, N., Godin-Beekmann, S., Leblanc, T., Querel, R., Swart, D., Boyd, I., Hocke, K., Kämpfer, N., Maillard Barras, E., Moreira, L., Nedoluha, G., Vigouroux, C., Blumenstock, T., Schneider, M., García, O., Jones, N., Mahieu, E., Smale, D., Kotkamp, M., Robinson, J., Petropavlovskikh, I., Harris, N., Hassler, B., Hubert, D., and Tummon, F.: An update on ozone profile trends for the period 2000 to 2016, *Atmos. Chem. Phys.*, 17, 10675-10690, <https://doi.org/10.5194/acp-17-10675-2017>, 2017.
- Vigouroux, C., Bauer Aquino, C. A., Bauwens, M., Becker, C., Blumenstock, T., De Mazière, M., García, O., Grutter, M., Guarín, C., Hannigan, J., Hase, F., Jones, N., Kivi, R., Koshelev, D., Langerock, B., Lutsch, E., Makarova, M., Metzger, J.-M., Müller, J.-F., Notholt, J., Ortega, I., Palm, M., Paton-Walsh, C., Poberovskii, A., Rettinger, M., Robinson, J., Smale, D., Stavrakou, T., Stremme, W., Strong, K., Sussmann, R., Té, Y., and Toon, G.: DACC harmonized formaldehyde time-series from 21 FTIR stations covering a wide range of column abundances, *Atmos. Meas. Tech.*, 11, 5049-5073, <https://doi.org/10.5194/amt-11-5049-2018>, 2018.
- Wunch, D., Wennberg, P. O., Osterman, G., Fisher, B., Naylor, B., Roehl, C. M., O'Dell, C., Mandrake, L., Viatte, C., Griffith, D. W., Deutscher, N. M., Velazco, V. A., Notholt, J., Warneke, T., Petri, C., De Mazière, M., Sha, M. K., Sussmann, R., Rettinger, M., Pollard, D., Robinson, J., Morino, I., Uchino, O., Hase, F., Blumenstock, T., Kiel, M., Feist, D. G., Arnold, S. G., Strong, K., Mendonca, J., Kivi, R., Heikkinen, P., Iraci, L., Podolske, J., Hillyard, P. W., Kawakami, S., Dubey, M. K., Parker, H. A., Sepúlveda, E., García, O., Te, Y., Jeseck, P., Gunson, M. R., Crisp, D., and Eldering, A.: Comparisons of the Orbiting Carbon Observatory-2 (OCO-2) XCO₂ measurements with TCCON, *Atmos. Meas. Tech.*, 10, 2209-2238, doi:10.5194/amt-10-2209-2017, 2017.
- Yela, M., Gil-Ojeda, M., Navarro-Comas, M., González-Bartolomé, D., Puertedura, O., Funke, B., Iglesias, J., Rodríguez, S., García, O., Ochoa, H., and Deferrari, G.: Hemispheric asymmetry in stratospheric NO₂ trends, *Atmos. Chem. Phys.*, 17, 13373-13389, <https://doi.org/10.5194/acp-17-13373-2017>, 2017.

7.6 Staff and collaborators

The FTIR research group (listed below) is composed of researchers and specialist technicians from the IARC-AEMET, from IMK-ASF-KIT, and from GOA-UVA:

- Dr Omaira García (AEMET; Head of programme)
- Dr Eliezer Sepúlveda (AEMET; Research Scientist)
- Dr Esther Sanromá (AEMET; Research Scientist) left IARC in November 2017
- Ramón Ramos (AEMET; Head of Infrastructure)
- Dr Matthias Schneider (IMK-ASF-KIT; Head of the MUSICA group)
- Dr Thomas Blumenstock (IMK-ASF-KIT; Head of Ground-based remote-sensing using Fourier-transform interferometers (BOD) group)
- Dr Frank Hase (IMK-ASF-KIT; Research Scientist)
- Dr Matthias Frey (IMK-ASF-KIT; Research Scientist)

8 In situ Aerosols

8.1 Main Scientific Goals

Atmospheric aerosol is constituted by a mixing of natural (e.g. sea salt, desert dust or biogenic material) and anthropogenic (e.g. soot, industrial sulphate, nitrate, metals or combustion linked carbonaceous matter) airborne particles whose size range from a few nanometres (nm) to tens of microns (μm). Aerosols impair air quality with impacts on human health due to cardiovascular, cerebrovascular and respiratory diseases such as asthma and chronic obstructive pulmonary disease; they also influence climate by scattering and absorbing radiation and by influencing cloud formation and rainfall.

The activities of the In situ Aerosols programme are developed within the scientific priorities of the Global Atmosphere Watch programme. One of the main tasks of our group is to maintain the long-term observations of aerosols at IZO. These measurements improve the understanding of the potential long-term multi-decadal changes and trends of aerosols. Our investigations are focused on: 1) Long-term multi-decadal variability and trends of aerosols; 2) Aerosols and climate and 3) Aerosols and air quality.

8.2 Measurement Programme

The long-term in situ aerosols observation program of Izaña Atmospheric Observatory includes measurements of aerosol mass and number concentrations, chemical composition, size distribution and optical properties by in-situ techniques. Instruments are placed in the so-called Aerosols Research Laboratory (ARL) renamed as the Joseph M. Prospero Aerosols Research Laboratory, as a tribute to the pioneer of dust research, in 2016 (Fig. 8.1). The laboratory is equipped with a whole air inlet for conducting the aerosol sample to the on-line analysers (CPCs, SMPS, APS, MAAP, aethalometer, nephelometer), two additional PM_{10} and $\text{PM}_{2.5}$ inlets for the aerosol filter samplers and also two additional inlets for TEOM (PM_{10} and $\text{PM}_{2.5}$) and BETA (PM_{10}) analysers respectively. The interior of the Aerosols Research Laboratory is maintained at 22 °C. Because of the low relative humidity (RH) in the outdoor ambient air (RH percentiles 25th, 50th and 75th are 15%, 31% and 55%, respectively) driers are not needed. Measurements of number concentration, size distributions and optical properties of aerosols are performed with high time resolution (Table 3.2).

For these automatic instruments, the QA/QC activities include:

- <daily checks> of the data and status of the instruments.
- <weekly checks> of the airflows and leak tests for some instruments (e.g. SMPS).



Figure 8.1. Joseph M. Prospero Aerosols Research Laboratory at Izaña Atmospheric Observatory (upper panel: building; lower panel: part of the instrumentation inside).

- <quarterly checks> includes measurements of the instrumental zero (24h filtered air) for all the instruments (CPCs, SMPS, APS, MAAP, aethalometer nephelometer) and calibration checks (e.g. nephelometer).
- <annual intercomparisons> for some instruments.
- participation in intercomparisons, e.g. those performed annually between 2010 and 2012 for CPCs and SPMS at El Arenosillo - Huelva (Gómez-Moreno et al., 2011, 2013) and those in the World Calibration Centre for Aerosols Physics (WCCAP) in Leipzig – Germany for CPCs (Sep 2012) and absorption photometers (Nov 2005; Müller et al., 2011).

The procedure for these activities follows the recommendation of the GAW programme for aerosols.

In October 2017, the instruments of the ARL (SMPS, CPCs, MAAPs, nephelometers and aethalometer) were recalibrated at the WCCAP in Germany (Fig. 8.2). All

devices obtained the calibration certificate. These procedures allow the long-term aerosol records at IZO to be traced to the international reference standards.



Figure 8.2. CPCs of Izaña during the calibration activities at the WCCAP in October 2017.

The aerosols chemical composition programme is based on:

- the collection of aerosol samples on filters. Samples are collected at night to avoid the diurnal upslope winds that may bring material from the boundary layer,
- the determination of the aerosol mass concentrations by the gravimetric method. Filters are weighed, before and after sampling, at 20 °C temperature and 30-35 % relative humidity in the Aerosol Filters Laboratory (Fig. 8.4) of the Izaña Atmospheric Research Centre (see Section 3.2.1). The procedure for weighing filters is similar to that described in EN-14907, except that we use a lower relative humidity (30-35 %) due to the relative humidity of the ambient air at IZO being much lower than the 50% stated by EN-14907.
- the determination of chemical composition which currently includes elemental composition (those detected by IPC-AES, i.e. Al, Ca, Fe, Mg, K, Na,...), salts (SO_4^{2-} , NO_3^- , NH_4^+ , Cl), organic carbon, elemental carbon and trace elements (those detected by IPC-MS, i.e. P, V, Ni, Cd, As, Sb, Sn,...).

The QA/QC procedure for the aerosol chemical composition programme includes:

- airflow checks and calibrations.
- the collection of blank field filters for gravimetry and chemical analysis.
- intercomparison exercises.

For the QA/QC activities, the group is equipped with four bubble flow-meter Gilibrators™ for measuring airflows from a few to tens of litres per minute (e.g. CPCs, SMPS, APS, MAAP, aethalometer nephelometer) and three pressure drop flow-meters for measuring airflows of tens of cubic metres per hour (e.g. samplers, TEOM).

The World Calibration Centre for Aerosol Physics audited the IZO aerosol programme in Nov 2006 (Tuch and Nowak, 2006). An updated report dated March 2014 is available (Rodríguez et al., 2014a).

8.3 Summary of remarkable results during the period 2017-2018

During the 2017-2018 biennium, the In situ Aerosols group mostly focused their research activities on dust and the transatlantic transport of aerosols with implications on climate.

8.3.1 Focus on Dust Research

A conceptual model, based on satellite observations and modeling, was proposed to account for the observed intra-seasonal variability of summer dust export to the Atlantic and the Mediterranean (Cuevas et al., 2017). This model is based on the use of the North African Dipole Intensity – NAFDI index, originally developed by the IARC team (Rodríguez et al., 2015). The new study connects dust and NAFDI variability with Rossby waves and the Saharan Heat Low (Fig. 8.3).

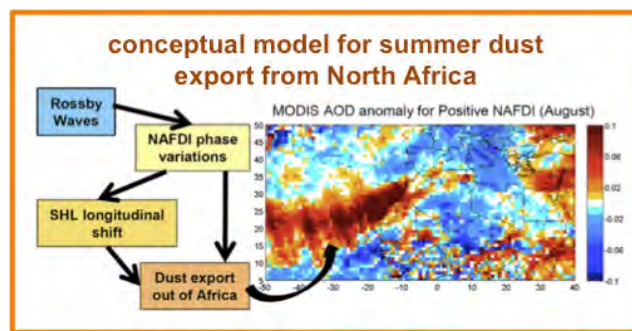

Figure 8.3. Conceptual model for summer dust export from North Africa. Reproduced from Cuevas et al. (2017).

8.3.2 Focus on Organic Aerosols

A study on the identification of the chemical composition and the sources of organic aerosols transported in the westerlies and in the Saharan Air Layer was led by the IARC team (García et al., 2017a). Biomass burning, combustion and organics linked to soil biological crust were identified as main sources (Fig. 8.4).

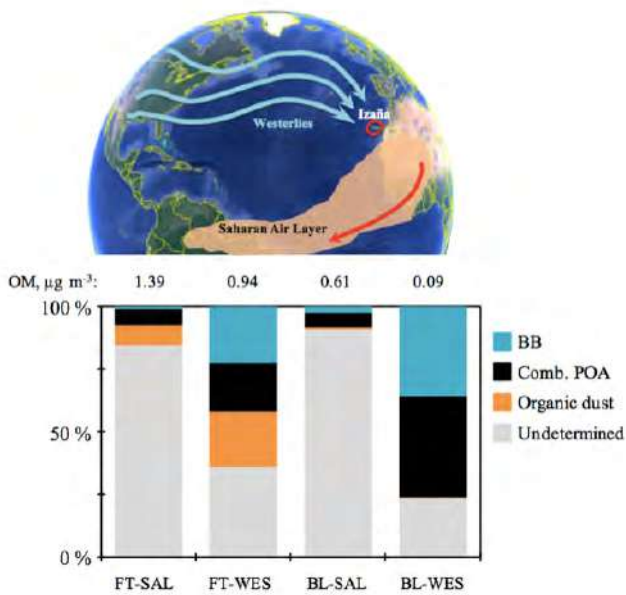

Figure 8.4. Upper panel: illustration of the westerlies and the Saharan Air Layer airflows. Lower panel: sources contributing to organic aerosol matter (OM) in the free troposphere (FT) and in the boundary layer (BL) upslope winds under westerlies (WES) and the Saharan Air Layer (SAL) airflow conditions. Sources: Biomass Burning (BB), primary combustion organic aerosols (Comb. POA), organics linked to soil dust (organic dust). Reproduced from García et al. (2017a).

8.3.3 Focus on North American Aerosols

The chemical composition, the source regions, and transatlantic transport pathways of aerosols from North America to Izaña were studied and presented in a <climatology> format (García et al., 2017b). Aerosol export from North America is enhanced by the eastward propagating cyclones and the associated fronts (Fig. 8.5). The warm and humid Gulf Inflow (by Texas) plays a key role favouring the upward transport of pollutants to the mid troposphere (over Eastern US) where it experiences transatlantic transport to Europe and North Africa (Fig. 8.5).

Mass concentrations of aerosols (PM₁₀) carried by westerly winds are rather low, typically 1.2 to 4.2 µg m⁻³. It is mainly made of North American dust (53 %) linked to emissions in New Mexico, Texas and the Great Plains, non-sea-salt sulphate (14 %) linked to the coal fired power plants in NE US and a cocktail of organic aerosols which includes biogenic compounds (18 %). Because of the seasonal shift of large-scale meteorology and the North American outflow, the maximum load of dust, impacts at Izaña from February to May; of organic matter from February to May; of nss-sulphate from March to May and of elemental carbon in August and September (Fig. 8.6).

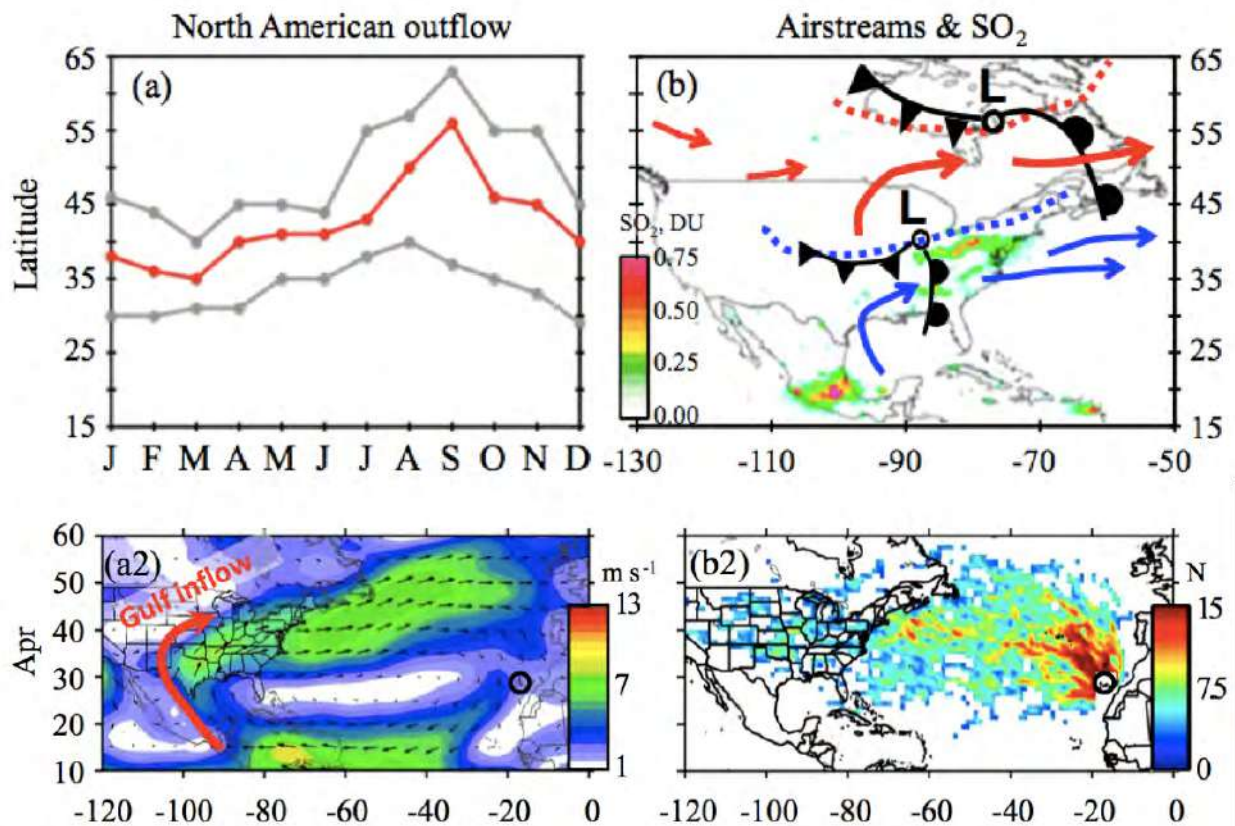

Figure 8.5. Conceptual model on the export of aerosol from North America illustrating the latitude of the North American outflow (A1), the cyclones and fronts associated with the enhancement of aerosols export to the Atlantic (B1), the Gulf inflow and the westerly export averaged in April (as representative of the Spring season, A2) and the associated transport pathway (B2). Reproduced from García et al. (2017b).

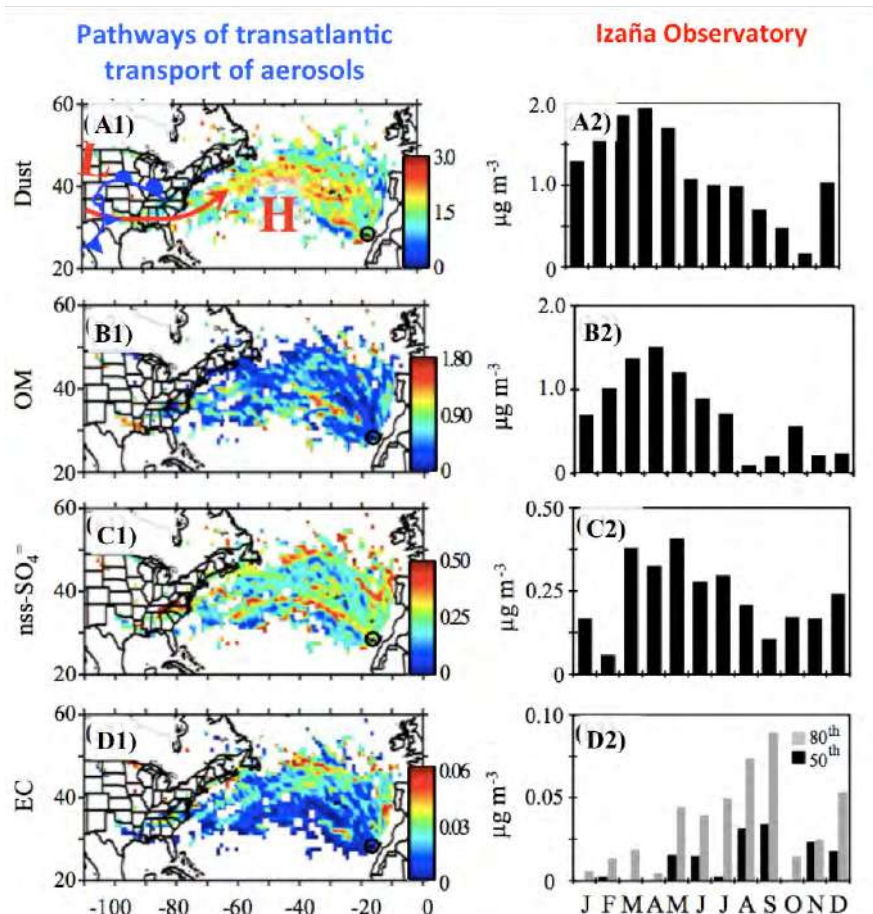

Figure 8.6. Median Concentration At Receptor (MCAR) plots (left column) and monthly value of the 50th percentile (right column) for dust, organic matter (OM), non-sea-salt-sulfate (nss-SO_4^-) and elemental carbon (EC). Reproduced from García et al. (2017b).

8.3.4 Quantification of Dry and Wet Deposition Fluxes

IARC contributed to a study quantifying dry and wet deposition fluxes in two regions of contrasting African influence (Castillo et al., 2017). Dry and wet deposition was measured at a site close to Africa (Santa Cruz de Tenerife, SCO) and at a distant site located in NE Spain (La Castanya, Montseny, MSY) (see Fig. 8.7).

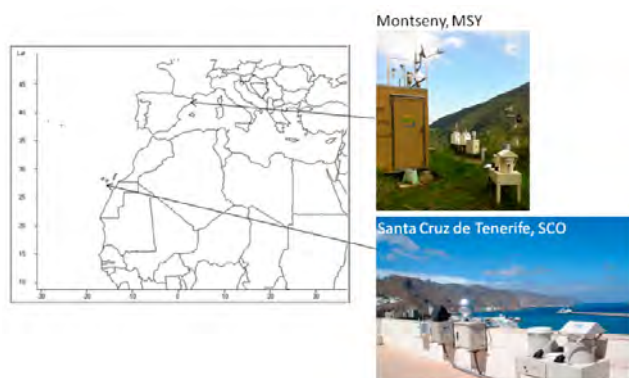

Figure 8.7. Map of the sites used in this study, Montseny (MSY) Santa Cruz de Tenerife (SCO). In the forefront of both instrument photos the wet/dry deposition collectors are shown. Reprinted from Castillo et al. (2017).

Because of the important influence of African influence on the buildup of particles in the atmosphere, the study specifically addressed the contribution of North African events (NAF events) compared to other provenances (no-NAF events) in the wet and dry pathways at the two sites. At SCO, most of the crustal-derived elements were deposited in the dry mode, with NAF events contributing more than no-NAF events. Marine elements, by contrast, were mostly deposited at this site in the wet form with a predominance of no-NAF events. At MSY, wet deposition of $\text{SO}_4\text{-S}$, $\text{NO}_3\text{-N}$ and $\text{NH}_4\text{-N}$ during NAF events was higher than at the site close to Africa, either in the wet or dry mode.

This fact suggests that mineral dust interacts with pollutants, the mineral surface being coated with ammonium, sulphate and nitrate ions as the dust plume encounters polluted air masses in its way from North Africa to the Western Mediterranean. African dust may provide a mechanism of pollution scavenging and our results indicate that this removal is more effective in the wet mode at sites far away from the mineral source.

8.4 Participation in Scientific Projects and Studies/Experiments

Additional activities included the participation in the first epidemiological study of exposure to ultrafine particles in urban areas of Spain, based on records in Santa Cruz de Tenerife, Huelva and Barcelona cities (Tobias et al., 2017). This study used a data set obtained in previous research projects led by the IARC team, which had focused on the sources (Fernández-Camacho et al., 2015; Gonález et al., 2011; González and Rodríguez, 2013; Rodríguez et al., 2007) and the impact of ultrafine particles on cardiovascular disease (Dominguez-Rodríguez et al., 2011, 2015, 2016).

The in-situ aerosols research group has also contributed to studies on ultrafine particles formation (Alonso-Blanco et al., 2018), on the influence of the topography of atmospheric observatories (Collaud Coen et al., 2018) and scattering properties of aerosol particles within the framework of the ACTRIS network (Pandolfi et al., 2018).

During this period, some of the previous cited activities where developed within the framework of the project AEROATLAN (CGL2015-66299-P) funded by the Ministry of Economy and Competitiveness of Spain and the European Regional Development Fund.

8.5 References

- Alonso-Blanco, E., Gómez-Moreno, F.J., Artiñano, B., Iglesias-Samitier, S., Juncal-Bello, V., Piñeiro-Iglesias, M., López-Mahía, P., Pérez, N., Brines, M., Alastuey, A., García, M.I., Rodríguez, S., Sorribas, M., del Águila, A., Titos, G., Lyamani, H., Alados-Arboledas, L. Temporal and spatial variability of atmospheric particle number size T distributions across Spain. *Atmospheric Environment* 190, 146–160, 2018.
- Castillo, S., A. Alastuey, E. Cuevas, X. Querol, A. Avila: Quantifying Dry and Wet Deposition Fluxes in Two Regions of Contrasting African Influence: The NE Iberian Peninsula and the Canary Islands, *Atmosphere*, 8, 5, 86; doi:10.3390/atmos8050086, 2017.
- Collaud Coen, M., Andrews, E., Aliaga, D., Andrade, M., Angelov, H., Bukowiecki, N., Ealo, M., Fialho, P., Flentje, H., Hallar, A. G., Hooda, R., Kalapov, I., Krejci, R., Lin, N.-H., Marinoni, A., Ming, J., Nguyen, N. A., Pandolfi, M., Pont, V., Ries, L., Rodríguez, S., Schauer, G., Sellegri, K., Sharma, S., Sun, J., Tunved, P., Velasquez, P., and Ruffieux, D.: Identification of topographic features influencing aerosol observations at high altitude stations, *Atmos. Chem. Phys.*, 18, 12289-12313, <https://doi.org/10.5194/acp-18-12289-2018>, 2018.
- Cuevas, E., Gómez-Peláez, A.J., Rodríguez, S., Terradellas, E., Basart, S., García, R.D., García, O.E., Alonso-Pérez, S. The pulsating nature of large-scale Saharan dust transport as a result of interplays between mid-latitude Rossby waves and the North African Dipole Intensity. *Atmos. Environ.* 167, 586-602, 2017.
- Dominguez-Rodríguez, A., Abreu-Afonso, J., Rodríguez, S., Juárez-Preda, R.A., Arroyo-Ucar, E., Jiménez-Sosa, A., González, Y., Abreu-González, P., Avanzas, P., 2011. Comparative study of ambient air particles in patients hospitalized for heart failure and acute coronary syndrome. *Rev. Esp. Cardiol.* 64, 661–666.
- Dominguez-Rodríguez, A., Rodríguez, S., Abreu-Gonzalez, P., Avanzas, Juarez-Prera Ruben A. Black carbon exposure, oxidative stress markers and major adverse cardiovascular events in patients with acute coronary syndromes. *International Journal of Cardiology* 188, 47–49, 2015.
- Dominguez-Rodríguez, A., Juárez-Prera, R.A., Rodríguez, S., Abreu-Gonzalez, P., Avanza, P. Influence of meteorological conditions on hospital admission in patients with acute coronary syndrome with and without ST-segment elevation: Results of the AIRACOS study. *Medicina Intensiva*, 40, 4, 201-207, 2016.
- Fernández-Camacho, R., Brito Cabeza, I., Aroba, J., Gómez-Bravo, F., Rodríguez, S., de la Rosa, J. Assessment of ultrafine particles and noise measurements using fuzzy logic and data mining techniques. *Science of the Total Environment* 512–513, 103–113, 2015.
- García, M. I., van Drooge, B. L., Rodríguez, S., and Alastuey, A.: Speciation of organic aerosols in the Saharan Air Layer and in the free troposphere westerlies, *Atmos. Chem. Phys.*, 17, 8939-8958, <https://doi.org/10.5194/acp-17-8939-2017>, 2017a
- García, M. I., Rodríguez, S., and Alastuey, A.: Impact of North America on the aerosol composition in the North Atlantic free troposphere, *Atmos. Chem. Phys.*, 17, 7387-7404, <https://doi.org/10.5194/acp-17-7387-2017>, 2017b.
- González, Y., Rodríguez, S., Guerra García, J.C., Trujillo, J.L., García, R., 2011. Ultrafine particles pollution in urban coastal air due to ship emissions. *Atmos. Environ.* 45, 4907–4914.
- González, Y., Rodríguez, S. A comparative study on the ultrafine particle episodes induced by vehicle exhaust, a crude oil refinery and ship emissions. *Atmospheric Research* 120–121, 43–54, 2013.
- Gómez-Moreno, F.J., Alonso, E., Artiñano, B., Juncal-Bello, V., Iglesias-Samitier, S., Piñeiro Iglesias, M., López Mahía, P., Pérez, N., Pey, J., Ripoll, A., Alastuey, A., de la Morena, B.A., García, M.I., Rodríguez, S., Sorribas, M., Titos, G., Lyamani, H., Alados-Arboledas, L., Latorre, E., Tritscher, T., Bischof, O.F. Intercomparisons of Mobility Size Spectrometers and Condensation Particle Counters in the Frame of the Spanish Atmospheric Observational Aerosol Network. *Aerosol Science and Technology*, 49, 9, 2015.
- Pandolfi, M., Alados-Arboledas, L., Alastuey, A., Andrade, M., Angelov, C., Artiñano, B., Backman, J., Baltensperger, U., Bonasoni, P., Bukowiecki, N., Collaud Coen, M., Conil, S., Coz, E., Crenn, V., Dudoitis, V., Ealo, M., Eleftheriadis, K., Favez, O., Fetfatzis, P., Fiebig, M., Flentje, H., Ginot, P., Gysel, M., Henzing, B., Hoffer, A., Holubova Smejkalova, A., Kalapov, I., Kalivitis, N., Kouvarakis, G., Kristensson, A., Kulmala, M., Lihavainen, H., Lunder, C., Luoma, K., Lyamani, H., Marinoni, A., Mihalopoulos, N., Moerman, M., Nicolas, J., O'Dowd, C., Petäjä, T., Petit, J.-E., Pichon, J. M., Prokopciuk, N., Putaud, J.-P., Rodríguez, S., Sciare, J., Sellegri, K., Swietlicki, E., Titos, G., Tuch, T., Tunved, P., Ulevicius, V., Vaishya, A., Vana, M., Virkkula, A., Vratolis, S., Weingartner, E., Wiedensohler, A., and Laj, P.: A European aerosol phenomenology – 6: scattering properties of atmospheric aerosol particles from 28 ACTRIS sites, *Atmos. Chem. Phys.*, 18, 7877-7911, <https://doi.org/10.5194/acp-18-7877-2018>, 2018.
- Rodríguez, S., Van Dingenen, R., Putaud, J.-P., Dell'Acqua, A., Pey, J., Querol, X., Alastuey, A., Chenery, S., Ho, K.-F., Harrison, R., Tardivo, R., Scarnato, B., Gemelli, V., 2007. A study on the relationship between mass concentrations, chemistry and number size distribution of urban fine aerosols

in Milan, Barcelona and London. *Atmos. Chem. Phys.* 7, 2217–2232, 2007.

Rodríguez, S. Updated report of the in-situ aerosol program at Izaña, and feedback to the WCCAP report of the November 2006 audit. March 2014, 2014. <http://www.wmo-gaw-wcc-aerosol-physics.org/files/station-replay-Izana-2006-Update-Report-by-s.rodriguez-20140325.pdf>

Rodríguez, S., Cuevas, E., Prospero, J. M., Alastuey, A., Querol, X., López-Solano, J., García, M. I., and Alonso-Pérez, S.: Modulation of Saharan dust export by the North African dipole, *Atmos. Chem. Phys.*, 15, 7471-7486, 2015.

Tobías, A., Rivas, I., Reche, C., Alastuey, A., Rodríguez, S., Fernández-Camacho, R., Sánchez de la Campa, A.M., de la Rosa, J., Sunyer, J., Querol, X. Short-term effects of ultrafine particles on daily mortality by primary vehicle exhaust versus secondary origin in three Spanish cities. *Environment International* 111, 144–151, 2018.

8.6 Staff

Dr Sergio Rodríguez* (AEMET; former Head of programme) left IARC in July 2018

Dr Natalia Prats (AEMET; Acting Head of programme)

Dr Elisa Sosa Trujillo (AEMET; Research Scientist) left IARC in December 2018

Dr Isabel García (ULL/AEMET; PhD Student) left IARC in June 2017

Ramón Ramos (AEMET; Head of Infrastructure)

Concepción Bayo-Pérez (AEMET; Meteorological Observer-GAW Technician)

9 Column Aerosols

9.1 Main Scientific Goals

The main scientific goals of this programme are:

- Long-term high quality measurements of column aerosol properties in the FT and the MBL.
- Aerosol characterization in the Saharan Air Layer and Marine Boundary Layer.
- Development of new methodologies and instrumentation for column aerosols and water vapour observations, as well as new calibration techniques.
- Mineral dust model validation.
- Satellite borne aerosol data validation.
- Provision of accurate sun and lunar photometer calibrations and intercomparisons.

9.2 Measurement Programme

The measurement programme is very extensive and includes remote sensing sensors at three of the IARC stations, IZO, SCO and TPO (see Tables 3.2, 3.4 and 3.6) and in collaborative stations abroad.

Two of the most important parameters for long-term monitoring of the evolution of the atmospheric aerosol are Aerosol Optical Depth (AOD), which accounts for the amount of aerosols found in the atmospheric column, and the Angström Exponent (AE) which gives information on the size of the particles. Measurements of AE allow us to estimate the type of aerosols we are observing. Both parameters have been measured at IZO since 2004 and SCO since 2005, as AERONET stations (Fig. 9.1) and at IZO also within the WMO Global Atmosphere Watch - Precision Filter Radiometer (GAW-PFR) network since July 2001.

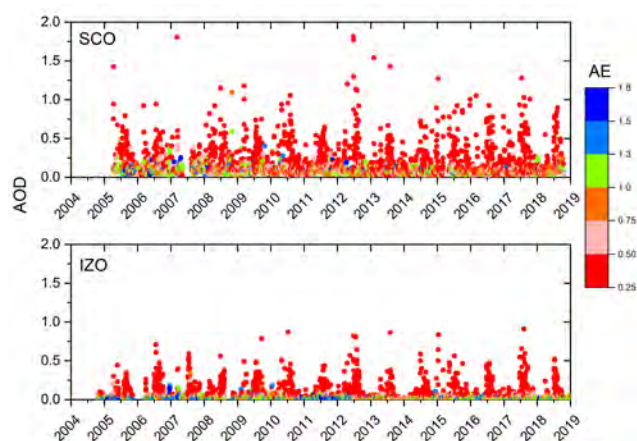

Figure 9.1. Long-term AOD and AE data series at SCO and IZO (2004-2018).

The IARC manages the AERONET sites of IZO (Fig. 9.2), SCO (Fig. 9.3) and TPO, and collaborates closely with the Tamanrasset site (Algeria). In addition IARC collaborates and provides technical assistance to the Cairo (Egypt)

AERONET site. This unique network provides dust information near dust sources over the Sahara and is a key observational facility, within the SDS-WAS Regional Center (see Section 18), for dust modelling, verification and validation of the satellite-based aerosol products.



Figure 9.2. Cimel masters of the AERONET-EUROPE Calibration Facility at Izaña Atmospheric Observatory and two PANDORA photometers (in the foreground) on a hazy day.



Figure 9.3. Cimel at Teide Santa Cruz (SCO). On the right, a ZEN radiometer and on the left a tube to prevent direct sunlight and reflections in the NASA-MPLNet Lidar located in the room below.

Another quality assurance activity is the routine performance of sunphotometer calibrations using the Langley plot technique (since 2011). IZO, besides being a station of the GAW-PFR network is one of the pristine conditions sites, together with Mauna-Loa, to perform Langley calibrations of the World Radiation Center PFR-Master (Wehrli, 2000; Kouremeti et al., 2016; Toledano et al., 2018).

Cimel Masters from AERONET, AERONET-Europe and the China Aerosol Remote Sensing NETWORK (CARSNET), managed by the China Meteorological Administration (CMA; Key Laboratory of Atmospheric Chemistry, Centre for Atmosphere Watch and Services, Chinese Academy of Meteorological Sciences), are periodically calibrated at Izaña Observatory. CARSNET has 37 operational sites including the Waliguan global GAW station (Che et al., 2009).

Langley calibrations of AERONET Cimel sun photometers are complemented with laboratory radiance calibration using the integrating sphere of the Optical calibration facility at IZO (Guirado et al., 2012).

At the end of 2017 three new Cimel CE318T (Triple) photometers and an integrating sphere were purchased in the frame of the project entitled “Equipment for the Monitoring and Research on the atmospheric components that cause and modulate climate change at the Izaña GAW (Global Atmospheric Watch) (Tenerife)” (contract n° AEDM15-BE-3319). This R+D infrastructure project has been financed by the State Research Agency of the Ministry of Economy, Industry and Competitiveness, in the Call for projects of scientific equipment, co-financed with ERDF funds.



Figure 9.4. Electronic boxes of the three Cimel CE318-T photometers (#1089, #1090, and #1091).

The CE318-T photometer measures at 340-380-440-500-675-870-936-1020-1640 nm wavelengths, and performs three types of measurement: to the sun (SUN mode), to the moon (MOON mode) and to the sky (SKY mode) in the parallel plane and in the almucantar (Barreto et al., 2017). With the first two modes AOD is determined in these channels, as well as column water vapor (precipitable water) with the 936 nm channel, while the sky measurements allow us to obtain, through inversion algorithms, a large number of optical properties and size distribution of atmospheric aerosols. Uncertainties in the determination of AOD during the night period range between 0.011 and 0.018 in the case of reference instruments, and between 0.012 and 0.021 for field instruments (Barreto et al., 2017).

These new three photometers (Fig. 9.4) have been incorporated into the NASA AERONET network and the ACTRIS AERONET-Europe network. The most accurate photometer (#1089) is permanently run at Izaña as the Primary Cimel reference, while #1090 and #1091 will be operated at TPO and SCO until the start of the ACTRIS CARS project during which travelers will be acting as reference photometers that will be sent to GOA-UVA every three months, approximately, so that our GOA-UVA colleagues can transfer the calibration to Cimel field instruments in the framework of this same project. In addition, the primary reference instrument will play an important role since it will be continuously compared against the WMO-GAW AOD reference, becoming a key link in traceability between AERONET and GAW-PFR networks.

The new Ulbricht 20 inch integrating sphere contains four lamps. It is used to perform the radiance calibrations of the CE318-T in SKY mode (Fig. 9.5).



Figure 9.5. The new Ulbricht 20 inch integrating sphere.

The Ulbricht sphere has been integrated into AERONET and AERONET-Europe, as it has the same characteristics as those integrating spheres of the NASA's Goddard Space Flight Center (Greenbelt, Maryland, USA), the GOA-UVA and the LOA-Lille. The intercomparability between the four spheres is ensured by annual calibrations of the three Europeans compared to that of NASA, which transfers its calibration by means of a traveling CE318 photometer dedicated exclusively to this task (see section 3.1.1.)

The IARC and the Spanish Institute for Aerospace Technology (PI: Dr Margarita Yela) co-manage a Micropluse lidar (MPL-3) aerosols programme, belonging to the NASA Micro-Pulse Lidar Network (MPLNet) network, which started a long-term observation programme in 2005. The instrument is part of the NASA MPLNET worldwide aerosol lidar network. It operates in full-time continuous mode (24 hours a day / 365 days a year) except around noon time periods during the summer solstice. The instrument operated at SCO is the unique aerosol lidar in Northern Africa that provides information about the vertical structure of the Saharan Air Layer over the North Atlantic.

This lidar already reached its maximum lifetime, and in May 2018 it was replaced by a new MPL-4B lidar provided by NASA Goddard Space Flight Center MPLNET (Fig. 9.6). This MPL-4B lidar was provided until IARC acquires a new instrument to be installed at SCO, this is planned in late 2019/early 2020. This new system is able to provide the common features of the previous MPL-3 version in addition to dual polarization backscatter measurements allowing researchers to discriminate between aerosol types and clouds phase. This is done by using a ferroelectric liquid crystal (FLC) for faster data rates and a slightly modified measurement strategy to accommodate the difference in polarizer properties. The main technical characteristics of the MPL-4 are detailed in Table 9.1.



Figure 9.6. Installation of the new MPL-4 by Sebastian A. Stewart (MPLNET Senior Engineer) at SCO. Ramón Ramos, Yballa Hernández and África Barreto, receiving training on the new instrument.

Table 9.1. Technical characteristics of the Micro-Pulse Lidar (MPL) at Santa Cruz de Tenerife Observatory.

Micro-Pulse Lidar version 4 (MPL-4B)	
Transmitter	
Laser	Nd:YAG
Wavelength	532 nm
Pulse repetition rate	2500 Hz
Pulse energy	6-8 μ J
Receiver	
Type	Maksutov Cassegrain
Diameter	18 cm
Focal	240 mm
Field of view	Dual field of view configuration: Narrow FOV: 100 μ rad Wide FOV: 2 mrad
Polarization	Co-polar and cross-polar components
Detector	
Type	Avalanche photodiode (APD)
Mode	Photocounting

The MPL-4 enhanced capabilities have been used to study an intrusion of biomass-burning pollution during a desert-dust episode at the Izaña atmospheric Observatory. The evolution of the depolarization ratio in the atmospheric column above Santa Cruz station in a sequence of consecutive days, is presented in Fig. 9.7. This information

will be used in a future scientific study on properties of biomass burning mixed with Saharan dust.

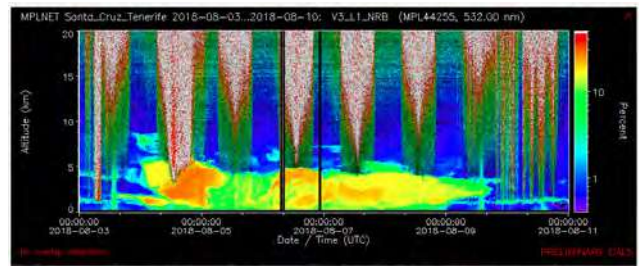

Figure 9.7. Evolution of the MPL-4 lidar depolarization ratio in the atmospheric column above Santa Cruz de Tenerife station from 3-11 August 2018.

Meanwhile, the old MPL-3 lidar was installed in October 2018 in the new Lidar facility at IZO in order to provide, for almost a year, simultaneous measurements with two MPLs, one located at sea level, and one located in Izaña (2373 m a.s.l.), along with measurements of their co-located AERONET photometers (Fig. 9.8)

In addition to the MPL-3 and MPL-4, there is also a Cimel CE376 lidar, which works at two wavelengths (532 & NIR < 850 nm) with two depolarization channels. This lidar complements the existing MPL at SCO, its main mission is to characterize the Saharan Air Layer (SAL) and cloudiness (mainly cirrus and altostratus associated to the top of the SAL) using synergy with a network of AERONET photometers located at three altitudes (SCO, IZO and PTO) and without being affected by the marine boundary layer. This instrument is still subject to adjustments and calibrations at IZO where it will be installed after the old MPL-3 is moved to a new INTA site in the Spanish peninsula which is planned during autumn 2019. The main technical characteristics of the CE376 lidar are shown in Table 9.2.

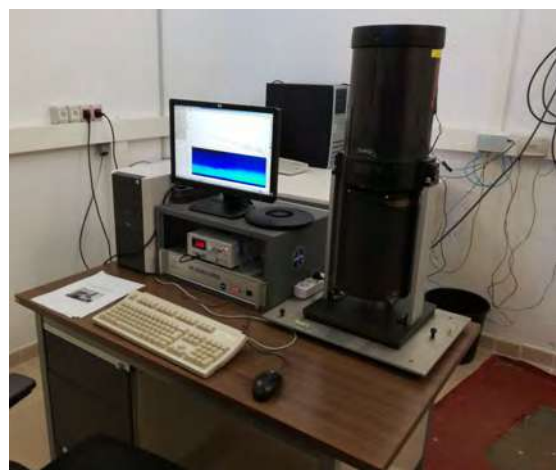

Figure 9.8. The MPL-3 from INTA, at the lidar facility at IZO (installed in October 2018).

Table 9.2 Technical characteristics of the CE376 Lidar at Santa Cruz de Tenerife Observatory.

Cimel CE376 lidar	
Transmitter	
Laser	Green laser: frequency doubled Nd:YAG NIR laser: pulsed laser diode
Wavelength	Green: 532 nm NIR: < 850 nm
Pulse repetition rate	5000 Hz
Pulse energy	Green: 5-10 μ J NIR: 3-5 μ J
Receiver	
Type	Galilean
Diameter	10 cm for both emission and reception
Focal	200 mm
Total beam divergence	Emission: Green: 100 μ rad, NIR: <250 μ rad Reception : Green: 200 μ rad, NIR: <300 μ rad
Detector	
Type	Avalanche photodiode (APD) APD QE 55% / 70%
Mode	Photocounting

As part of the WMO Commission for Instruments and Methods of Observations (WMO-CIMO) Izaña Testbed for Aerosols and Water Vapour Remote Sensing Instruments some activities related to column aerosol measurements, and specifically with methodological and instrument developments have been undertaken (see Sections 21 and 22).

9.3 Summary of remarkable results during the period 2017-2018

The most relevant results obtained during the reporting period are summarized hereinafter.

9.3.1 Long-term aerosol optical depth (1941-2017) at the Izaña Observatory

A 77-year time series of the daily AOD at 500 nm has been reconstructed from 1941 to 2017 at the IZO (Fig. 9.9). For this purpose, we have combined AOD estimates from Artificial Neuronal Networks (ANNs) from 1941 to 2001, and AOD measurements from AERONET (Cimel photometer) between 2003 and 2017. The analysis is limited to cloud-free conditions (oktas = 0) and for the month of July, where the largest aerosol load is observed at IZO (Saharan dust particles).

ANNs have proved to be a very useful tool to reconstruct AOD time series from in situ meteorological measurements (Nd, VIS, FCS and RH). The agreement between AOD ANNs estimates and measurements is rather good, with Pearson correlation coefficients (R) > 0.90.

The AOD time-series has been compared with long-term meteorological records identifying Saharan dust events at IZO. On the one hand, the number of days with $AOD \geq 0.20$ has been compared with the number of days in which the meteorological observers reported presence of suspended dust (05-06 SYNOP codes) obtaining $R = 0.88$ (Fig. 9.10a), and on the other hand we have analysed the relation between the AOD monthly medians and the monthly percentage of time the wind is blowing from the second quadrant, obtaining $R = 0.87$ (Fig. 9.10b). We conclude that the reconstructed AOD time series captures well the inter-annual AOD variations and dust-laden Saharan air mass outbreaks in a long term data series (77 years) and, thus, it is suitable to be used in climate analyses (Garcia et al., 2016; García et al., 2018).

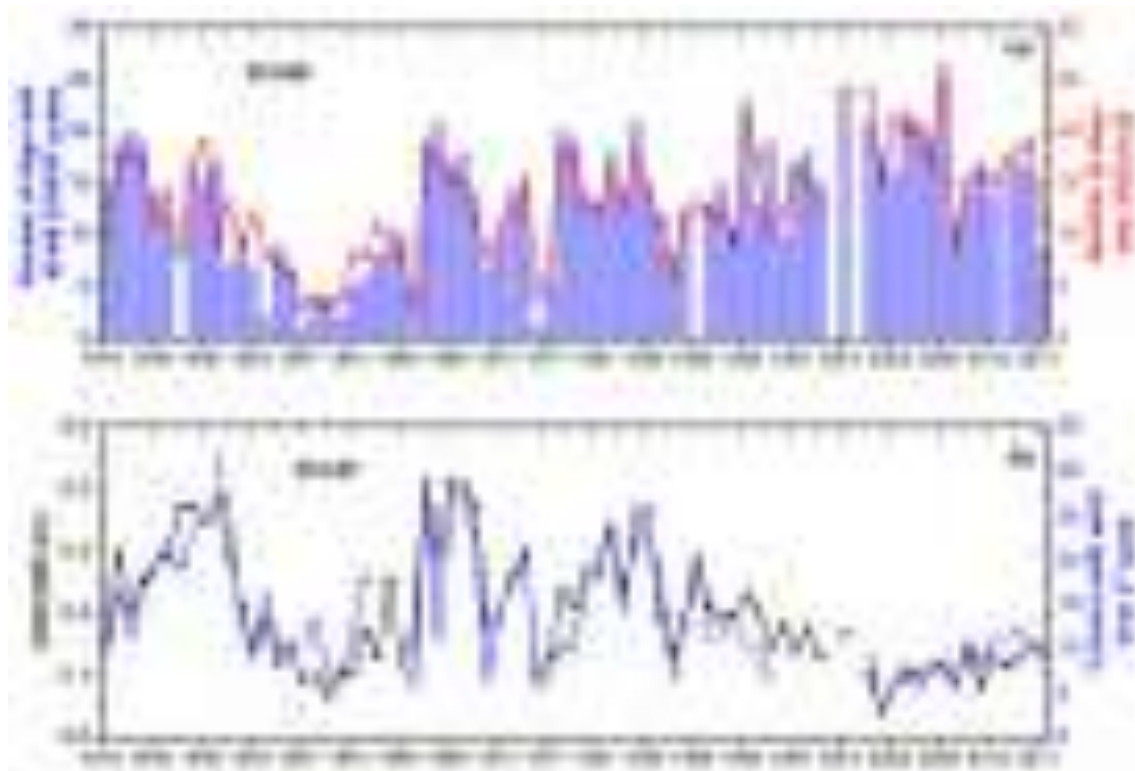

Figure 9.9 Times series of (a) number of days with SYNOP data reporting dust in suspension (05–06 SYNOP codes) on the left axis (bars), and number of days with AOD ≥ 0.20 (red line) on the right axis and (b) AOD monthly medians (black line) and monthly percentage of time the wind blows from the second quadrant (E–S; 90° – 180°) (blue line). Reprinted from Garcia et al. (2018).

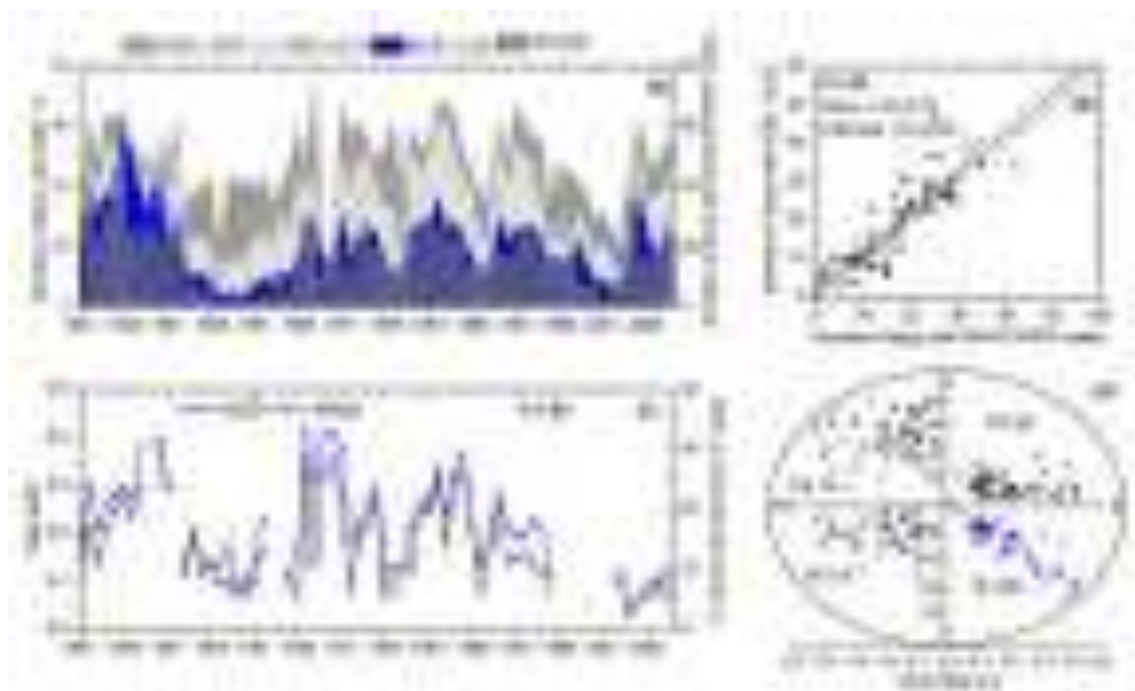

Figure 9.10 (a) Time series of the number of days grouped into ANN AOD intervals (AOD ≥ 0.05 ; AOD ≥ 0.10 ; AOD ≥ 0.20) on the left axis, while on the right axis, the bars indicate the number of days with SYNOP data reporting dust in suspension (05–06 SYNOP codes) for the period 1941–2009. The 5-year running mean are shown in black. (b) Scatterplot of number of days with ANN AOD ≥ 0.20 and number of days with 05–06 SYNOP codes. The least-square fit parameters are shown in the legend. (c) Time series of the ANN AOD monthly medians (blue line) and monthly percentage of time the wind blows from the second quadrant (E–S; 90° – 180°) (black line) at IZO in July in the period 1941–2009. (d) Percentage of time (y axis) the wind blows from in each one of the four quadrants vs. the ANN AOD monthly medians (x axis). R indicates the Pearson coefficient. Reprinted from Garcia et al., 2016.

9.3.2 The 4th WMO Filter Radiometer Comparison for aerosol optical depth measurements

The 4th Filter Radiometer Comparison (FRC-IV) was held concurrently with the 12th International Pyrheliometer Comparison (IPC-XII) in Davos, Switzerland. Instrumentation belonging to different AOD global networks were invited. The comparison took place at the premises of PMOD/WRC from 28 September – 16 October 2015. Thirty filter radiometers and spectroradiometers from 12 countries participated in this campaign.

The IARC participated in this intercomparison campaign with the new “Triple” Cimel CE318-T (#917) that had been previously calibrated at Izaña Observatory with the Langley plot technique. During 2017 and 2018 the participants in the campaign worked on the study of the intercomparison data, as well as in the preparation of the corresponding publication (Kazadzis et al., 2018).

The results showed that the absolute differences of all instruments compared to the reference have been based on the WMO criterion defined as 95 % of the measured data has to be within $0.005 \pm 0.001/m$ (where m is the air mass). At least 24 out of 29 instruments achieved this goal at both 500 and 865 nm, while 12 out of 17 and 13 out of 21 achieved this at 368 and 412 nm, respectively. While searching for sources of differences among different instruments, it was found that all individual differences linked to Rayleigh, NO₂, ozone, water vapor calculations and related optical depths and air mass calculations were smaller than 0.01 in AOD at 500 and 865 nm. Different cloud detecting algorithms used have been compared. Ångström exponent calculations showed relatively large

differences among different instruments partly because of the sensitivity of this parameter at low AOD conditions. The overall low deviations of these AOD results and the high accuracy of reference aerosol network instruments demonstrated a promising framework to achieve homogeneity, compatibility and harmonization among the different spectral AOD networks in the near-future. The Izaña Cimel Master showed one of the best AOD scores of the intercomparison with the GAW-PFR reference (Fig. 9.11).

9.3.3 Assessment of Sun photometer Langley calibration at the at the high-elevation sites Mauna Loa and Izaña

IARC contributed to a study by Toledano et al. (2018) to analyze the suitability of the high-elevation sites Mauna Loa and Izaña for Langley plot calibration of Sun photometers. The AOD characteristics and seasonality, as well as the cloudiness, have been investigated in order to provide a robust estimation of the calibration uncertainty as well as the number of days that are suitable for Langley calibrations.

The data used for the investigations belong to the AERONET and GAW-PFR networks, which maintain reference Sun photometers at these stations with long measurement records: 22 years at Mauna Loa and 15 years at Izaña. In terms of clear-sky and stable aerosol conditions, Mauna Loa (3397 m a.s.l.) exhibits on average 377 Langley plots (243 morning and 134 afternoon) per year suitable for Langley plot calibration, whereas Izaña (2373 m a.s.l.) shows 343 Langley plots (187 morning and 155 afternoon) per year (Fig. 9.12).

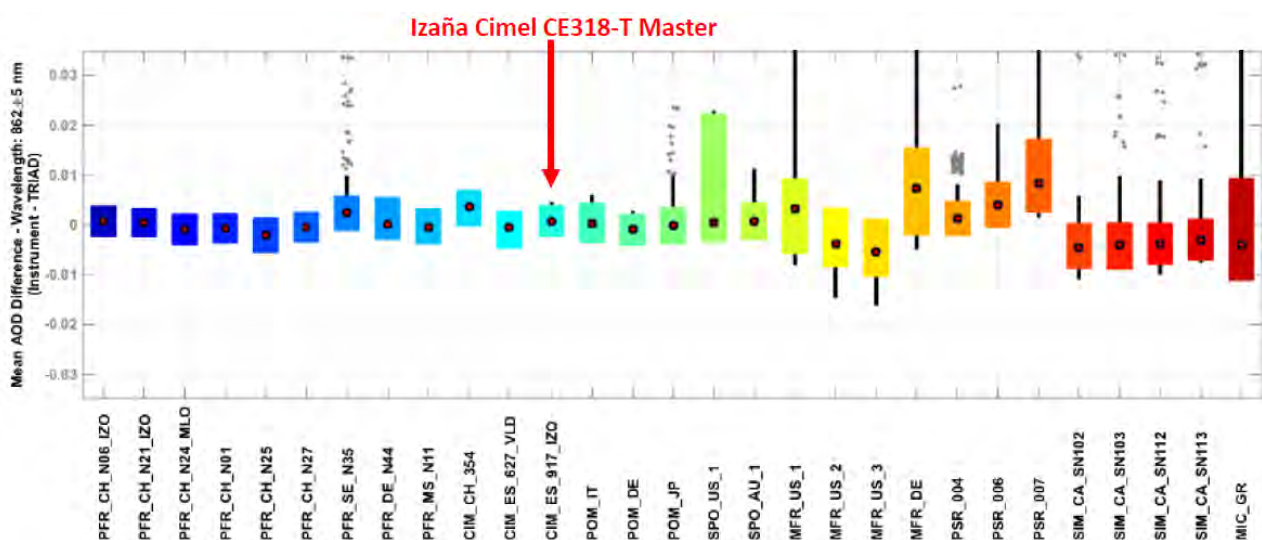

Figure 9.11. AOD comparison results at 865 ± 5 nm. The black dots represent the median of the difference of each instrument from the mean of the triad at each wavelength over the five FRC-IV selected days. The boxes represent the 10th and 90th percentiles, while the black lines represent the minimum and maximum values of the distribution excluding the outliers. Outliers (gray dots) represent values that are outside the 10th and 90th percentiles by 4 times the width of the distribution at a 10 % level. Box colors are only used to differentiate between instruments. Blue lines represent the ± 0.09 limits. Adapted from Kazadzis et al. (2018). The red arrow indicates the Izaña Cimel Master.

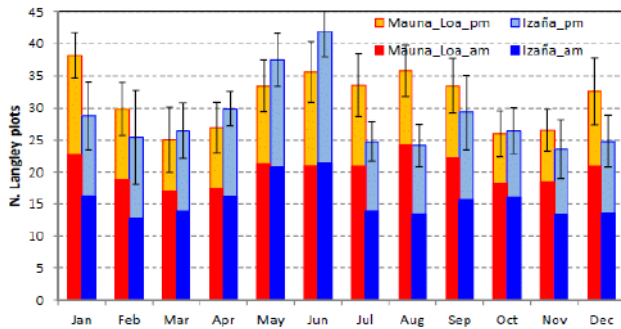

Figure 9.12. Mean number of suitable Langley calibrations per month at Mauna Loa and Izaña based on GAW-PFR and AERONET data. Bars indicate ± 1 standard deviation for each month due to year-to-year variability. Morning (“am”) and afternoon (“pm”) Langley plot calibrations are given separately. Reprinted from Toledano et al. (2018).

The background AOD (500 nm) values, on days that are favorable for Langley calibrations, are in the range 0.01–0.02 throughout the year, with well-defined seasonality that exhibits a spring maximum at both stations plus a slight summer increase at Izaña. The statistical analysis of the long-term determination of extraterrestrial signals yields a calibration uncertainty of $\sim 0.25\text{--}0.5\%$, this uncertainty being smaller in the visible and near-infrared wavelengths and larger in the ultraviolet wavelengths. This is due to atmospheric variability produced by changes in several factors, mainly the AOD. The uncertainty cannot be reduced based only on quality criteria of individual Langley plots and averaging over several days is shown to reduce the uncertainty to the needed levels for reference Sun photometers.

9.3.4 Aerosol Optical Depth comparison between GAW-PFR and AERONET-Cimel radiometers

A study was conducted of a comprehensive comparison of more than 70,000 synchronous 1-min AOD data from three GAW Watch precision-filter radiometers (GAW-PFR), traceable to the World AOD reference, and 15 Aerosol Robotic Network Cimel radiometers (AERONET-Cimel), calibrated individually with the Langley plot technique. The comparison was performed for four common or “near” wavelengths, 380, 440, 500 and 870 nm, in the period 2005–2015.

The goal of this study was to assess whether, despite the marked technical differences between both networks (AERONET, GAW-PFR) and the number of instruments used, their long-term AOD data are comparable and consistent. The percentage of data meeting the WMO traceability requirements (95 % of the AOD differences of an instrument compared to the WMO standards lie within specific limits) was $> 92\%$ at 380 nm, $> 95\%$ at 440 nm and 500 nm, and 98% at 870 nm (Fig. 9.13). The results were

quite similar for both AERONET version 2 (V2) and version 3 (V3).

For the data outside these limits, the contribution of calibration and differences in the calculation of the optical depth contribution due to Rayleigh scattering and O_3 and NO_2 absorption had a negligible impact. For $AOD > 0.1$, a small but non-negligible percentage ($\sim 1.9\%$) of the AOD data outside the WMO limits at 380 nm can be partly assigned to the impact of dust aerosol forward scattering on the AOD calculation due to the different field of view of the instruments. Due to this effect the GAW-PFR provides AOD values, which are $\sim 3\%$ lower at 380 nm and $\sim 2\%$ lower at 500 nm compared with AERONET-Cimel. This long-term comparison shows an excellent traceability of AERONET-Cimel AOD with the World AOD reference at 440, 500 and 870 nm channels and a fairly good agreement at 380 nm, although AOD should be improved in the UV range.

Although the results of the intercomparison between the instruments used by the two most important radiometric networks globally for AOD measurements show an excellent agreement, in this study a great effort has been made to understand the causes of the differences in AOD. To this end, a detailed analysis of almost all the instrumental and methodological factors that may explain the differences in the AOD determination by these two radiometers has been carried out. Therefore, this study constitutes a comprehensive paper review on AOD measurements with solar radiometry.

This work has been performed in the frame of the WMO CIMO Izaña test bed for aerosols and water vapour remote-sensing instruments funded by AEMET, together with the Physikalisch-Meteorologisches Observatorium Davos, World Radiation Center (PMOD-WRC) (Davos, Switzerland), the Finnish Meteorological Institute (Helsinki, Finland), the Atmospheric Optics Group, Valladolid University (Valladolid, Spain) and Cimel Electronique (Paris, France). This study was published by Cuevas et al. (2018) in the discussion phase of the Atmospheric Measurement Technique (AMT) journal. During the writing of this report, the paper was published in its final version (Cuevas et al., 2019).

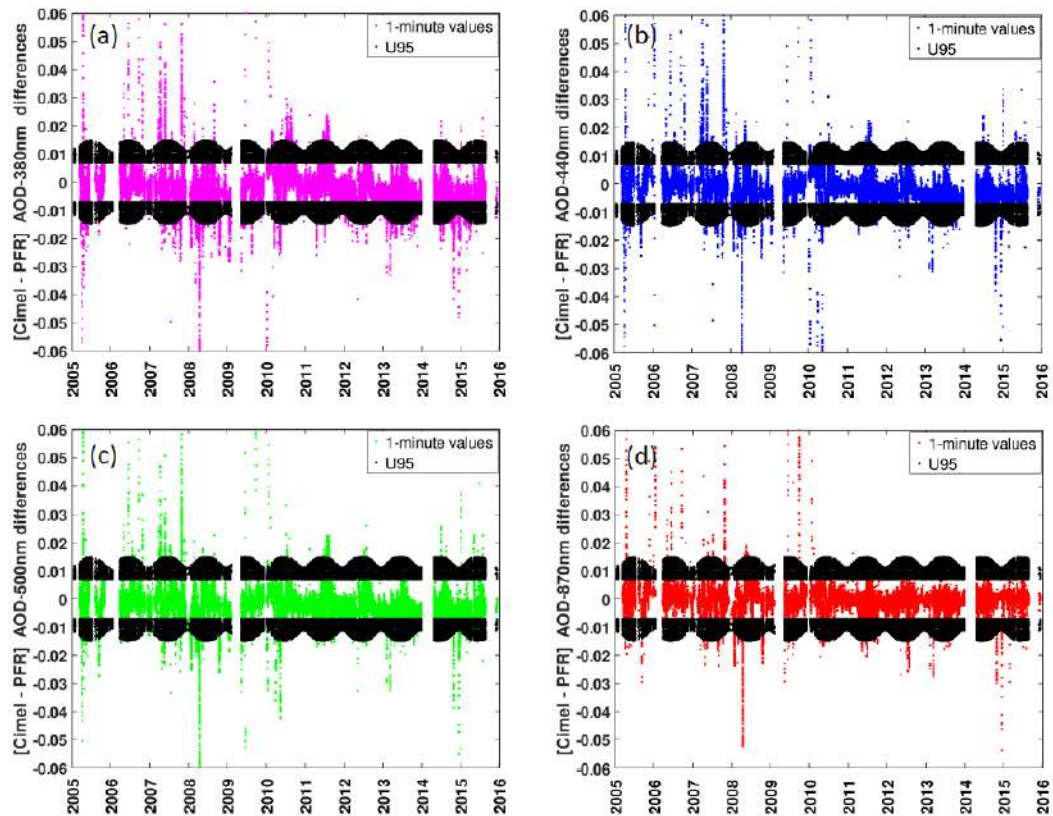

Figure 9.13. 1-minute AOD data differences between AERONET-Cimel and GAW-PFR for (a) 380 nm (70838 data-pairs), (b) 440 nm (71645 data-pairs), (c) 500 nm (70833 data-pairs) and (d) 870 nm (71660 data-pairs) for the period 2005-2015. Black dots correspond to the U95 limits. Some outliers are out of the ± 0.06 AOD differences range. Reprinted from Cuevas et al. (2019).

Also in the framework of the WMO SDS-WAS we participated in a study aimed to evaluate the predictions of five state-of-the-art dust forecast models during an intense Saharan dust outbreak affecting western and northern Europe in April 2011 (Huneeus et al., 2016). The capacity of the models to predict the evolution of the dust cloud with lead-times of up to 72 h using observations of AOD from AERONET and the Moderate Resolution Imaging Spectroradiometer (MODIS), and dust surface concentrations from a ground-based measurement network was assessed.

9.3.5 New developments using GRASP algorithm

We have contributed to two new developments for the determination of the optical properties of aerosols through GRASP (Generalized Retrieval of Aerosol and Surface Properties) during the reporting period. GRASP is a highly accurate aerosol retrieval algorithm that processes properties of aerosol- and land-surface-reflectance. It infers nearly 50 aerosol and surface parameters including particle size distribution, the spectral index of refraction, the degree of sphericity and absorption.

The first contribution was on the aerosol properties (refractive indices, fraction of spherical particles and size distribution parameters) retrievals from normalized camera radiances at lunar almucantar points (up to 20° in azimuth from the Moon) at three effective wavelengths from two

High Dynamic Range (HDR) images. The retrievals were compared with the nearest diurnal AERONET products showing a good agreement. These results have been published in Roman et al. (2017).

The second contribution was providing lunar observations to an assessment study on the potential of using AOD measurements to characterize the microphysical and optical properties of atmospheric aerosols using GRASP. This study used optical depth observations at eight AERONET locations to validate the new results with the standard AERONET inversion products. The authors found that bimodal log-normal size distributions serve as useful input assumptions, especially when the measurements have inadequate spectral coverage and/or limited accuracy, such as moon photometry. Comparisons of the mode median radii between GRASP-AOD and AERONET indicate that for dominant mode (i.e. fine or coarse) a 10% difference in mode radii between the GRASP-AOD and AERONET inversions, and the average of the difference in volume concentration is around 17% for both modes. The retrieved values of the fine-mode AOD_{500nm} using GRASP-AOD are generally between those values obtained by the standard AERONET inversion and the values obtained by the AERONET spectral deconvolution algorithm (SDA), with differences typically lower than 0.02 between GRASP-AOD and both algorithms.

9.3.6 Assessment of aerosol data requirements for numerical atmospheric aerosol prediction

The IARC contribution to the assessment paper of Benedetti et al. (2018) is important because it involves being part of the research team responsible for identifying the aerosol data requirements needed for the future numerical prediction of aerosols, led by Copernicus.

Numerical prediction of aerosol particle properties has become an important activity at many research and operational weather centers. This development is due to growing interest from a diverse set of stakeholders, such as air quality regulatory bodies, aviation and military authorities, solar energy plant managers, climate services providers, and health professionals. Owing to the complexity of atmospheric aerosol processes and their sensitivity to the underlying meteorological conditions, the prediction of aerosol particle concentrations and properties in the numerical weather prediction (NWP) framework faces a number of challenges.

This study reviews current requirements for aerosol observations (Fig. 9.14) in the context of the operational activities carried out at various global and regional centers

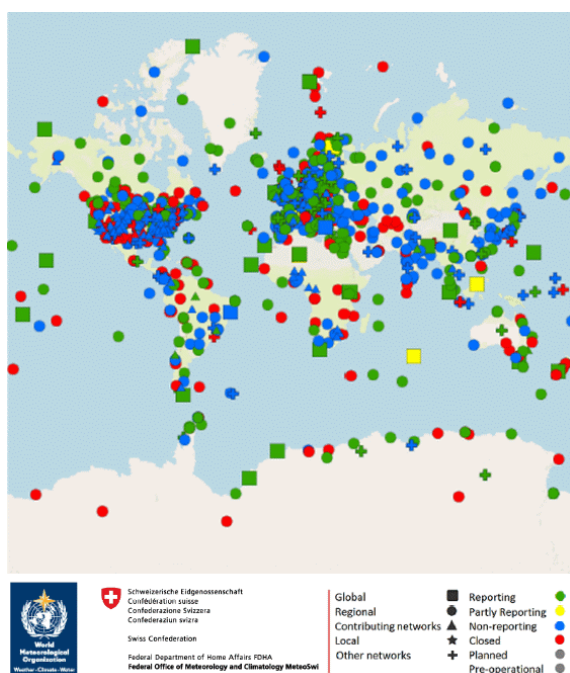

Figure 9.14. Map of surface stations currently included in GAWSIS. Reprinted from Benedetti et al. (2018).

While some of the requirements are equally applicable to aerosol–climate, the focus here is on global operational prediction of aerosol properties such as mass concentrations and optical parameters. It is also recognized that the term “requirements” is loosely used here given the diversity in global aerosol observing systems and that utilized data are typically not from operational sources. Most operational models are based on bulk schemes that do not predict the size distribution of the aerosol particles. Others are based on

a mix of “bin” and bulk schemes with limited capability of simulating the size information. However the next generation of aerosol operational models will output both mass and number density concentration to provide a more complete description of the aerosol population. A brief overview of the state of the art is provided with an introduction on the importance of aerosol prediction activities. The criteria on which the requirements for aerosol observations are based are also outlined. Assimilation and evaluation aspects are discussed from the perspective of the user requirements.

9.3.7 Cooperation with CARSNET (China)

Aerosol pollution in eastern China is an unfortunate consequence of the region’s rapid economic and industrial growth. Che et al. (2018) published a study on Cimel CE318 sunphotometer measurements from seven sites in the Yangtze River Delta (YRD) from 2011 to 2015. These instruments were standardized and calibrated using CARSNET reference instruments, which in turn were periodically calibrated at Izaña Observatory in conjunction with the AERONET program and within the ACTRIS AERONET-Europe service.

The study characterized the climatology of aerosol microphysical and optical properties, calculated direct aerosol radiative forcing (DARF) and classified the aerosols based on size and absorption. Bimodal size distributions were found throughout the year, but larger volumes and effective radii of fine-mode particles occurred in June and September due to hygroscopic growth and/or cloud processing. Increases in the fine-mode particles in June and September caused AOD 440 nm > 1.00 at most sites, and annual mean AOD 440 nm values of 0.71–0.76 were found at the urban sites and 0.68 at the rural site. The AOD 440 nm was lower in July and August (~0.40–0.60) than in January and February (0.71–0.89) due to particle dispersion associated with subtropical anticyclones in summer.

Single-scattering albedo at 440 nm (SSA440nm) from 0.91 to 0.94 indicated particles with relatively strong to moderate absorption. Strongly absorbing particles from biomass burning with a significant SSA wavelength dependence were found in July and August at most sites, while coarse particles in March to May were mineral dust.

The annual mean DARF was -93 ± 44 to -79 ± 39 W m⁻² at the Earth’s surface and ~ -40 W m⁻² at the top of the atmosphere (for the solar zenith angle range of 50 to 80°) under cloud-free conditions. The fine mode composed a major contribution of the absorbing particles in the classification scheme based on SSA, fine-mode fraction and extinction Angström exponent. This study contributes to our understanding of aerosols and regional climate/air quality, and the results will be useful for validating satellite retrievals and for improving climate models and remote sensing algorithms.

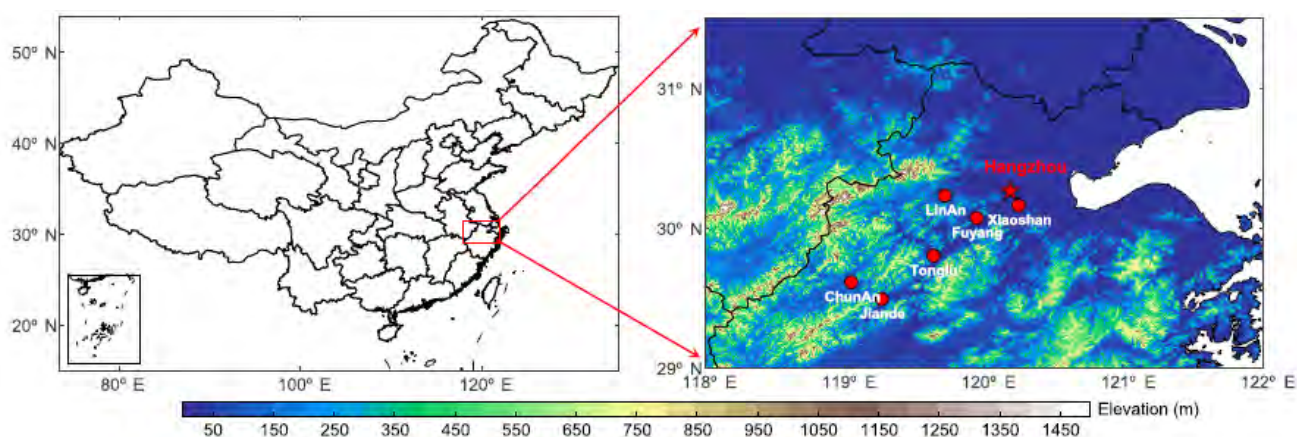

Figure 9.15. Locations and elevations of the seven CARSNET sites in the Yangtze River Delta. Reprinted from Che et al. (2018).

9.4 References

- Barreto, Á., Román, R., Cuevas, E., Berjón, A. J., Almansa, A. F., Toledano, C., González, R., Hernández, Y., Blarel, L., Goloub, P., Guirado, C., and Yela, M.: Assessment of nocturnal aerosol optical depth from lunar photometry at the Izaña high mountain observatory, *Atmos. Meas. Tech.*, 10, 3007-3019, <https://doi.org/10.5194/amt-10-3007-2017>, 2017.
- Benedetti, A., Reid, J. S., Knippertz, P., Marsham, J. H., Di Giuseppe, F., Rémy, S., Basart, S., Boucher, O., Brooks, I. M., Menut, L., Mona, L., Laj, P., Pappalardo, G., Wiedensohler, A., Baklanov, A., Brooks, M., Colarco, P. R., Cuevas, E., da Silva, A., Escribano, J., Flemming, J., Huneus, N., Jorba, O., Kazadzis, S., Kinne, S., Popp, T., Quinn, P. K., Sekiyama, T. T., Tanaka, T., and Terradellas, E.: Status and future of numerical atmospheric aerosol prediction with a focus on data requirements, *Atmos. Chem. Phys.*, 18, 10615-10643, <https://doi.org/10.5194/acp-18-10615-2018>, 2018.
- Che, H., Qi, B., Zhao, H., Xia, X., Eck, T. F., Goloub, P., Dubovik, O., Estelles, V., Cuevas-Agulló, E., Blarel, L., Wu, Y., Zhu, J., Du, R., Wang, Y., Wang, H., Gui, K., Yu, J., Zheng, Y., Sun, T., Chen, Q., Shi, G., and Zhang, X.: Aerosol optical properties and direct radiative forcing based on measurements from the China Aerosol Remote Sensing Network (CARSNET) in eastern China, *Atmos. Chem. Phys.*, 18, 405-425, <https://doi.org/10.5194/acp-18-405-2018>, 2018.
- Cuevas, E., Romero-Campos, P. M., Kouremeti, N., Kazadzis, S., García, R. D., Barreto, A., Guirado-Fuentes, C., Ramos, R., Toledano, C., Almansa, F., and Gröbner, J.: Aerosol Optical Depth comparison between GAW-PFR and AERONET-Cimel radiometers from long term (2005–2015) 1-minute synchronous measurements, *Atmos. Meas. Tech. Discuss.*, <https://doi.org/10.5194/amt-2018-438>, 2018.
- Cuevas, E., Romero-Campos, P. M., Kouremeti, N., Kazadzis, S., Räisänen, P., García, R. D., Barreto, A., Guirado-Fuentes, C., Ramos, R., Toledano, C., Almansa, F., and Gröbner, J.: Aerosol optical depth comparison between GAW-PFR and AERONET-Cimel radiometers from long-term (2005–2015) 1 min synchronous measurements, *Atmos. Meas. Tech.*, 12, 4309–4337, <https://doi.org/10.5194/amt-12-4309-2019>, 2019.
- García, R. D., García, O. E., Cuevas, E., Cachorro, V. E., Barreto, A., Guirado-Fuentes, C., Kouremeti, N., Bustos, J. J., Romero-Campos, P. M., and de Frutos, A. M.: Aerosol optical depth retrievals at the Izaña Atmospheric Observatory from 1941 to 2013 by using artificial neural networks, *Atmos. Meas. Tech.*, 9, 53-62, [doi:10.5194/amt-9-53-2016](https://doi.org/10.5194/amt-9-53-2016), 2016.
- García, R. D., O.E. García, E. Cuevas and J.J. Bustos, Long-term aerosol optical depth (1941-2017) at the Izaña Observatory. 9th International Workshop on Sand/Dust storms and Associated Dustfall, La Laguna, Tenerife, Spain, 22-24 May 2018.
- Kazadzis, S., Kouremeti, N., Diémoz, H., Gröbner, J., Forgan, B. W., Campanelli, M., Estellés, V., Lantz, K., Michalsky, J., Carlund, T., Cuevas, E., Toledano, C., Becker, R., Nyeki, S., Kosmopoulos, P. G., Tatsiankou, V., Vuilleumier, L., Denn, F. M., Ohkawara, N., Ijima, O., Goloub, P., Raptis, P. I., Milner, M., Behrens, K., Barreto, A., Martucci, G., Hall, E., Wendell, J., Fabbri, B. E., and Wehrli, C.: Results from the Fourth WMO Filter Radiometer Comparison for aerosol optical depth measurements, *Atmos. Chem. Phys.*, 18, 3185-3201, <https://doi.org/10.5194/acp-18-3185-2018>, 2018.
- Román, R., B. Torres, D. Fuertes, V.E. Cachorro, O. Dubovik, C. Toledano, A. Cazorla, A. Barreto, J.L. Bosch, T. Lapyonok, R. González, P. Goloub, M.R. Perrone, F.J. Olmo, A. de Frutos, L. Alados-Arboledas: Remote sensing of lunar aureole with a sky camera: Adding information in the nocturnal retrieval of aerosol properties with GRASP code, *Remote Sensing of Environment*, 196, 238-252, <https://doi.org/10.1016/j.rse.2017.05.013>, 2017.
- Toledano, C., González, R., Fuertes, D., Cuevas, E., Eck, T. F., Kazadzis, S., Kouremeti, N., Gröbner, J., Goloub, P., Blarel, L., Román, R., Barreto, Á., Berjón, A., Holben, B. N., and Cachorro, V. E.: Assessment of Sun photometer Langley calibration at the high-elevation sites Mauna Loa and Izaña, *Atmos. Chem. Phys.*, 18, 14555-14567, <https://doi.org/10.5194/acp-18-14555-2018>, 2018.
- Torres, B., Dubovik, O., Fuertes, D., Schuster, G., Cachorro, V. E., Lapyonok, T., Goloub, P., Blarel, L., Barreto, A., Mallet, M., Toledano, C., and Tanré, D.: Advanced characterization of aerosol properties from measurements of spectral optical depth using the GRASP algorithm. *Atmos. Meas. Tech.*, 10, 3743-3781. <https://www.atmos-meas-tech.net/10/3743/2017/>, 2017.

9.5 Staff

Dr Emilio Cuevas (AEMET; Head of programme)

Dr Carmen Guirado Fuentes (UVA/AEMET; Research Scientist) left IARC in September 2019

Dr Yballa Hernández-Pérez (AEMET; Research Scientist) left IARC in November 2018

Pedro Miguel Romero (AEMET; Research Scientist)

Ramón Ramos (AEMET; Head of Infrastructure)

Dr África Barreto (CIMEL; Research Scientist)

Dr Rosa García (Air Liquide; Research Scientist)

Dr Alberto Berjón (AEMET; Research Scientist)

Dr Sergio Fabián León Luis (AEMET; Research Scientist)

Dr Omaira García (AEMET; Research Scientist)

Fernando Almansa (CIMEL/UVA; Research Scientist)

Dr Victoria Cachorro (University of Valladolid; Head of Atmospheric Optics Group)

Dr Ángel de Frutos (University of Valladolid Atmospheric Optics Group; Research Scientist)

Dr Margarita Yela (INTA; Co-PI in MPL sub-programme)

10 Radiation

The radiation programme, and specifically the implementation of its core component, the Baseline Surface Radiation Network (BSRN) programme, has been performed in close collaboration with the [University of Valladolid Atmospheric Optics Group](#).

10.1 Main Scientific Goals

The main scientific goals of this programme are:

- To conduct high quality measurement of radiation parameters.
- To investigate the variations of the solar radiation balance and other solar energy parameters in the three radiation stations managed by the IARC.
- To investigate aerosols radiative forcing with a particular focus on the role played by dust taking advantage of the privileged situation of the Canary Islands to analyse dust outbreaks over the North Atlantic and the unique local radiation network with stations at different altitudes (from sea level to 3555 m a.s.l.).
- To recover, digitize and analyse historical radiation data in order to reconstruct long-term radiation series that allow us to make precise studies concerning sky darkening and brightening, and relate radiation to cloud cover and solar flux.
- To conduct the spectral characterization of the solar radiation: impacts of different types of clouds, aerosols, especially mineral dust, and precipitable water vapour.

10.2 Measurement Programme

Direct radiation records from an Abbot silver-disk pyrheliometer are available since 1916, although this information has not yet been analysed. Global solar radiation records from a bimetallic pyranograph are available both in bands and as daily integrated values in printed lists, since 1977. This information has been digitized, recalibrated and processed. The results show an excellent agreement between the bimetallic pyranograph and the BSRN CM21 pyranometer, which allowed the successful reconstruction of a long-term global radiation data series (since 1977), after a careful analysis of historical data (Figure 10.1).

Global and direct radiation measurements started in 1992 as part of a solar radiation project of the Canary Islands Government. In 2005, IZO joined the Spanish radiation network managed by the AEMET National Radiation Center (CNR). Since 2009, IZO has been a BSRN station providing the basic set of radiation parameters. In addition, other parameters, including shortwave and long wave upward radiation, UV-A and UV-B radiation are also

measured within the BSRN Programme. Later, some basic radiation measurements were implemented at the other three IARC measurement stations (SCO, TPO and BTO).

Radiation measurements are tested against physically possible and globally extremely rare limits, as defined and used in the BSRN recommended data quality control. Shortwave downward radiation (SDR) measurements are compared daily with SDR simulations, which are modelled with the LibRadtran model. This information has been implemented and shared in the web page <http://bsrn.aemet.es/>, where real time measurements of global, direct, diffuse and UV-B radiation are shown.

Measurements of spectral direct solar radiation (spectral direct normal irradiance) performed with an EKO MS-711 spectroradiometer (Fig. 10.2) started in 2016. This instrument covers a wavelength range from 300 to 1100 nm, exhibiting a Full Width at Half Maximum < 7 nm. It is equipped with its own built-in entrance optics, and the housing is temperature-stabilized at $25^{\circ}\pm 5^{\circ}$ (Egli et al., 2016). The main specifications of the EKO MS-711 are given in Table 10.1.

Table 10.1. Main specifications of the EKO MS-711 spectroradiometer

EKO MS-711 spectroradiometer	
Wavelength range	300 to 1100 nm
Wavelength interval	0.3 - 0.5nm
Optical resolution FWHM	< 7 nm
Wavelength accuracy	+/- 0.2 nm
Cosine Response (Zenith: 0 ~ 80°)	< 5%
Temp. dependency (-10°C to 50°C)	< 2 %
Temp. Control	25°C ± 2°C
Operating temperature	-10 to 50°C
Exposure time	10msec - 5sec Automatic adjustment
Dome material	Synthetic Quartz Glass
Communication	RS-422 (Between sensor and power supply)
Power requirement	12VDC, 50VA (from the power supply)

The EKO MS-711 spectroradiometer has been mounted on an Owel INTRA 3 sun-tracker (Fig. 10.2), an intelligent tracker which combines the advantages of automatic-tracking operation (automatic alignment with the system of astronomical coordinates follows after a few days), and actively-controlled tracking (a 4-quadrant sun sensor). It is constructed for use under extreme weather conditions; its operational temperature range is between -20 and +50 °C.

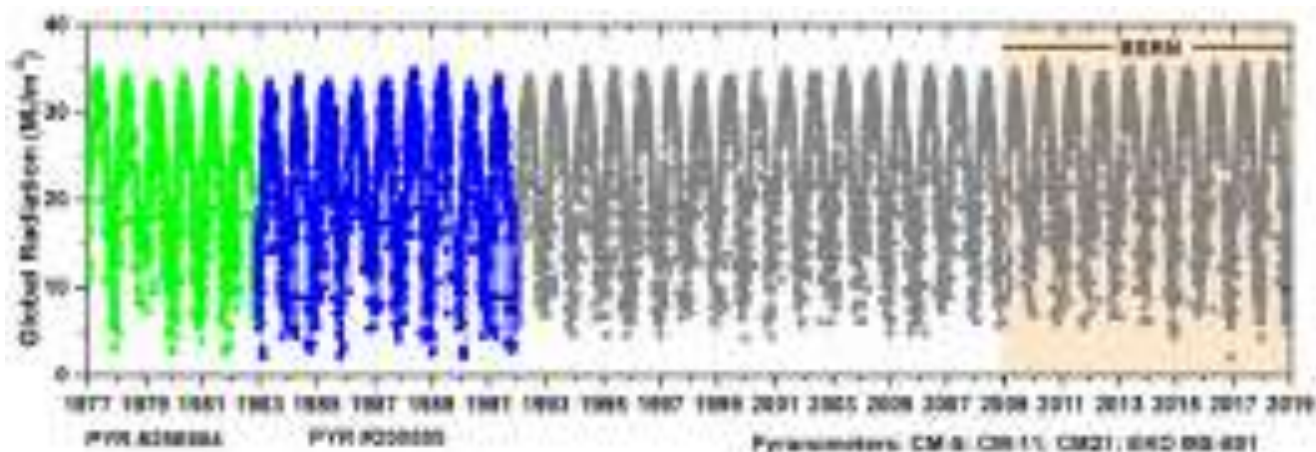

Figure 10.1. Daily GSR_H data time series between 1977 and 2018 at IZO. The green and blue dots correspond to the measurements performed with PYR #290609 and #250585, respectively, between 1977 and 1991, and the grey dots represent the measurements performed with different pyranometers (CM-5, CM-11, CM-21 and EKO MS-801) between 1992 and 2018 (García et al., 2014, 2017).

It can sustain about 50 kg of a carefully balanced load. The tracker motors have a special grease for use in low temperatures. The drive unit has an azimuth rotation $> 360^\circ$. It moves back to the start (morning) position at the corresponding midnight. The drive unit has a zenith rotation $> 90^\circ$. The unit has an angular resolution $\leq 0.1^\circ$, an angular repeatability of $\leq \pm 0.05^\circ$ and an angular velocity $\geq 1.5^\circ/s$ on the outgoing shafts. The maximum speed is $2.42^\circ/s$.



Figure 10.2. The EKO MS-711 spectroradiometer installed at IZO.

The atmospheric transmission is a product implemented in 2014, processed retrospectively back until 2009, and it has been updated until December 31st 2018 (Fig. 10.3). It is available at the IZO BSRN web page. The atmospheric transmission is derived from broadband (0.2 to $4.0\mu m$) direct solar irradiance BSRN observations. Data are for clear-sky mornings between solar elevations of 11.3° and 30° .

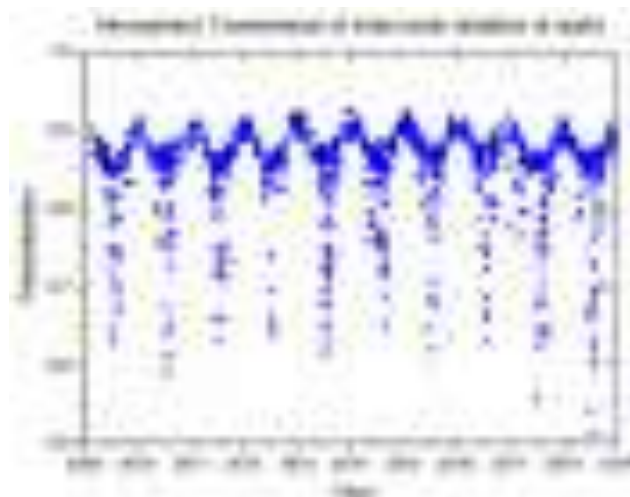

Figure 10.3. Daily atmospheric transmission data (2009-2018) at IZO computed in clear-sky mornings between solar elevations of 11.3° and 30° .

Sky images from SONA total-sky cameras at IZO and SCO, meteorological vertical profiles from radiosondes, AOD and AE from Cimel and PFR sunphotometers, column water vapour from Cimel and GPS/GLONASS, column NO_2 from DOAS, and total O_3 from Brewer spectrophotometer are used as ancillary data and/or as input data in LibRadtran simulations.

A summary of the radiation measurement programme managed by the IARC is shown in Table 10.2.

Table 10.2. Details of IARC radiation measurement programme.

Instrument	Measurements	Spectral Range
Izaña historical records (2373 m a.s.l.) Start Date: Different dates		
Abbot silver-disk pyrliometer	Direct Radiation (1916)	~0.3 to ~3.0 μm
Bimetallic pyranograph (analog.)	Global Radiation (Jan 1977)	~0.3 to ~3.0 μm
YES Multi Filter Rotating Shadow-band Radiometer	Global, diffuse and estimated direct radiation (Feb 1996)	300-1200 nm
K&Z CM5 pyranometer	Global radiation (Jan 1992)	310-2800 nm
Izaña BSRN Station (2373 m a.s.l.) Start Date: March 2009		
Pyranometer K&Z CM-21, EKO MS-801	Global and Diffuse Radiation	285-2600 nm
Pyrheliometer K&Z CH-1, EKO MS-56	Direct Radiation	200-4000 nm
Pyrgeometer K&Z CG-4	Longwave Downward Radiation	4500-42000 nm
Net Radiometer, EKO MR-60	Net Radiation	
Pyranometer K&Z UV-A-S-T	UV-A Radiation	315-400 nm
Pyranometer Yankee YES UVB-1	UV-B Radiation	280-400 nm
Absolute Cavity Pyrliometer PMO6	Direct Radiation	-
Spectroradiometer EKO MS-711	Spectral Direct Radiation	300-1100 nm
Izaña National Radiation Center (CNR) Station (2373 m a.s.l.) Start Date: August 2005		
Pyranometer K&Z CM-21	Global and Diffuse Radiation	285-2600 nm
Pyrheliometer K&Z CH-1	Direct Radiation	200-4000 nm
Pyrgeometer K&Z CG-4	Longwave Downward Radiation	4500-42000 nm
Pyranometer Yankee YES UVB-1	UV-B Radiation	280-400 nm
Pyranometer K&Z PQS1	Photosynthetically Active Radiation (PAR)	400-700 nm
SCO (52 m a.s.l.) Start Date: February 2006		
Pyranometer K&Z CM-11	Global and Diffuse Radiation	310-2800 nm
Pyrheliometer EPPLY	Direct Radiation	200-4000 nm
BTO (114 m a.s.l.) Start Date: 2009		
Pyranometer K&Z CM-11	Global and Diffuse Radiation	310-2800 nm
TPO (3555 m a.s.l.) Start Date: July 2012		
Pyranometer K&Z CM-11, CM-21	Global and Diffuse Radiation	310-2800 nm
Pyranometer Yankee YES UVB-1	UV-B Radiation	280-400 nm

10.3 Summary of remarkable results during the period 2017-2018

10.3.1 Comparison of observed and modeled cloud-free longwave downward radiation (2010–2016) at the high mountain BSRN Izaña station

A 7-year (2010–2016) comparison study between measured and simulated longwave downward radiation (LDR) under cloud-free conditions was conducted at IZO and was published by García et al. (2018). This analysis encompasses a total of 2062 cases distributed approximately evenly between day and night (Figure 10.4).

Results show an excellent agreement between Baseline Surface Radiation Network (BSRN) measurements and simulations with LibRadtran V2.0.1 and MODerate resolution atmospheric TRANsmission model (MODTRAN) V6 radiative transfer models (RTMs) (Table 10.3). Mean bias (simulated-measured) of < 1.1 % and root mean square of the bias (RMS) of < 1% are within the

instrumental error (2 %). These results highlight the good agreement between the two RTMs, proving to be useful tools for the quality control of LDR observations and for detecting temporal drifts in field instruments. The standard deviations of the residuals, associated with the RTM input parameter uncertainties are rather small, 0.47 and 0.49% for LibRadtran and MODTRAN, respectively, at daytime, and 0.49 to 0.51% at night-time.

For precipitable water vapor (PWV) > 10 mm, the observed night-time difference between models and measurements is +5 W m⁻² indicating a scale change of the World Infrared Standard Group of Pyrgeometers (WISG), which serves as reference for atmospheric longwave radiation measurements. Preliminary results suggest a possible impact of dust aerosol on infrared radiation during the daytime that might not be correctly parametrized by the models, resulting in a slight underestimation of the modeled LDR, of about -3 W m⁻², for relatively high aerosol optical depth (AOD > 0.20) (Figure 10.5).

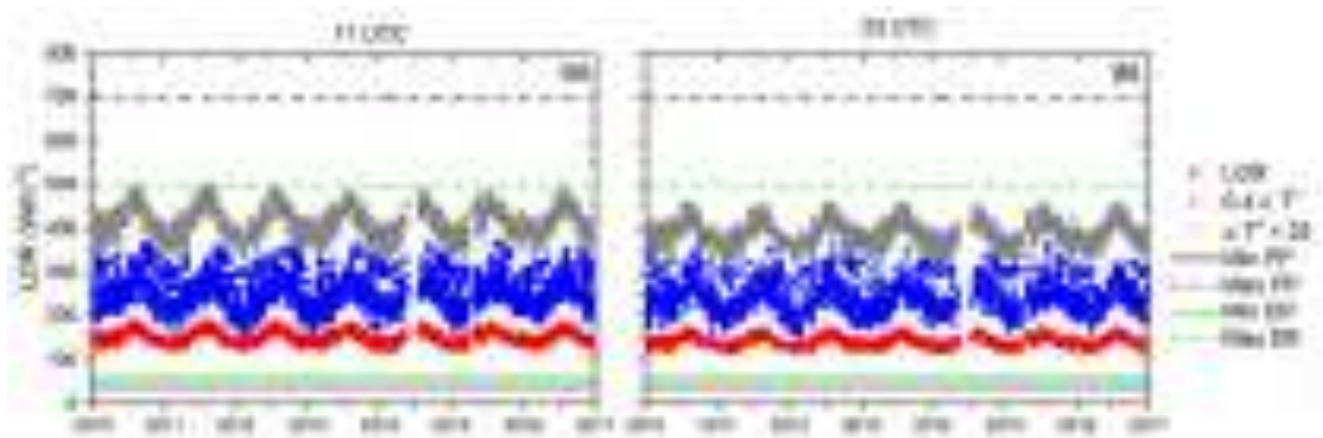

Figure 10.4. The LDR time series obtained at (a) daytime and (b) night-time with a CG4 pyrgeometer between 2010 and 2016 at IZO BSRN (blue dots). The black and green lines represent the physically possible (Min PP, Max PP) and extremely rare limits (Min ER, Max ER), respectively; the grey and red dots represent the upper ($\sigma T^4 + 25$) and lower ($0.4\sigma T^4$) limits, respectively, where σ is Stefan–Boltzmann constant ($5.67 \times 10^{-8} \text{ W m}^{-2} \text{ K}^{-4}$) and T is the air temperature in K. Reprinted from García et al. (2018).

Table 10.3. Statistics for the LDR bias between LibRadtran and MODTRAN simulations and BSRN LDR at IZO (in W m⁻²) performed with daytime (1048 cases) and night-time (1014 cases) data in the period 2010–2016 (MB, mean bias; RMS, root mean square of the bias; R²). The statistics for the relative bias are given in brackets (in %).

	Daytime			Night-time		
	MB	RMS	R ²	MB	RMS	R ²
BSRN/LibRadtran	-1.73 (-1.1%)	6.52 (2.6%)	0.970	0.15 (0.1%)	4.41 (1.8%)	0.969
BSRN/MODTRAN	-1.79 (-0.7%)	6.30 (2.5%)	0.969	1.14 (0.5%)	4.53 (1.9%)	0.968
LibRadtran/MODTRAN	0.94 (0.4%)	1.26 (0.5%)	0.999	1.00 (0.4%)	1.23 (0.5%)	0.999

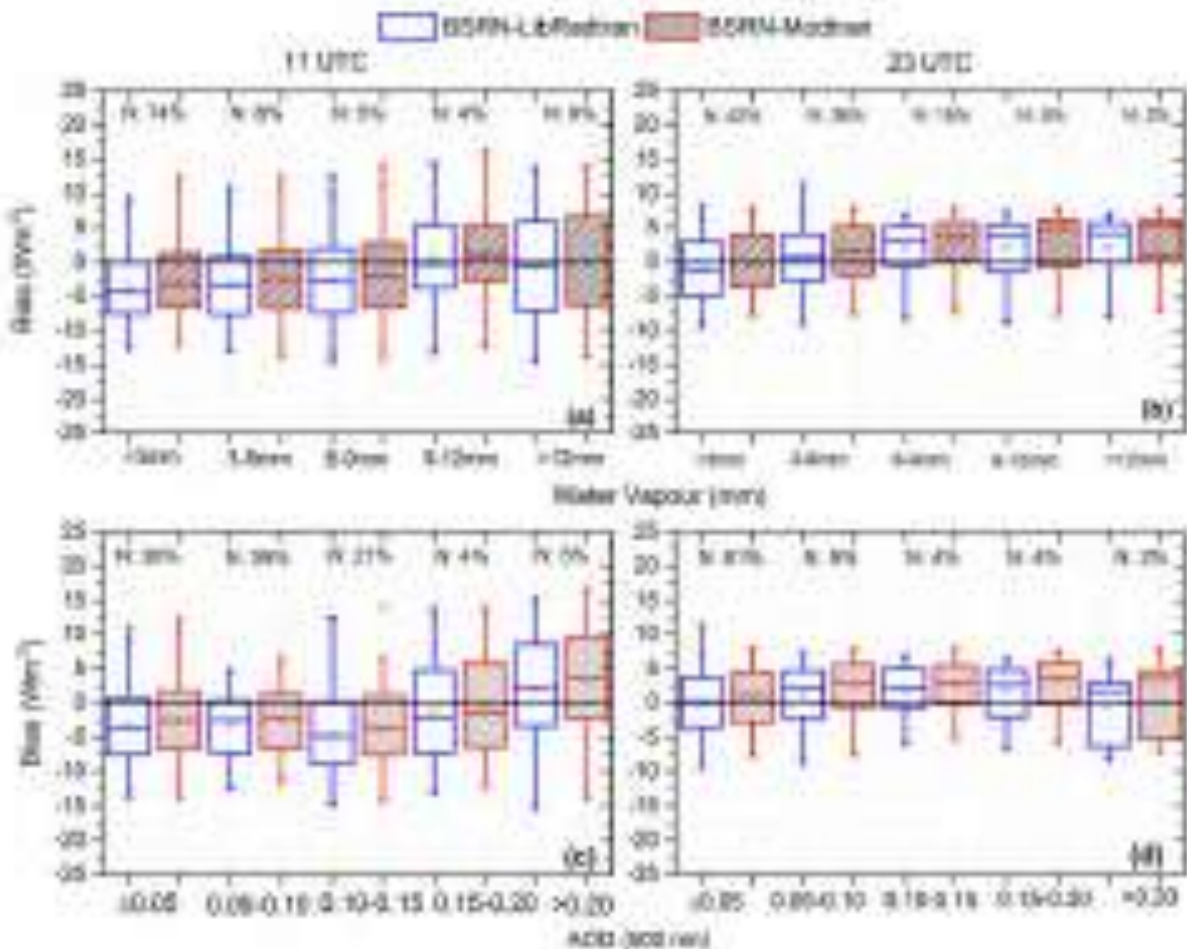

Figure 10.5. Box plot of mean LDR bias (model-BSRN in $W m^{-2}$) vs. PWV (mm) (a) at daytime (b) at night-time, and vs. AOD (500 nm) (c) at daytime and (d) at night-time between 2010 and 2016. Lower and upper boundaries for each box are the 25th and 75th percentiles; the solid line is the median value; the crosses indicate values out of the 1.5-fold box area (outliers) and hyphens are the maximum and minimum values. The blue boxes represent LibRadtran/BSRN and the red ones represent MODTRAN/BSRN. N indicates the number of measurements in each interval. Shadings show the range of instrumental error ($\pm 3 W m^{-2}$). Reprinted from García et al. (2018).

10.3.2 Description of the Baseline Surface Radiation Network (BSRN) station at the Izaña Observatory (2009-2017)

A description of the Baseline Surface Radiation Network station at the Izaña Observatory, the measurements conducted and the quality control/assurance procedures carried out was published by García et al. (2019).

As stated in Section 10.2, Izaña Observatory has been part of the BSRN since 2009. The location of the Izaña station on a global map of all BSRN stations is shown in Fig. 10.6, alongwith views of the station.

Izaña Observatory contributes with basic-BSRN radiation measurements, such as, global shortwave radiation (SWD), direct radiation (DIR), diffuse radiation (DIF) and longwave downward radiation (LWD) and extended-BSRN measurements, including ultraviolet ranges (UV-A and UV-B), shortwave upward radiation (SWU) and longwave

upward radiation (LWU) and other ancillary measurements, such as vertical profiles of temperature, humidity and wind obtained from radiosonde (WMO, station #60018) and total column ozone from Brewer spectrophotometer.

The Izaña Observatory measurements present high quality standards since more than 98 % of the data are within the limits recommended by the BSRN. There is an excellent agreement in the comparison between SWD, DIR and DIF (instantaneous and daily) measurements with simulations obtained with the LibRadtran radiative transfer model. The root mean square error (RMSE) for SWD is 2.28 % for instantaneous values and 1.58 % for daily values, while the RMSE for DIR is 2.00 % for instantaneous values and 2.07 % for daily values (Fig. 10.7). Izaña Observatory is a unique station that provides very accurate solar radiation data in very contrasting scenarios: most of the time under pristine sky conditions, and periodically under the effects of the Saharan Air Layer characterized by a high content of mineral dust.

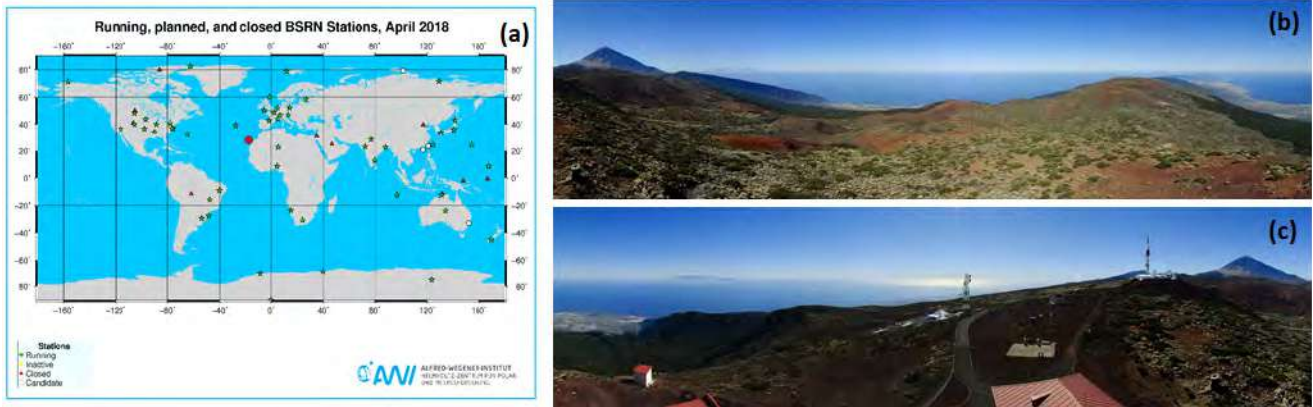

Figure 10.6. (a) Location of the Izaña station (IZA) on a global map of all BSRN stations <http://bsrn.awi.de>. Views of Izaña radiation station: (b) Northern and Eastern Views (Azimuth 360°, Inclination 0° degrees; Azimuth 90°, Inclination 0° respectively) (c) Southern and Western Views (Azimuth 180°, Inclination 0° and Azimuth 270°, Inclination 0°, respectively). Reprinted from García et al. (2019).

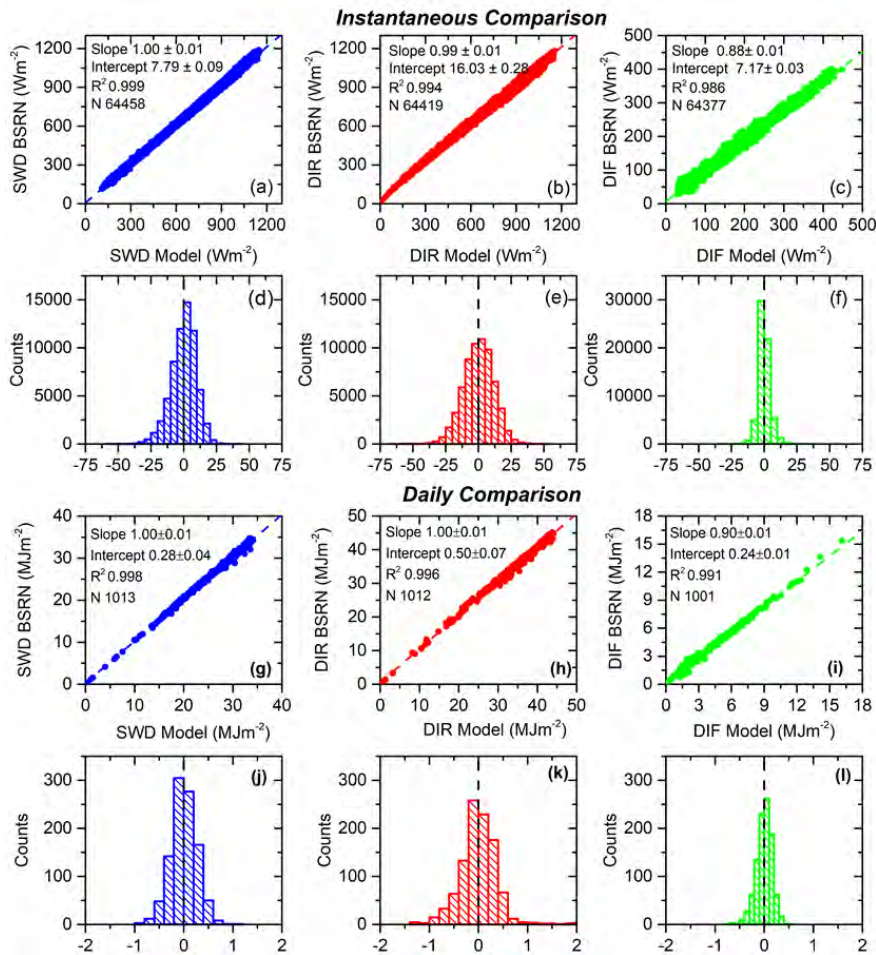

Figure 10.7. Scatterplots and histograms of the instantaneous (Wm^{-2}) and daily ($MJ m^{-2}$) radiation measurements and simulations for the period 2009–2017: (a, d, g, j) SWD, (b, e, h, k) DIR and (c, f, i, l) DIF. The fitting parameters are shown in the legend. Reprinted from García et al. (2019).

10.4 Participation in Scientific Projects and Campaigns/Experiments

10.4.1 Calibration campaign of BSRN instruments with a PMO6 Absolute Cavity Pyrheliometer

As part of the radiation quality assurance system a calibration campaign of BSRN pyranometers and pyrheliometer was performed during summers 2017 and 2018 using an Absolute Cavity Pyrheliometer PMO6 as reference (Fig. 10.8). The PMO6 was calibrated in the World Radiation Center, Davos. The BSRN instruments were calibrated following the ISO 9059:1990 (E) and ISO 9846:1993(E), delivering the corresponding official calibration certificates.



Figure 10.8. Absolute cavity radiometer (PMO6) installed at IZO during summers 2017 and 2018 in the BSRN sun-tracker.

10.5 Future activities

The main on-going and future activities of the radiation programme are focused on:

- Aerosol retrievals from spectral direct irradiance measured with the EKO MS-711 spectroradiometer. Corrections of the field of view.
- Water vapour and column ozone retrieval using the EKO MS-711 spectroradiometer.
- Reconstruction and accurate analysis of a new long-term GSR data series (since 1916) in which newly recovered observation data are being incorporated. Long-term records of aerosols (AOD), cloudiness, and solar flux will be compared with GSR data.
- Accurate determination of cloud attenuation impact on global radiation using GSR from SCO and BTO.
- Accurate analysis of UV-B broadband data from the vertical transect formed by SCO (52 m a.s.l.), IZO (2373 m a.s.l) and TPO (3555 m a.s.l.) observatories, with complementary information on cloudiness, AOD and O₃ vertical profiles (ECC O₃ sondes).

10.6 References

- Egli, L., Gröbner, J., Hülsen, G., Bachmann, L., Blumthaler, M., Dubard, J., Khazova, M., Kift, R., Hoogendijk, K., Serrano, A., Smedley, A., and Vilaplana, J.-M.: Quality assessment of solar UV irradiance measured with array spectroradiometers, *Atmos. Meas. Tech.*, 9, 1553-1567, doi:10.5194/amt-9-1553-2016, 2016.
- García, R. D., Cuevas, E., García, O. E., Cachorro, V. E., Pallé, P., Bustos, J. J., Romero-Campos, P. M., and de Frutos, A. M.: Reconstruction of global solar radiation time series from 1933 to 2013 at the Izaña Atmospheric Observatory, *Atmos. Meas. Tech.*, 7, 3139-3150, doi:10.5194/amt-7-3139-2014, 2014.
- García, R. D., Cuevas, E., García, O. E., Ramón, R., Romero-Campos, P. M., de Ory, F., Cachorro, V. E., and de Frutos, A.: Compatibility of different measurement techniques. Long-term global solar radiation observations at Izaña Observatory, *Atmos. Meas. Tech.*, 10, 731-743, doi:10.5194/amt-10-731-2017, 2017.
- García, R. D., Barreto, A., Cuevas, E., Gröbner, J., García, O. E., Gómez-Peláez, A., Romero-Campos, P. M., Redondas, A., Cachorro, V. E., and Ramos, R.: Comparison of observed and modeled cloud-free longwave downward radiation (2010–2016) at the high mountain BSRN Izaña station, *Geosci. Model Dev.*, 11, 2139-2152, <https://doi.org/10.5194/gmd-11-2139-2018>, 2018.
- García, R. D., Cuevas, E., Ramos, R., Cachorro, V. E., Redondas, A., and Moreno-Ruiz, J. A.: Description of the Baseline Surface Radiation Network (BSRN) station at the Izaña Observatory (2009–2017): measurements and quality control/assurance procedures, *Geosci. Instrum. Method. Data Syst.*, 8, 77-96, <https://doi.org/10.5194/gi-8-77-2019>, 2019.

10.7 Staff

Dr Emilio Cuevas (AEMET; Head of programme)

Dr Rosa García (AIR LIQUIDE/UVA; Co-PI)

Ramón Ramos (AEMET; Head of Infrastructure)

Dr Omaira García (AEMET; Research Scientist)

Pedro Miguel Romero (AEMET; Research Scientist)

Dr Fernando de Ory (AEMET; Meteorological Observer-GAW Technician) left IARC in October 2018

Dr Victoria Cachorro (University of Valladolid; Head of Atmospheric Optics Group)

Dr Ángel de Frutos (University of Valladolid Atmospheric Optics Group; Research Scientist)

11 Differential Optical Absorption Spectroscopy (DOAS)

11.1 Main Scientific Goals

Differential Optical Absorption Spectroscopy (DOAS) and Multi Axis Differential Optical Absorption Spectroscopy (MAXDOAS) techniques allow the determination of atmospheric trace gases present in very low concentrations. The long term monitoring of atmospheric trace gases is of a great interest for trend studies and satellite validation. The detection of gases using DOAS or MAXDOAS technique allows the study of mutual interaction between gases even when detection limits of the gases are low.

The main scientific goals of the DOAS and MAXDOAS programme are:

- To improve the knowledge of the distribution, seasonal behaviour and long term trends of minor constituents related to ozone equilibrium such as NO₂, BrO and IO and their distribution in the subtropical atmosphere.
- To obtain a climatology of stratospheric NO₂ and BrO in subtropical regions and its dependence on environmental and climatic variables.
- To study the seasonal variation of NO₂, O₃, formaldehyde (HCHO) and IO in the free troposphere and its interaction with environmental factors such as Saharan dust amongst others.
- To contribute to validation of NO₂ and Ozone satellite products (GOME, GOME2, SCIAMACHY, OMI, TROPOMI) and in the improvement of the methodology to perform such comparisons.

11.2 Measurement Programme

The DOAS technique (Platt and Stutz, 2008) is a method to determine the atmospheric trace gases column density by measuring their absorption structures in the near ultraviolet and visible spectral region.

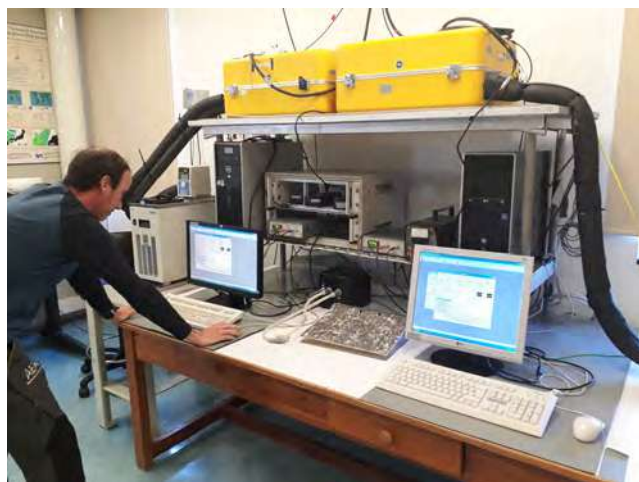

Figure 11.1. RASAS II and ARTIST II MAXDOAS (UV-VIS) spectroradiometers at IZO.



Figure 11.2. DOAS instruments outdoor optics with sky trackers.

The technique is based on measurement of atmospheric absorption of solar radiation at selected wavelength bands where the gas under consideration shows a structured and known absorption cross-section. For stratospheric observations the instrument is pointed at zenith during the twilights.

Although the DOAS technique was developed for stratospheric research, during the last few years it has been largely employed in tropospheric environment and pollution episodes studies. In particular, the so called Multi Axis Differential Optical Absorption Spectroscopy approach allows to infer vertical distribution of minor species from spectrometric measurements of solar scattered light at given angles of elevation (off-axis measurements). The analysis technique makes use of the Optical Estimation Method (Rodgers, 2000) by putting together the off-axis measurements and a radiative transfer algorithm to get the best solution for all used elevation angles.

The instruments automatically take spectra from an AM SZA = 96° to PM SZA = 96°, every day. As the instrument must work with a stabilized room temperature and also with a stabilized internal temperature and humidity, those parameters are monitored and recorded in data files. Calibration of the instrument grating is performed approximately every year. Calibration of the elevation angle is performed once a month. After the spectral inversion, a quality control of data is carried out. The acquired data are filtered on the basis of the analysis and instrumental error, aerosol optical thickness and the solar zenith angles, to ensure quality.

INTA has performed measurements of stratospheric O₃ and NO₂ at IZO since 1993. Data have been used for the study of stratospheric O₃ and NO₂ distribution in the subtropical region (Gil et al., 2012 and Yela et al., 2017) and for validation of satellite products (Hendrick et al., 2011, Robles-Gonzalez et al., 2016, Yela et al., 2017). In 2003, the installation of an ultraviolet DOAS spectrometer expanded the measurements of stratospheric gases to the near ultraviolet region, allowing the monitoring of stratospheric

BrO and the estimation of the concentration of BrO in the free troposphere. In 2010, the instruments were adapted to MAXDOAS measurements, allowing the detection of free tropospheric trace gases, such as IO and NO₂ (Puentedura et al, 2012, Gomez et al., 2014, Gil-Ojeda et al., 2015) in the visible region and of BrO and HCHO in the ultraviolet region. Prior to the installation at IZO in 2009, the VIS-MAXDOAS instrument participated in the international blind NO₂ MAXDOAS intercomparison campaign CINDI (Cabauw Intercomparison campaign Nitrogen Dioxide measuring Instrument) (Piters et al., 2012, Pinardi et al., 2013). During the AMISOC campaign in 2013, extensive measurements of IO were performed at three different altitude levels on Tenerife.

11.3 Participation in Scientific Projects and Campaigns/Experiments

11.3.1 Contribution to NDACC data Base

The Network for detection Atmospheric Composition Change (NDACC) (De Mazière et al., 2018) is one of the

most important global networks which primary goal is to establish long-term databases for detecting changes and trends in the chemical and physical state of the atmosphere and to assess the coupling of such changes with climate and air quality. INTA, with DOAS measurements of O₃ and NO₂ at IZO, contribute to NDACC since 1998. Participation in NDACC requires compliance with strict measurement and data protocols to ensure that the network data are of high and consistent quality. NO₂ and O₃ results are shown in Figures 11.3 and 11.4.

11.3.2 Contribution to CAMS27

The Copernicus Atmosphere Monitoring Service (CAMS) is an integrated service within the Copernicus program that provides information of the atmospheric composition. CAMS27 provides CAMS or high-quality atmospheric data in HDF GEOMS format within a few weeks after acquisition from selected NDACC stations, such as the DOAS measurements at IARC from INTA.

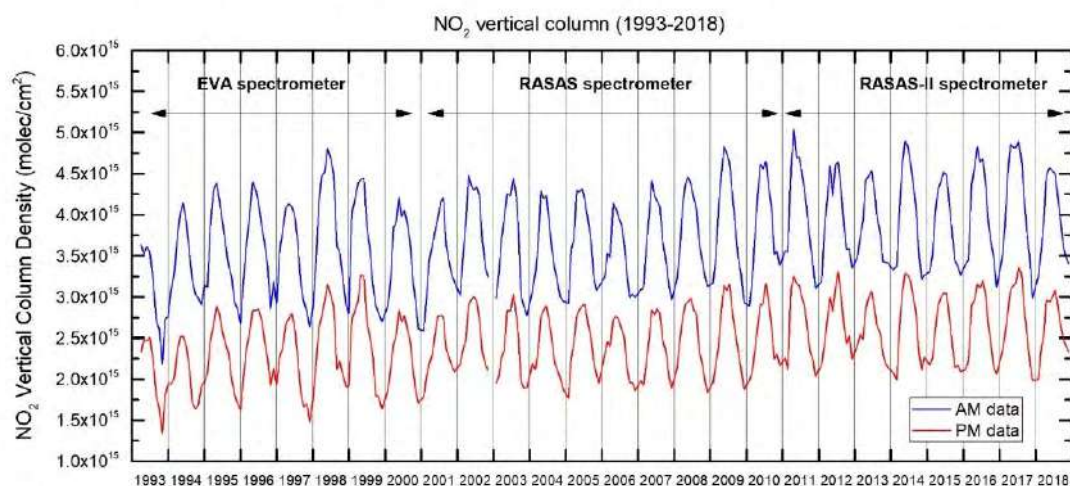

Figure 11.3. Time series of reanalyzed stratospheric NO₂ 1993-2018.

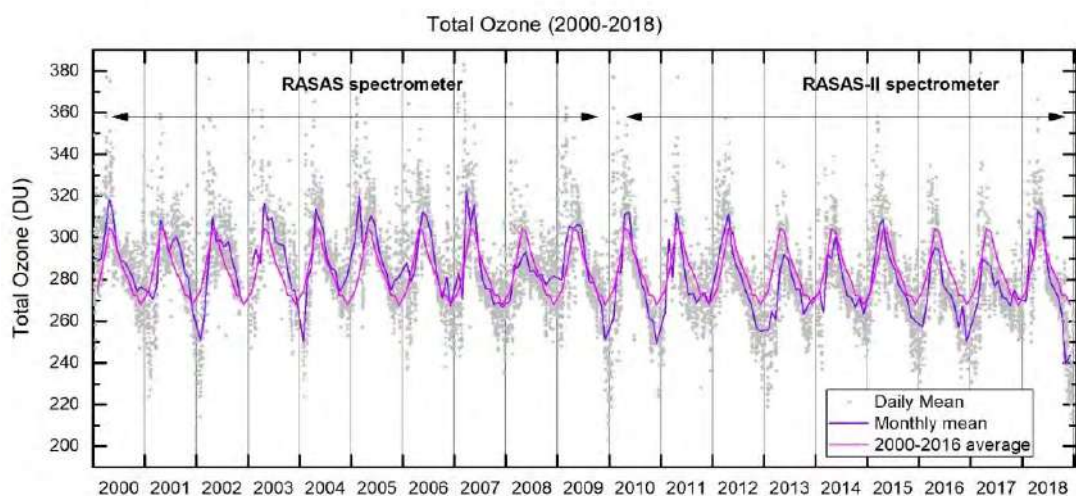

Figure 11.4. Time series of reanalyzed stratospheric O₃ 2000-2018.

11.3.3 S5P Nitrogen Dioxide and FORMaldehyde Validation (NIDFORVal) using NDACC and complementary FTIR and UV-Vis DOAS ground-based remote sensing data

This is an ESA proposal (ID28607) led by the Royal Belgian Institute for Space Aeronomy (BIRA-IASB) that started in 2016 and extends to 2024. The aim of this project is to establish a network of observations supporting validation for tropospheric products of the Sentinel-5 Precursor (Sentinel-5P). The INTA-MAXDOAS instruments installed at IARC are part of the Sentinel-5P Calibration and Validation Team for NO₂.

11.3.4 Aviation and Atmosphere: an Aerospace study on aerosols and gases (AVATAR)

AVATAR is a funded Project from the Spanish Ministry of Economy, Industry and Competitiveness (CGL2014-55230-R). This project is mainly focused on analysis of the aerosol impact on climate through the study of the gas-aerosol interaction, study of gas and aerosol distribution in airport areas, aerosol and cloud radiative effects and the performance of comparisons between satellite and ground-based measurements of aerosol.

This project is also focused on the monitoring of the free troposphere and stratosphere with the aim to extend the previous results of AMISOC of the seasonal variation of IO and BrO in the free troposphere. Activities within AVATAR have supported trace gas monitoring and NIDFORVal activities at IARC. This project is operated in collaboration with the In Situ Aerosol Programme.

11.4 Summary of remarkable results during the period 2017-2018

During years 2016 to 2018 MAXDOAS instruments have been part of the AVATAR research Project. As a continuation of previous research projects, during these years the distribution of BrO, HCHO and IO in the Free Troposphere has been investigated.

11.4.1 Measurements of Free Tropospheric IO: Seasonal evolution

The installation of Vis-MAXDOAS in 2010 allowed the detection of IO in the Free Troposphere. This was the first time that this specie was detected and measured in the free troposphere, yielding slant column densities consistent with a background concentration of 0.2-0.4 pptv in the free troposphere of marine regions and opening the question about the origin of IO in this layer (Puentedura et al., 2012). A study of the seasonal evolution of IO was undertaken during the AVATAR project during the year 2016. IO is observed during the year above the detection limit at the level of the observatory as can be seen in Fig. 11.5.

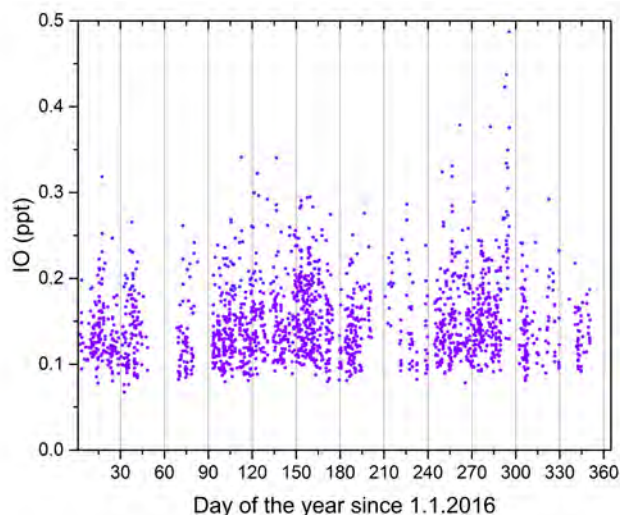

Figure 11.5. Seasonal evolution of IO in the FT during 2016.

The amount of IO varies between 0.06 and 0.55 pptv according to the limit stated by Puentedura et al. 2012. The seasonal evolution in 2016 shows a maximum in spring and autumn, although this behaviour can be modulated by meteorology, since previous studies during 2013 showed a maximum in autumn but not during the spring. This issue is currently under investigation.

11.4.2 BrO in the Free Troposphere

An attempt to determine the seasonal evolution of BrO in the FT has been carried out for the year 2016. Previous projects (AMISOC) observed a superior limit of 1 pptv at the height of the Teide volcano during the summer. During AVATAR, different seasons were explored to examine differences in the behaviour of BrO. Although BrO was detected by MAXDOAS technique during the year above the detection limit, their spectral signature cannot be confirmed, due mainly to the strong interference of HCHO, absorbing in the same spectral region. However, observations are consistent with the previous ones obtained during AMISOC.

11.4.3 Detection and seasonal evolution of HCHO in the Free Troposphere

HCHO is a trace gas included in Volatile Organic Compounds (VOCs). Its presence in the atmosphere can be due either to natural or anthropogenic emissions. One of the previous results obtained during the AMISOC project was the unexpected presence of HCHO in the FT of Tenerife in a non-negligible amount. During this project the superior limit of HCHO was estimated as 1 ppb at the height of Teide observatory. During AVATAR, a more extensive study about the behaviour of HCHO in the FT was led at IARC. The concentration of HCHO was determined for years 2016 and 2017 through MAXDOAS spectroscopy and applying Gomez et al. (2015) methodology, considering only pristine and clear days. Its seasonal evolution is displayed in Fig. 11.6. The annual cycle shows a maximum during the

summer with a mean maximum value of 289.5 ± 86.4 pptv and a minimum during the winter of 181.2 ± 74.2 pptv.

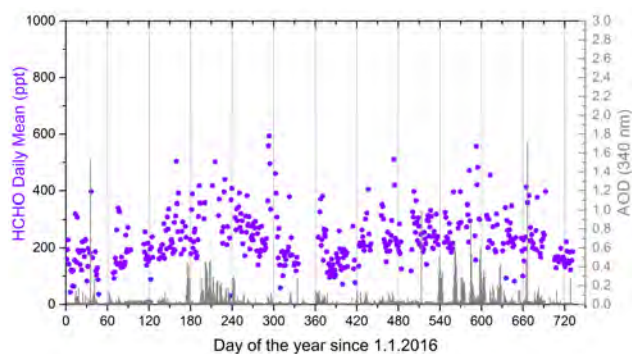

Figure 11.6. Seasonal evolution of HCHO in the FT during 2016 and 2017.

11.4.4 Hemispheric asymmetry in stratospheric NO₂ trends

The ground-based DOAS observations have a large potential for monitoring, investigating the composition of the stratosphere and for trend studies. With the refined NO₂ DOAS series obtained in four sites, we have investigated the long-term changes in the NO₂ vertical distribution (Yela et al., 2017).

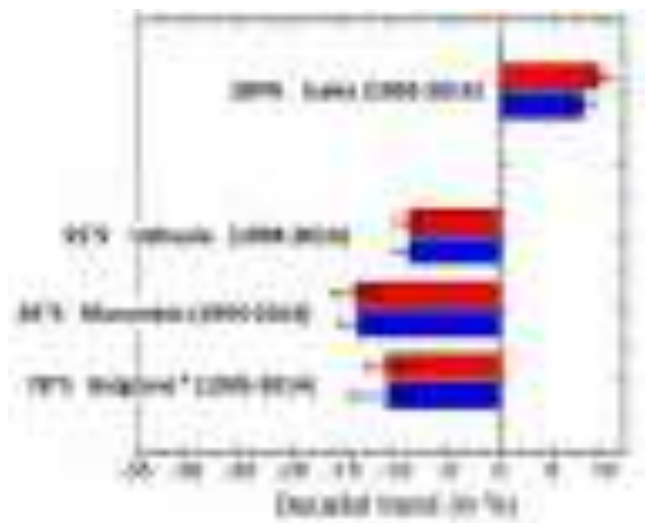

Figure 11.7. AM (red) and PM (blue) decadal trends obtained for the DOAS stations. The trend at Belgrano was obtained for the February–March–April period.

Over 20 years of stratospheric NO₂ vertical column density (VCD) data from ground-based zenith DOAS spectrometers were used for trend analysis, specifically, via multiple linear regression. Spectrometers from the NDACC cover the subtropical latitudes in the Northern Hemisphere (Izaña, 28°N), the southern Subantarctic (Ushuaia, 55°S) and Antarctica (Marambio, 64°S, and Belgrano, 78°S). The results show that for the period 1993–2014, a mean positive decadal trend of +8.7% was found in the subtropical Northern Hemisphere stations, and negative decadal trends of –8.7 and –13.8% were found in the Southern Hemisphere at Ushuaia and Marambio, respectively; all trends are

statistically significant at 95% (Fig. 11.7). Most of the trends result from variations after 2005.

The trend in the diurnal build-up per hour (DBU) was used to estimate the change in the rate of N₂O₅ conversion to NO₂ during the day. With minor differences, the results reproduce those obtained for NO₂. The trends computed for individual months show large month-to-month variability. At Izaña, the maximum occurs in December (+13.1%), dropping abruptly to lower values in the first part of the year. In the Southern Hemisphere, the polar vortex dominates the monthly distributions of the trends. The large difference in the trends at these two relatively close stations suggests a vortex shift towards the Atlantic/South American area over the past few years. The results obtained provide evidence that the NO₂ produced by N₂O decomposition is not the only cause of the observed trend in the stratosphere and support recent publications pointing to a dynamical redistribution starting in the past decade.

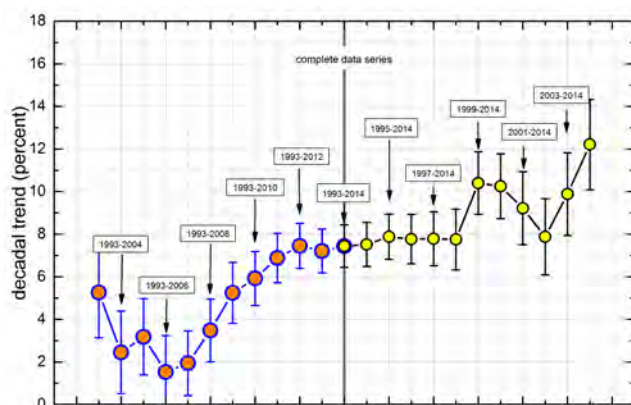

Figure 11.8. Dependency of the Izaña PM trend on the selected period. In the central point, the complete 1993–2014 time series is used. Each point to the left (orange circles) is the trend after reducing the time series by 1 year before 2014. Each point to the right (yellow circles) is the trend after reducing the time series by 1 year after 1993.

We explored the trend sensitivity to the data series length by reducing the period at both the starting and ending months. For this exercise, we chose the Izaña PM series. The results (Fig. 11.8) show that the trend remains essentially unchanged if the data series is shortened by up to five years at the start and up to four at the end, providing confidence in the stability of the trend. It can also be seen that the trend is largest during the last decade (2004–2014).

11.5 References

De Mazière, M., Thompson, A. M., Kurylo, M. J., Wild, J. D., Bernhard, G., Blumenstock, T., Braathen, G. O., Hannigan, J. W., Lambert, J.-C., Leblanc, T., McGee, T. J., Nedoluha, G., Petropavlovskikh, I., Seckmeyer, G., Simon, P. C., Steinbrecht, W., and Strahan, S. E.: The Network for the Detection of Atmospheric Composition Change (NDACC): history, status and perspectives, *Atmos. Chem. Phys.*, 18, 4935–4964, <https://doi.org/10.5194/acp-18-4935-2018>, 2018.

- Gil-Ojeda, M., M. Navarro-Comas, A. Redondas, O. Puentedura, F. Hendrick, M. Van Roozendaal, J. Iglesias and E. Cuevas. Total ozone measurements from the NDACC Izaña Subtropical Station: Visible spectroscopy versus Brewer and satellite instruments. Quadrennial Ozone Symposium, (QOS 2012). Toronto, Canada. 27-31 August 2012.
- Gil-Ojeda, M. Navarro-Comas, L. Gómez-Martín, J. A. Adame, A. Saiz-Lopez, C. A. Cuevas, Y. González, O. Puentedura, E. Cuevas, J.-F. Lamarque, D. Kinnison, S. Tilmes, NO₂ seasonal evolution in the north subtropical free troposphere, *Atmos. Chem. Phys.*, 15, pp. 10569-10579, doi:10.5194/acp-15-10567-2015, 2015
- Gil, M., M. Yela, L. N. Gunn, A. Richter, I. Alonso, M. P. Chipperfield, E. Cuevas, J. Iglesias, M. Navarro, O. Puentedura, and S. Rodriguez, NO₂ climatology in the northern subtropical region: diurnal, seasonal and interannual variability *Atmos. Chem. Phys.* 8, 1635–1648, 2008.
- Gomez, L., Navarro-Comas, M., Puentedura, O., Gonzalez, Y., Cuevas, E., and Gil-Ojeda, M.: Long-path averaged mixing ratios of O₃ and NO₂ in the free troposphere from mountain MAX-DOAS, *Atmos. Meas. Tech.*, 7, 3373-3386, doi:10.5194/amt-7-3373-2014, 2014.
- Hendrick, F., J.-P. Pommereau, F. Goutail, R. D. Evans, D. Ionov, A. Pazmino, E. Kyrö, G. Held, P. Eriksen, V. Dorokhov, M. Gil, and M. Van Roozendaal, NDACC/SAOZ UV-visible total ozone measurements: improved retrieval and comparison with correlative ground-based and satellite observations, *Atmos. Chem. Phys.*, 11, 5975-5995, 2011.
- Pinardi, G., Van Roozendaal, M., Abuhassan, N., Adams, C., Cede, A., Clémer, K., Fayt, C., Frieß, U., Gil, M., Herman, J., Hermans, C., Hendrick, F., Irie, H., Merlaud, A., Navarro Comas, M., Peters, E., PETERS, A. J. M., Puentedura, O., Richter, A., Schönhardt, A., Shaiganfar, R., Spinei, E., Strong, K., Takashima, H., Vrekoussis, M., Wagner, T., Wittrock, F., and Yilmaz, S.: Erratum: MAX-DOAS formaldehyde slant column measurements during CINDI: intercomparison and analysis improvement (*Atmospheric Measurement Techniques* (2013) 6 (167-185)), *Atmos. Meas. Tech.*, 6 (2), 219, doi: 10.5194/amt-6-219-2013, 2013.
- Piters, A. et al.: The Cabauw Intercomparison campaign for Nitrogen Dioxide measuring Instruments (CINDI): design, execution, and early results, *Atmos. Meas. Tech.*, 5, 457-485, doi:10.5194/amt-5-457-2012, 2012.
- Platt and Stutz, *Differential Optical Absorption Spectroscopy, Principles and Applications*, Springer, 2008.
- Puentedura, O., Gil, M., Saiz-Lopez, A., Hay, T., Navarro-Comas, M., Gómez-Pelaez, A., Cuevas, E., Iglesias, J., and Gomez, L.: Iodine monoxide in the north subtropical free troposphere, *Atmos. Chem. Phys.*, 12, 4909-4921, doi:10.5194/acp-12-4909-2012, 2012.
- Robles-Gonzalez, C., Navarro-Comas, M., Puentedura, O., Schneider, M., Hase, F., Garcia, O., Blumenstock, T., and Gil-Ojeda, M.: Intercomparison of stratospheric nitrogen dioxide columns retrieved from ground-based DOAS and FTIR and satellite DOAS instruments over the subtropical Izaña station, *Atmos. Meas. Tech.*, 9, 4471-4485, doi:10.5194/amt-9-4471-2016, 2016.
- Rodgers, C.D., *Inverse methods for Atmospheric Sounding: Theory and Practice*, World Scientific, Series on Atmospheric, Oceanic and Planetary Physics, Vol. 2, 2000.
- Yela, M., Gil-Ojeda, M., Navarro-Comas, M., Gonzalez-Bartolomé, D., Puentedura, O., Funke, B., Iglesias, J., Rodríguez, S., García, O., Ochoa, H., and Deferrari, G.: Hemispheric asymmetry in stratospheric NO₂ trends, *Atmos. Chem. Phys.*, 17, 13373-13389, https://doi.org/10.5194/acp-17-13373-2017, 2017.

11.6 Staff

The DOAS research group is composed of researchers and specialist technicians from INTA and IARC-AEMET.

Dr Margarita Yela González (INTA; Head of programme)

Dr Olga Puentedura Rodríguez (INTA; Research Scientist)

Dr Mónica Navarro Comas (INTA; Research Scientist)

Javier Iglesias Méndez, (INTA; Research Scientist)

Dr Laura Gómez Martín (INTA; Research Scientist)

Ramón Ramos (AEMET; Head of Infrastructure)

12 Water Vapour

12.1 Main Scientific Goals

The main scientific goals of this programme are:

- High quality observations and study of precipitable water vapour (PWV) total column content and vertical profile.
- Analysis of intra-hourly variability as well as daily and annual mean cycles of PWV for different locations and altitudes of Tenerife and La Palma islands.
- Study of radiative forcing due to water vapour and clouds.
- Study of monthly and annual mean series, analyzing their homogeneity and evaluating their anomalies and evolution over time to detect possible trends.

12.2 Measurement Programme

Several measurement techniques are used in this programme.

12.2.1 RS-92 and RS-40 Vaisala radiosondes

From the vertical profiles of relative humidity obtained with RS-92 radiosondes, precipitable water content in the atmospheric column is calculated by integrating numerically (using the trapezoidal rule) the density function of atmospheric water vapour for the base and top of each atmospheric stratum. The integration is performed from ground level to 12 km altitude. By default, the PWV profile is supplied for the following layers: 1) from ground up to 1.5 km; 2) from 1.5 km to 3 km altitude in layers of 0.5 km thickness; 3) from 3 km altitude up to 12 km in layers of 1 km thickness.

From 13 December 2017, the RS-92 radiosondes have been replaced by RS-40 Vaisala radiosondes. The RS-40 radiosonde has a higher temporal resolution (1s) compared to the RS-92 radiosonde (2s), this results in a greater number of levels in the vertical profiles for pressure, temperature and humidity. However, at high altitudes (~14 km in the stratosphere), we have frequently detected a weak decrease in altitude in the RS-40 Vaisala Tenerife radiosonde data. It could be due to the combination between an excessively high temporal resolution and longer response times and errors of the different meteorological sensors and GNSS. For these reasons, those records are filtered from the files before they are evaluated.

At the moment, no individual corrections are being applied to the RS-92 radiosonde data in order to correct for possible inhomogeneities with respect to the RS-40 radiosonde data. Instead, we will analyze the homogeneity of the monthly mean series for the total PWV column and, if necessary, homogenize them by adjusting the medians on the possible breakpoints.

12.2.2 Radiometric technique

Precipitable total water content in the atmospheric column is estimated from the absorption of water vapour in a narrow band around 941 nm from a MFRSR (Yankee Environmental Systems, Model MFR-7). From the PWV value deduced from RS92, we can characterize, on the one hand, the filter parameters of the water vapour channel using the Campanelli technique (Campanelli et al, 2010; Romero-Campos et al., 2011a), and on the other hand, through the Langley-modified technique, we can obtain the extraterrestrial irradiances for 941 nm, from which we extract the corresponding calibration constant. Finally, 1-minute PWV is obtained.

From 1996 to 2004, the MFRSR has been the radiometer used to evaluate the PWV at Izaña Observatory. Since 2004, more precise measurements of PWV have been carried out by AERONET-Cimel Network sunphotometers but with a lower temporal resolution. On 30 January 2019, the stepper motor of MFRSR was damaged and we are currently waiting for the replacement.

12.2.3 Global Navigation Satellite System technique

The Global Navigation Satellite System (GNSS) technique consists in determination of PWV in the atmospheric column from the observed delay in radio signals at two different frequencies emitted by a network of Global Positioning System (GPS) and Global Navigation Satellite System (GLONASS) satellites received in our GNSS receiver (Fig. 12.1).



Figure 12.1. Global Navigation Satellite System receiver at Izaña Atmospheric Observatory.

Currently, we work with nine GNSS receiver stations (Fig. 12.2) at different heights, eight of them in Tenerife and one in La Palma island. The atmospheric pressure in places where the GNSS antennas are located is a key parameter for obtaining the PWV from the zenith total delay (ZTD) and zenith hydrostatic delay (ZHD).

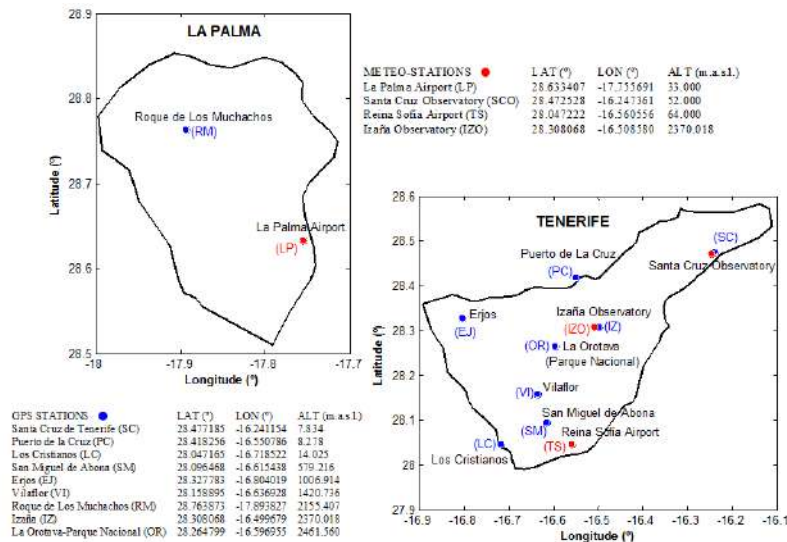

Figure 12.2. Locations of Global Navigation Satellite System stations.

The four reference meteorological stations used to obtain accurate surface pressure records with GNSS stations are: Reina Sofia Airport-Tenerife South, IZO, SCO and La Palma Airport. The GNSS network and data acquisition are managed by the Spanish National Geographic Institute (IGN).

The PWV is calculated from ZTD and pressure values at the stations. An important task we do is estimate the pressure in the GNSS sites where measurements of surface pressure are not available. To do this, we calculate, based on the hydrostatic equation, a mean density (weighted by gravity) of the air in the air column between the nearest reference weather stations and our GNSS station located at different altitude on the field.

The final evaluation of the PWV obtained by the three techniques described above is performed by comparing the results with each other. At IZO these techniques have been evaluated using the FTIR as reference instrument. A detailed analysis is provided in Schneider et al. (2010).

12.2.4 Microwave Radiometer: a new acquisition

During 2019, the reception of a high-precision microwave radiometer for continuous atmospheric profiling is planned. The acquired model is the RPG-LHATPRO-G5 series of Radiometer Physics Rohde & Schwarz Company which will allow us to obtain tropospheric temperature and humidity vertical profiles with a vertical spatial resolution of 200 m to 400 m, depending on the altitude level, and a temporal resolution of 1 second. The radiometer will be installed at IZO and it is especially designed to measure at low humidity. It works with two channels: 60 GHz oxygen absorption line for temperature profiling and 183 GHz water vapour line to obtain humidity and water vapour profiles from the brightness temperature measurement using an Artificial Neural Network (ANN) algorithm.

12.3 Summary of remarkable results during the period 2017-2018

12.3.1 Hourly variability of PWV from GNSS

Hourly variability of PWV is defined as the dispersion from the hourly mean value. From ultra rapid GNSS orbits, PWV values are calculated each 15 minutes. During an hour, a total of 5 values are obtained: 4 values + 1 additional one corresponding to the 59th second. The hourly means have been calculated with a minimum of 3 hourly values (60%). The dispersion can be measured in several ways, by hourly standard deviations, hourly ranges or percentages of both (Table 12.1).

Table 12.1. Hourly PWV variability at Izaña Observatory (2008-2018) from GNSS.

Hourly PWV variability at IZO: 2008-2018	
M(Hstd)	0.14 mm (0.14 mm)
M(Hstdp)	4.65% (4.66%)
M(Hran)	0.35 mm (0.34 mm)
M(Hranp)	11.12% (11.15%)

Values obtained without outliers are given in brackets.

Hmean are the hourly means. Hstd are the hourly standard deviations from the hourly means. M(Hstd) is the mean value for the whole period 2008-2018 from the hourly standard deviations from the hourly means.

Hstdp = Hstd/(Hmean)*100 are the percentages of hourly standard deviations from the hourly means. M(Hstdp) is the mean value for the whole period 2008-2018 from the percentages of hourly standard deviations from the hourly means.

Hran are the hourly ranges = $\max(\text{Hourly PWV}) - \min(\text{Hourly PWV})$. $M(\text{Hran})$ = is the mean value for the whole period 2008-2018 from the hourly ranges.

$\text{Hranp} = \text{Hran}/\text{Hmean} * 100$ are the percentages of hourly ranges from the hourly means. $M(\text{Hranp})$ = is the mean value for the whole period 2008-2018 from the percentages of hourly ranges.

We apply the Tukey fences as criteria to test for possible outliers. In our Hmean series, we consider outliers when the hourly mean value is outside of the interval:

$$[Q1 - 3 * \text{irq}, Q3 + 3 * \text{irq}],$$

where Q1 and Q3 are the 25th and 75th percentiles of the Hmean values, respectively, and irq is the interquartile range: $\text{irq} = Q3 - Q1$.

For the whole period 2008-2018 there are 264 outliers. The minimum outlier is 20.60 mm.

The dependency of the hourly standard deviation and hourly range with respect to the GNSS-PWV hourly mean at Izaña Observatory during 2008-2018 is shown in Figure 12.3.

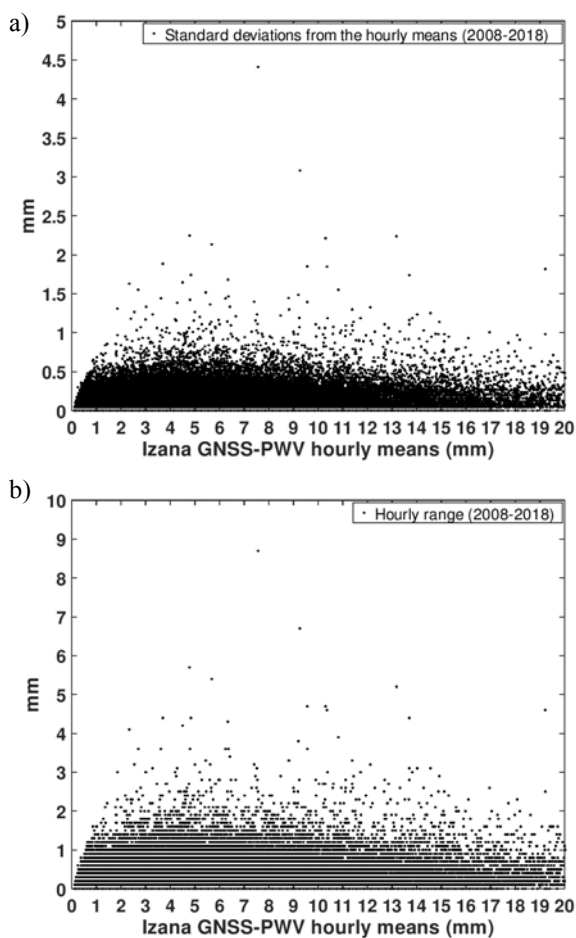

Figure 12.3. a) Dependency of the hourly standard deviation and b) hourly range with respect to the GNSS-PWV hourly mean at IZO during 2008-2018.

Table 12.2. Hourly PWV variability at Santa Cruz Observatory (2008-2018) from GNSS.

Hourly PWV variability at SCO: 2008-2018	
M(Hstd)	0.20 mm (0.20 mm)
M(Hstdp)	1.05% (1.05%)
M(Hran)	0.50 mm (0.50 mm)
M(Hranp)	2.56% (2.57%)

Values obtained without outliers are given in brackets.

At SCO for the whole period 2008-2018, there are 111 outliers. The minimum outlier is 48.4 mm. The dependency of the hourly standard deviation and hourly range with respect to the GNSS-PWV hourly mean at Santa Cruz Observatory during 2008-2018 is shown in Figure 12.4.

In summary, 1-hour is a reasonable time interval in which the PWV could be considered as a constant, both at the surface (SCO) and in the free troposphere (IZO) since most of its variation falls within the measurement error of $\pm 3.5\text{mm}$ (Schneider et al., 2010).

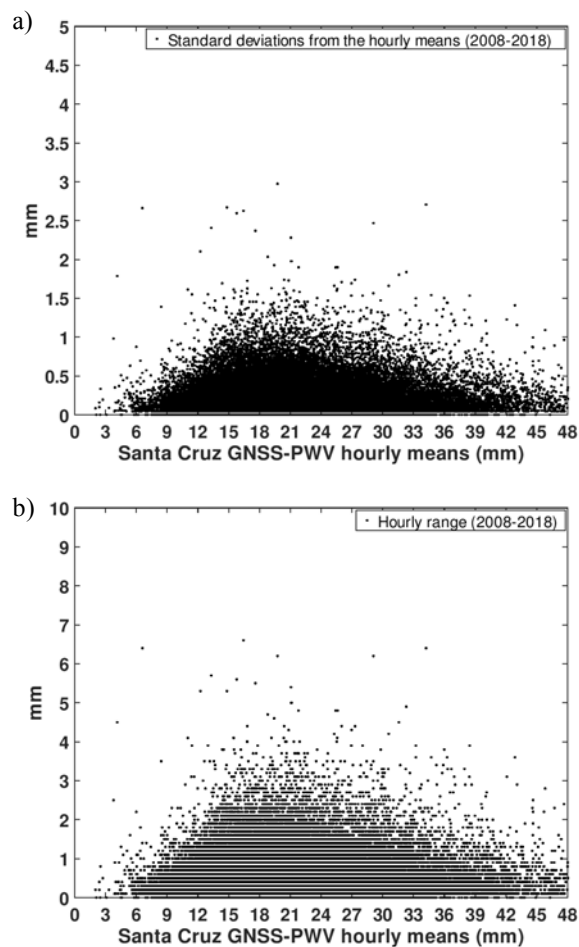

Figure 12.4. a) Dependency of the hourly standard deviation and b) hourly range with respect to the GNSS-PWV hourly mean at SCO during 2008-2018.

12.3.2 Daily mean cycle of PWV from GNSS

The averaged daily cycles of PWV for the period 2008-2018 are shown for GNSS stations at SCO and at IZO (Fig. 12.5). The daily cycles have been calculated from averaged hourly anomalies. For these statistics, we have selected only those hourly average values with, at least 60% of high quality intra-hours values, on days with at least 15 hourly means (60%). The daily time anomalies were obtained by subtracting from the value of the corresponding hourly average, the value of the daily average. Then, for each hour, the averages for all of the available data anomalies within the time period of evaluation are calculated. The diurnal variations are quite similar at IZO and SCO, which suggests a synoptic cause (non-local type), with a minimum observed at around 10UTC at these stations and a maximum around 18UTC and 17UTC at SCO and IZO, respectively.

The daily mean cycles for PWV, temperature and pressure at Santa Cruz and Izaña, are shown in Fig. 12.6. There is an anti-correlation between the daily evolution of pressure and PWV both during the night-time and daytime. We observe a delay on the correlation between temperature and PWV since PWV reaches its maximum daily value about 17UTC-18UTC, 3 hours later than the time at which the maximum daily temperature is reached (~about 14UTC-15UTC).

Atmospheric pressure plays a more important role in determination of PWV than temperature. An uncertainty of 1 hPa in pressure produces, approximately, the same uncertainty in determination of PWV (0.33 mm-0.36 mm) as an uncertainty of 5K in temperature (Hagemann et al., 2003).

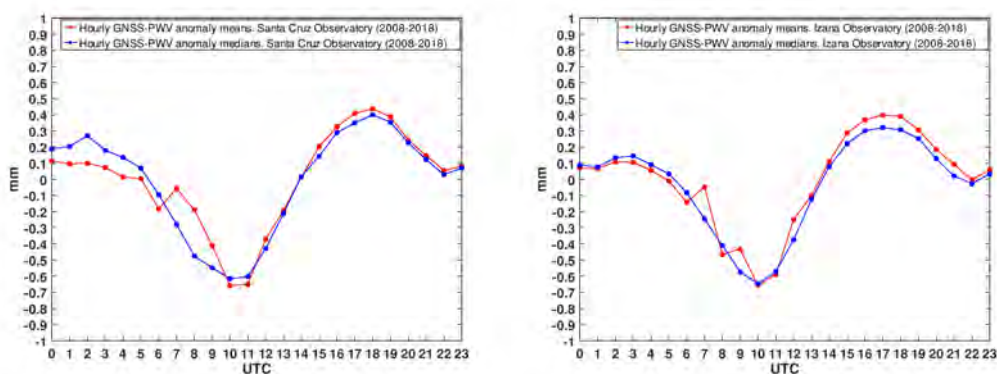

Figure 12.5. PWV daily mean cycle at SCO (left) and IZO (right) from GNSS for 2008-2018.

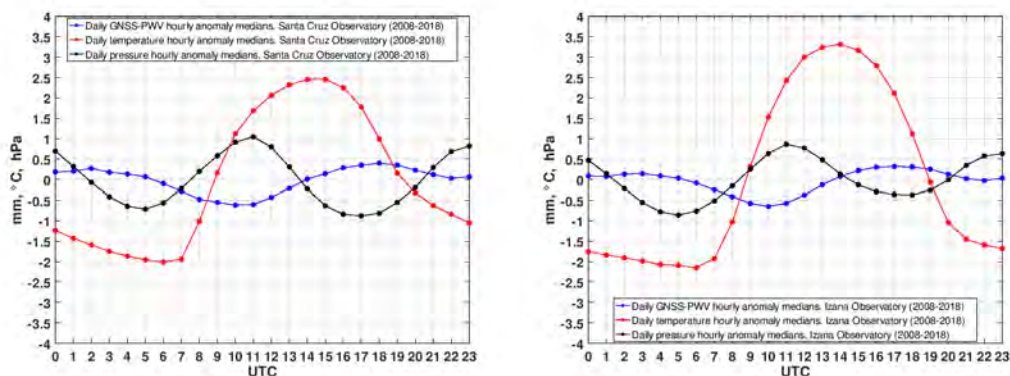

Figure 12.6. Daily mean cycle for temperature, pressure and PWV at SCO (left) and IZO (right) for 2008–2016.

12.3.3 Monthly mean PWV data series from GNSS

Following a similar procedure to that of other authors (Botey et al., 2013), monthly PWV data series were calculated from daily mean PWV by averaging within the months in which we have, at least, 18 (60%) of all possible daily data. These averaged monthly data series are shown for the period 2008-2018 for SCO (Fig. 12.7) and for IZO (Fig. 12.8).

However, the monthly series for SCO and IZO had some gaps. To fill these monthly gaps we proceed as follows. Firstly, we evaluate the monthly anomalies subtracting from the monthly means the annual mean cycle (see next section). Then we interpolated linearly the gaps in the anomalies and finally, we added the annual mean cycle again.

Applying the Wilcoxon-Mann-Whitney iterative test (Lanzante, 1996) as described in (Romero-Campos, P.M. et al., 2011), using 99% confidence interval, no inhomogeneity was detected at SCO or IZO for either of the two series: original with gaps and filled without gaps.

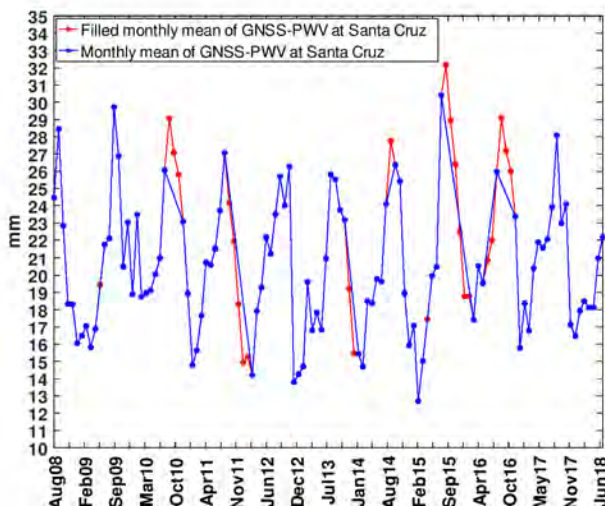

Figure 12.7. PWV monthly data series at SCO (2008-2018).

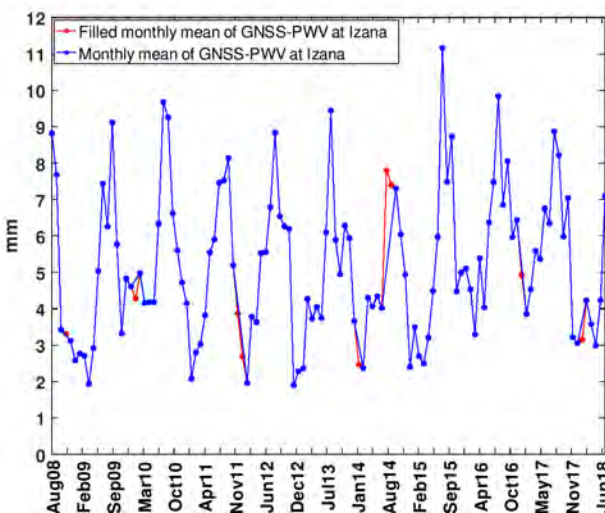

Figure 12.8 PWV monthly data series at IZO (2008-2018).

12.3.4 Annual mean cycle of PWV from GNSS

The PWV annual mean cycles for SCO and IZO for the 2008-2018 period are shown in Fig. 12.9 and Fig. 12.10, respectively. The maximum value for the annual mean cycle in Santa Cruz is produced at the end of the summer (September), this shows a one month delay with respect to Izaña, which reaches its maximum value in August.

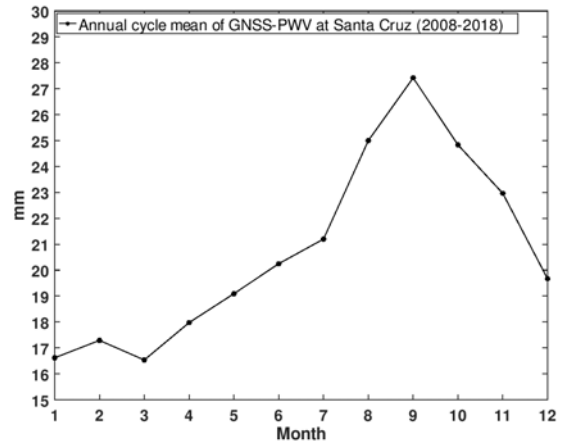

Figure 12.9. GNSS PWV annual mean cycle, SCO (2008-2018).

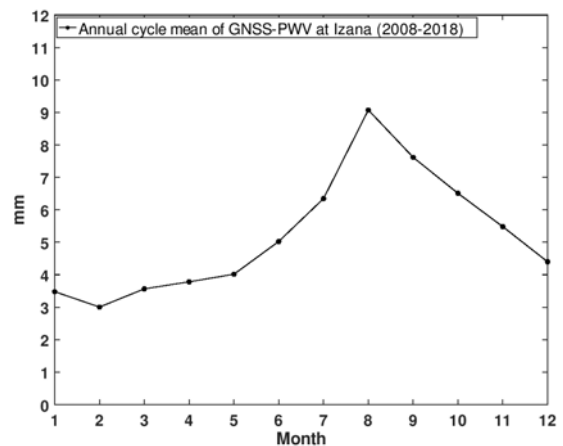

Figure 12.10. GNSS PWV annual mean cycle, IZO (2008-2018).

12.3.5 Monthly mean PWV from radiosondes at Tenerife

Relatively long monthly mean PWV data series are available from the radiosondes launched on Tenerife. PWV obtained from radiosondes at SCO and IZO are shown for the period 1995-2018 (Fig. 12.11).

These are the values of PWV calculated over the duration of the radiosonde flight (about 2 hours or so) from the time of its release, and assuming that, in this period of time, the PWV remains constant. We can observe annual cycles with peaks in summer-autumn and minimum values in winter. Lower values of PWV are observed at IZO in comparison with SCO.

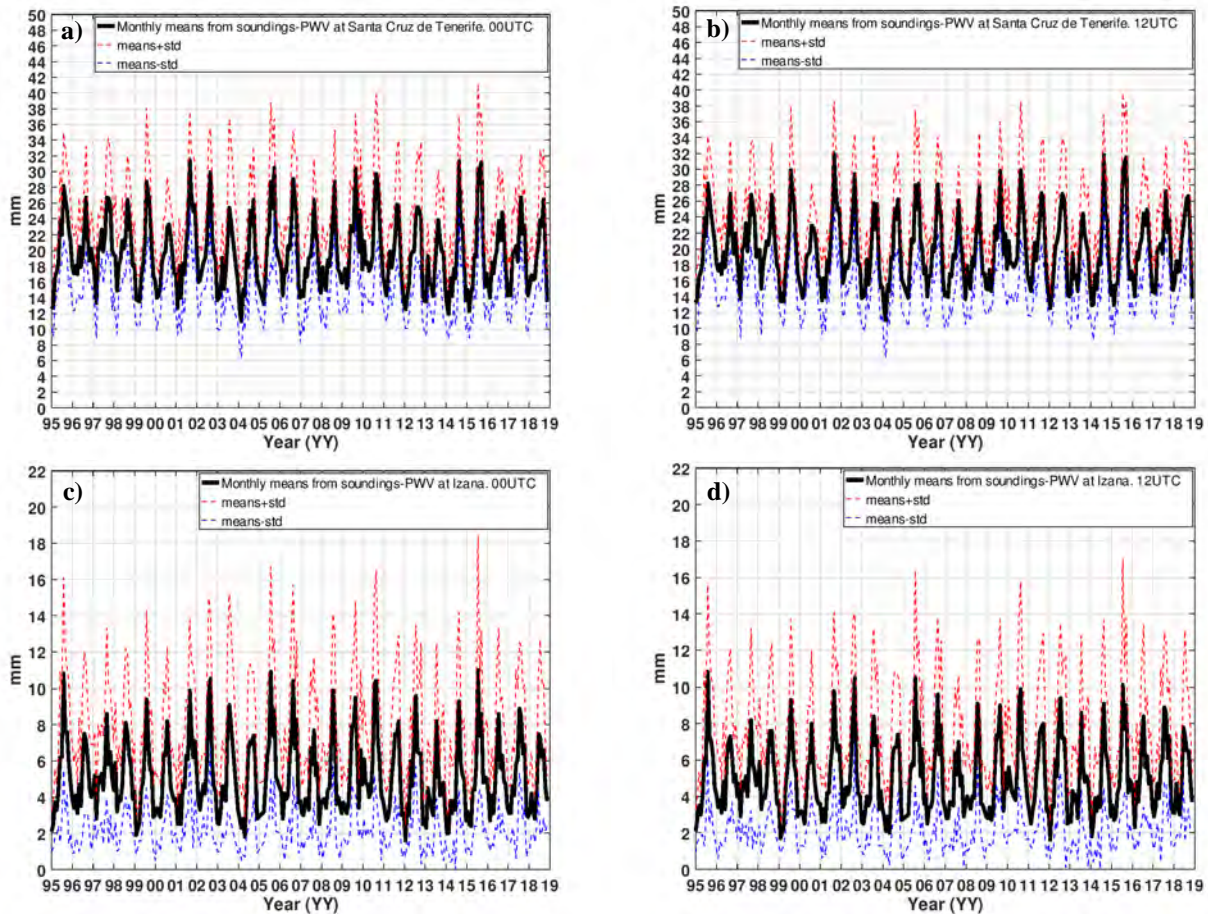

Figure 12.11. Daily PWV series from Tenerife radiosondes for SCO a) 00UTC, b) 12UTC and IZO c) 00UTC and d) 12UTC (1995–2018).

12.3.6 PWV vertical stratification monthly statistics

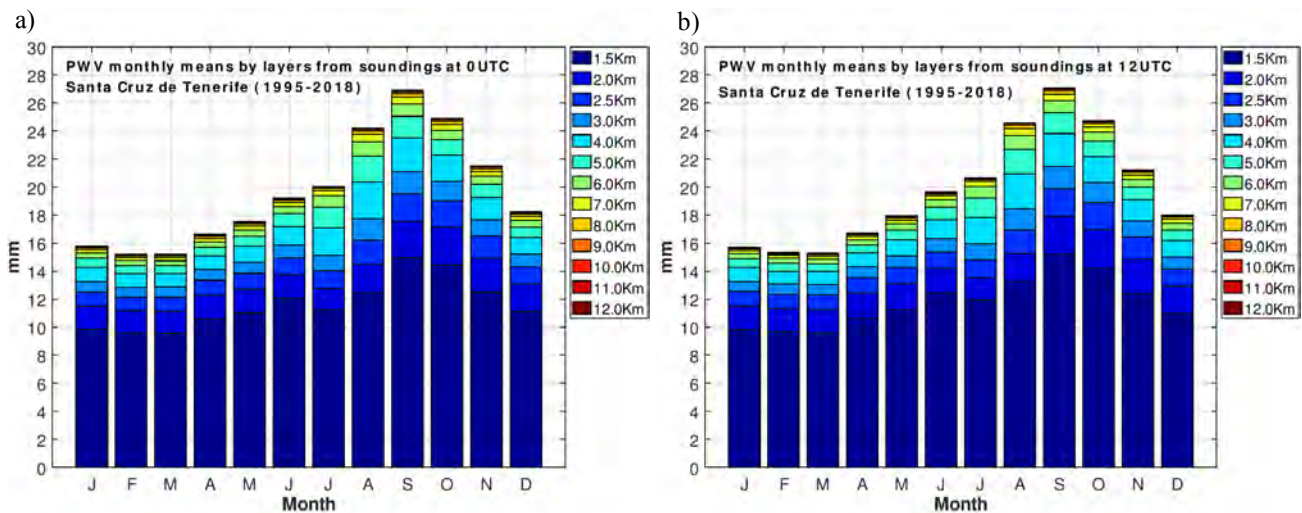

Figure 12.12. Monthly statistics of precipitable water vapour vertical distribution from Tenerife radiosondes: a) 00UTC and b) 12UTC, (1995-2018).

The monthly average of PWV vertical distribution over Tenerife, obtained from radiosondes data at 0 and 12UTC in the period 1995-2018, are depicted in Fig. 12.12. No significant differences are found between 00 and 12UTC. The total height of each column corresponds to the total monthly averaged PWV at sea level.

Most of the PWV is concentrated within the first 1.5 km altitude. There is a wet season from August to October, with a maximum in September (~27 mm), and a "dry" season that corresponds to the months from January to April with a minimum in February-March (~15 mm).

12.3.7 Evolution of annual and seasonal PWV from soundings at Tenerife

The evolution of PWV annual means (Fig. 12.13) demonstrates periods of different duration in which high and low values for PWV are alternating. There are “wet” and “dry” periods with values of PWV above or under the total mean for the whole period (1995-2018), respectively. Also, we can see larger amplitude oscillations in the period 2000-2010.

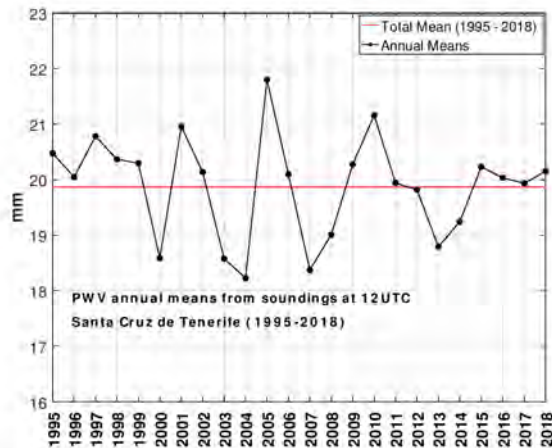

Figure 12.13. PWV annual means from Tenerife radiosondes, 1995-2018, compared to 1995-2018 average.

In the evolution of PWV seasonal means (Fig. 12.14) we observe that Spring is the only season which, for the period 2000-2010, shows annual season means below the total seasonal mean for the whole period (1995-2018).



Figure 12.14. PWV seasonal means from Tenerife radiosondes, 1995-2018, compared to 1995-2018 seasonal averages.

12.3.8 Relationship between mixing ratio and AOD over Tenerife

Mixing ratio (MR) for water vapour is defined as the mass of water vapour contained in the total mass of the dry air. We analysed the mean monthly profiles of the water vapour mixing ratio obtained from soundings over Tenerife and we observe two typical patterns. The first pattern corresponds to clean or pristine atmospheres (AOD-500 nm < 0.03), this is the more common event in the free troposphere over Izaña during most of the year (Fig. 12.15).

The second typical pattern occurs when there are Saharan desert outbreaks at high altitudes over Izaña Observatory, especially during the July and August months carrying water vapour and contributing to the increase of mixing ratio (Fig. 12.16). The air mass crosses the ocean at low levels when it leaves the African continent and the water vapour is adhered to the particles. Subsequently, the air mass rises to levels above 2000 m in the free troposphere.

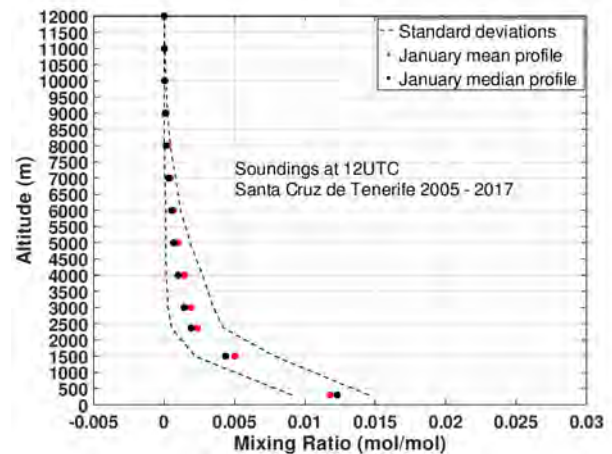

Figure 12.15. January mean and median water vapour vertical profile from Tenerife radiosondes, 2005-2017.

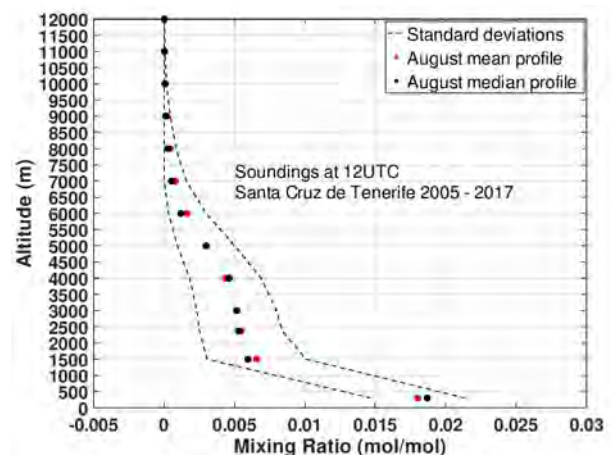

Figure 12.16. August mean and median water vapour vertical profile from Tenerife radiosondes, 2005-2017.

We obtain an estimation of the influence of the Saharan outbreaks on the contribution of water vapour to the atmospheric column by subtracting from the mixing ratio means at each level for July and August the corresponding

mixing ratio means for a profile in which the days with high AOD have been removed previously.

In general, considering AOD-500nm as a reference of the aerosols load in the atmosphere, we observe in Figures 12.17 and 12.18, the influence of AOD on water vapour mixing ratio at low and high altitudes.

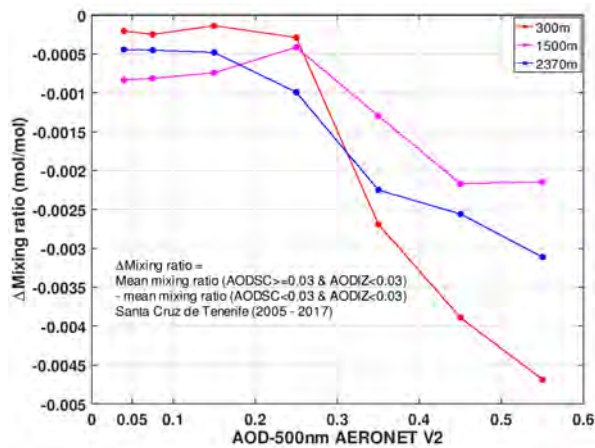

Figure 12.17. Change in water vapour mixing ratio versus AOD for 300 m to 2370 m.

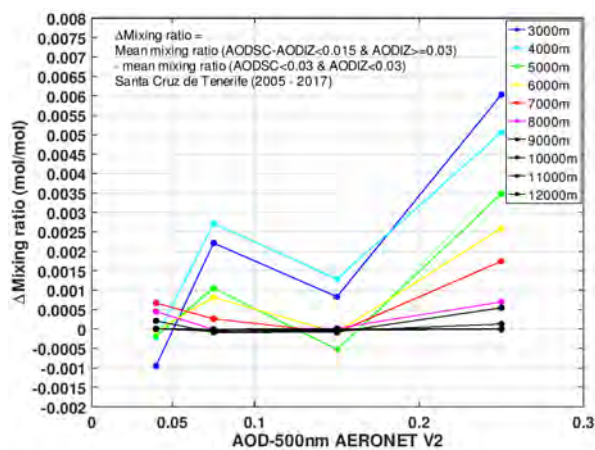

Figure 12.18. Change in water vapour mixing ratio versus AOD for 3000 m to 12000 m.

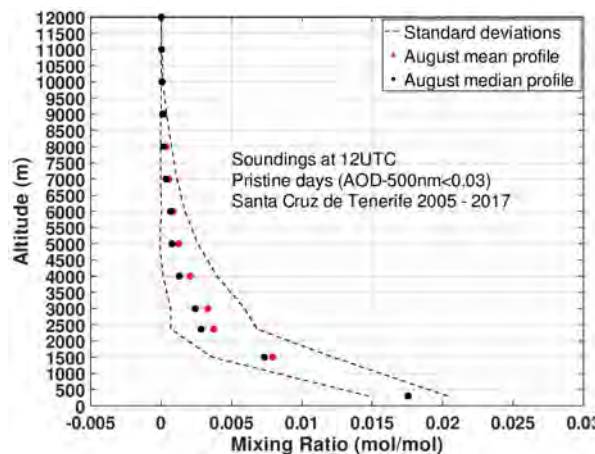

Figure 12.19. August mean and median water vapour vertical profile from Tenerife radiosondes for pristine days only, 2005-2017.

When we remove from the vertical profiles those days which dust load has been high we can see how the water vapour mixing ratio decreases into the free troposphere, especially between 2000 m and 6000 m (12.19).

This decreasing of the mixing ratio is negligible for January, for example, since in this month Saharan outbreaks tend to occur only at low altitudes. In this case, the air masses coming directly from Africa have a short path over the sea, transporting less water vapour.

12.4 References

Botey, R., J. A. Guijarro y A. Jiménez. “Valores normales de precipitación mensual 1981 – 2010”. Agencia Estatal de Meteorología. NIPO: 281-13-007-X. 2013.

Campanelli, M., A. Lupi, T. Nakajima, V. Malvestuto, C. Tomasi and V. Estellés (2010). Summertime columnar content of atmospheric water vapor from ground-based Sun-sky radiometer measurements through a new in situ procedure. *J. Geophys. Res.*, 115, D19304, doi: 10.1029/2009JD013211.

Hagemann, Stefan & Bengtsson, Lennart & Gendt, G. (2003). On the determination of atmospheric water vapor from GPS measurements. *Journal of Geophysical Research-Atmospheres*, v.108 (2003). 108. 10.1029/2002JD003235.

Lanzante, J., Resistant, Robust and Non-Parametric Techniques for the Analysis of Climate Data: Theory and Examples, including Applications to Historical Radiosonde Station Data. *International Journal of Climatology*, Vol. 16, 1197-1226, CCC 0899-8418/96111197-30, by the Royal Meteorological Society, 1996.

Romero Campos, P.M., Emilio Cuevas Agulló, Omaira García Rodríguez, Alberto J. Berjón Arroyo y Victoria E. Cachorro Revilla.: Aplicación de la Técnica de Campanelli para la calibración de los canales de vapor de agua de fotómetros CIMEL en el Observatorio Atmosférico de Izaña. NTD nº 2. NIPO: 784-11-010-6. Centro de Investigación Atmosférica de Izaña. Agencia Estatal de Meteorología (España), 2011.

Romero-Campos P.M., Marrero C., Alonso S., Cuevas E., Afonso S., and Ortiz de Galisteo J.P.: Una Climatología del Agua Precipitable en la Región Subtropical sobre la Isla de Tenerife basada en Datos de Radiosondeos. NTD nº 6 de AEMET. NIPO: 281-12-007-5. Centro de Investigación Atmosférica de Izaña. Agencia Estatal de Meteorología (España), 2011.

Schneider, M., Romero, P. M., Hase, F., Blumenstock, T., Cuevas, E., and Ramos, R.: Continuous quality assessment of atmospheric water vapour measurement techniques: FTIR, Cimel, MFRSR, GPS, and Vaisala RS92, *Atmos. Meas. Tech.*, 3, 323-338, doi:10.5194/amt-3-323-2010, 2010.

12.5 Staff

- Pedro Miguel Romero Campos (AEMET; Head of programme)
- Ramón Ramos (AEMET; Head of Infrastructure)
- Sergio Afonso (AEMET; Ozone and meteorological soundings expert technician)
- Dr Yballa Hernández (AEMET; lidar and ceilometer Fellowship) left IARC in November 2018

13 Meteorology

13.1 Izaña Atmospheric Observatory as a WMO Centennial Observing Station

Today, supercomputers and sophisticated models and satellites are important tools for climate scientists. However, long-term, high quality continuous observations from thermometers, rain gauges and other instruments remain essential. Without them, we could not be certain that the Earth has warmed by one degree centigrade over the past century. These long-term observations are vital to our scientific understanding of climate variability and change and essential for model and satellite validation activities.

To promote the recovery and continuation of these records, governments are nominating Centennial Observing Stations for formal recognition by WMO. Many Centennial Observation Stations are also of outstanding historical and cultural interest, recalling previous eras and the birth of modern meteorology. Taken together as a network, Centennial Observation Stations are uniquely able to tell the story of recent climatic history.

Izaña Atmospheric Observatory was recognised as a Centennial Observation Station by the WMO in 2017. More information about the WMO Centennial Observing Stations project, can be found [here](#).

13.2 Main Scientific Goals

The main goals of the meteorology programme are:

- To provide diagnosis and operational weather forecasting to support routine operation activities at the IARC observatories and issue internal severe weather alerts and special forecasts for planned field campaigns, outdoor calibrations, repairs, etc.
- To implement and configure High Resolution Numerical Weather Prediction Models capable of capturing the complex meteorology of the mountain observatory, as an aid to improve the supporting forecasts.
- To investigate the use of machine learning strategies to improve the forecasting of meteorological and air quality parameters.
- To maintain meteorological parameter observations according to WMO specifications, and in the framework of AEMET's Synoptic and Climatological Observation Networks.
- To measure conventional meteorological parameters at different stations on the island of Tenerife, to support other observation programmes.
- To recover historical meteorological data from various sources to complete the observational data of the Izaña station in the AEMET National Climatological Database (BDCN).



Figure 13.1. Izaña Atmospheric Observatory weather stations.

- To develop non-conventional meteorological parameters programmes.
- To provide meteorological analysis information and technical advice to interpret and support results from other observation programmes and scientific projects, designing and implementing specific algorithms and databases to reach these goals.

13.3 Measurement Programme

The Izaña Atmospheric Research Center directly manages six weather observation stations, located at IZO (3), SCO, BTO and TPO (see Section 3 for more details of the IARC facilities).

13.3.1 Izaña Atmospheric Observatory

IZO has three fully automatic weather stations, two of them are located in the weather garden (C430E/60010 and Meteo-STD), which includes a network of five cloud observation webcams, and the third station is on the instrument terrace of the observation tower (Meteo-Tower) at 30 m above ground level. Instrumentation for manual observations (staffed by personnel) with temperature, humidity, pressure and precipitation analog recorders (bands), is also maintained at IZO in order to preserve the historical series that started at Izaña Atmospheric Observatory in 1916.



Figure 13.2. Izaña Atmospheric Observatory, manual meteorological instrumentation.

13.3.2 Santa Cruz Observatory

SCO has a fully automatic weather station located on the instrument terrace.

13.3.3 Botanic Observatory

BTO has a fully automatic weather station installed at the ozonesounding station in the Botanic Garden in Puerto de la Cruz.

13.3.4 Teide Peak Observatory

TPO has an automatic very high altitude weather station with temperature, humidity and pressure sensors, supplemented with data from a wind sensor installed at the Cable Car tower No.4, managed by the Cable car company.

The meteorology programme also has access to meteorological soundings data of pressure, temperature, humidity and wind from the Tenerife station (ID: WMO 60018) located in the town of Güimar. This station belongs to the AEMET upper-air observation network and is managed by the Meteorological Center of Santa Cruz de Tenerife (AEMET).

13.4 Meteorological Resources

To accomplish the objectives of the meteorology programme we have the following tools.

13.4.1 Man Computer Interactive Data Access System (McIDAS)

LINUX Workstations (Fedora Core) with the Man Computer Interactive Data Access System (McIDAS) application provide access, exploitation and visualization of meteorological information from different geo-referenced observations, modelling and remote sensing (satellite, radar) platforms.

The application provides access to all data in real time in the AEMET National Prediction System, including the following data and products:

- Global synoptic surface observation and upper-air networks.

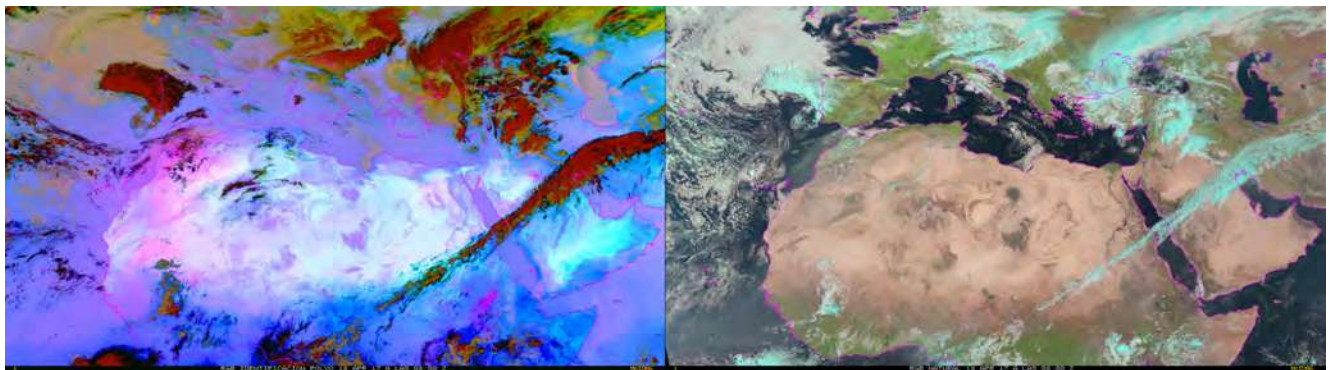

Figure 13.3. Two different RGB composite images from Meteosat-10 satellite for a dust event on 18/04/2017 08:00 UTC. Left panel: dust (channels 7, 9 and 10), right panel: natural (channels 1, 2 and 3).

- Outputs of numerical prediction models from ECMWF (IFS) and AEMET (HIRLAM).
- METEOSAT satellite imagery.
- Images of the AEMET Weather Radar Network.
- Data from the AEMET Electrical Discharge Detection network.
- Products derived from SAF (Satellite Application Facilities) Nowcasting MSG images.

Utilising this application different automated processes for the exploitation of meteorological information have been developed, among which we can highlight:

- 1) Automatic generation of graphical products from specific models and images from derived MSG products (RGB combinations), for consultation through an internal website (Fig. 13.3).
- 2) Calculation of isentropic back trajectories of air masses from analysis outputs (4 cycles per day) and prediction (every 12 hours and range up to 132 hours) for Tenerife at nine different vertical levels (Fig. 13.4).

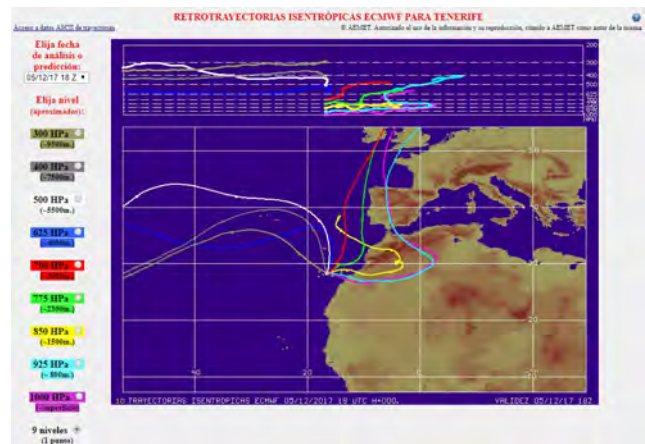

Figure 13.4. Screenshot of isentropic back-trajectories for Tenerife at nine levels on 05/12/2017 18 UTC.

- 3) Lightning strikes in situ detection and AEMET lightning detection network warning system, for taking preventive action to avoid damages in the facilities.

4) Automatic seven day Meteogram generation of temperature, humidity, wind, pressure and clouds for Izaña Observatory using standard isobaric grid points interpolated to 2400 m a.s.l. The statistics have been weighted using the inverse distance to the validity forecast time taking into account the last five available model runs (Fig. 13.5).

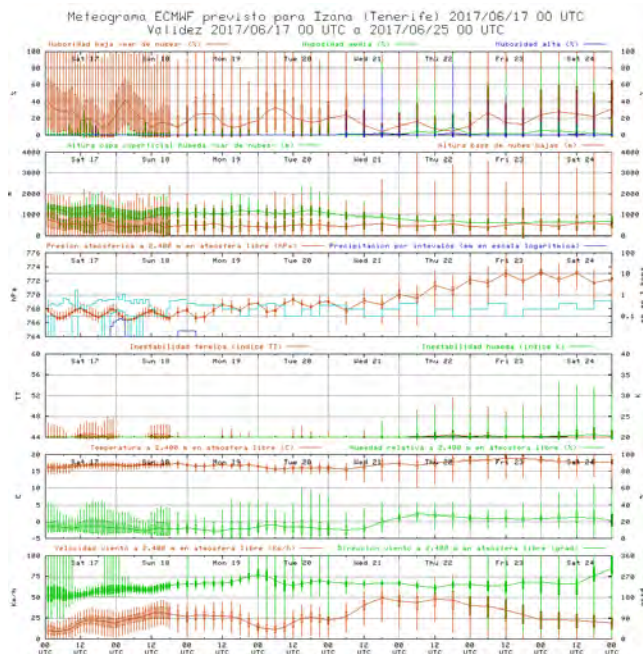

Figure 13.5. Ensemble week length meteogram forecast at IZO on 17/6/2017 at 00 UTC.

13.4.2 EUMETCast receiving system

The EUMETCast real-time receiving system for aerial imagery and meteorological satellite data distributed by EUMETSAT has its own internal web interface for displaying images received, and mass storage system for archiving images of compressed MSG segments in native format.

13.4.3 EUMETSAT Data Center

We have access to the EUMETSAT Data Center for retrieval of images and historical products of Meteosat satellites.

13.4.4 AEMET Server Meteorological Data System

We have access to numerical models databases, observations, bulletins, satellite and radar images is available on the AEMET Server Meteorological Data System (SSDM).

13.4.5 ECMWF products and MARS archive

In addition, we have access to the European Centre for Medium-Range Weather Forecasts (ECMWF) computer systems and consultation of the Meteorological Archival and Retrieval System (MARS), which is the archive of all operational products generated in ECMWF. From this

system we have developed different exploitation processes such as:

- Routine extraction in two cycles per day of meteorological analysis and prediction fields of the ECMWF IFS model, which are decoded in a compatible format for exploitation from McIDAS and for the integration of the high resolution model.
- Monthly extraction of ERA-Interim reanalysis outputs for updating large data series for different projects.
- Extraction of previous analysis fields calculation for computing back trajectories with FLEXTRA.
- Routine extraction in two cycles per day from Copernicus Atmosphere Monitoring Service (CAMS) system (Fig. 13.6).

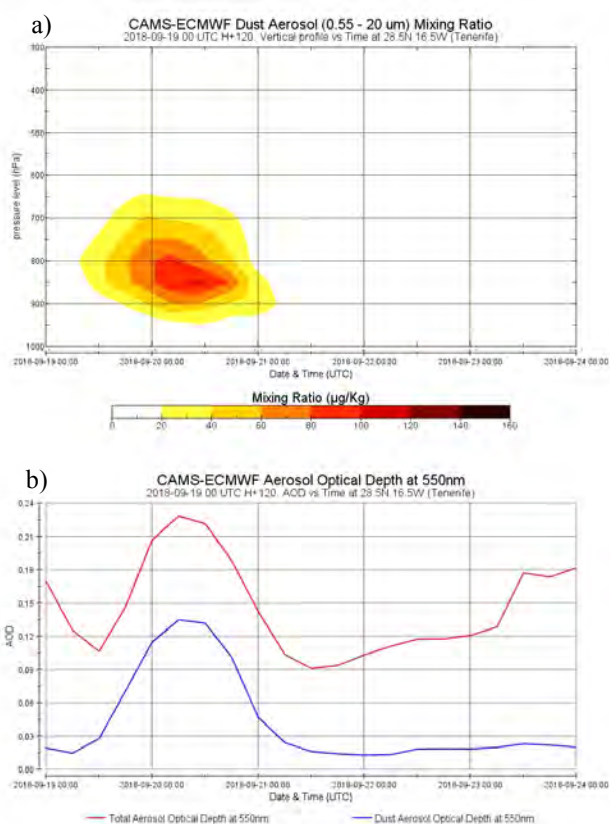

Figure 13.6. Examples of routine output cycles from CAMS. Forecast evolution of a) vertical profile of dust aerosol mixing ratio and b) Aerosol Optical Depth at 550 nm on 19/09/2018 00:00 UTC H+120 for 28.5N 16.5W (Tenerife).

13.4.6 AEMET National Climatological Data Base (BDCN)

We have access to the AEMET National Climatological Data Base (BDCN) for data extraction of observations from the AEMET principal and secondary climatological networks.

13.5 Numerical Models

13.5.1 Statistical forecasting model

A statistical forecasting model based on the analogous method shows the probability of occurrence of pollution events. In addition, meteorological values for a fixed point NE of Canary Islands, coloured depending on the quartile position relative to the historical values of the series, show at a glance the adverse meteorological conditions in a forecast range of 108 hours (for more details see Milford et al., 2008).

FECHA	HORA	DIR	ROSA	VEL	EPI	BLH	B_INV	C_INV	T_BAS	T_CIM	MEDIAN	PER99	>%70	>%80
06-06-2018	00	043	NE	7.1	3.2	648	645	809	13.9	14.5	*****	*****	**	**
06-06-2018	06	040	NE	7.3	2.9	602	601	1106	11.8	14.2	*****	*****	**	**
06-06-2018	12	045	NE	5.8	3.1	541	508	1109	13.1	15.0	10.0	20.0	17	0%
06-06-2018	18	022	NNE	6.4	3.5	542	508	810	14.7	15.8	*****	*****	**	**
07-06-2018	24	017	NNE	7.1	2.9	635	636	810	14.4	14.6	*****	*****	**	**
07-06-2018	30	018	NNE	6.3	3.4	406	410	1354	12.9	16.0	*****	*****	**	**
07-06-2018	36	010	N	6.2	4.1	484	411	1232	14.1	16.9	9.0	74.0	13	0%
07-06-2018	42	353	N	6.4	4.2	682	508	905	14.5	17.2	*****	*****	**	**
08-06-2018	48	349	N	6.5	4.6	582	458	813	15.1	18.0	*****	*****	**	**
08-06-2018	54	332	NNW	6.1	3.8	673	724	1004	13.6	16.8	*****	*****	**	**
08-06-2018	60	322	NNW	6.4	3.6	544	508	905	14.8	16.4	14.0	114.0	63	0%
08-06-2018	66	316	NNW	6.7	3.5	568	1354	1489	13.2	13.5	*****	*****	**	**
09-06-2018	72	343	NNW	5.0	2.4	569	1484	1950	11.9	13.5	*****	*****	**	**
09-06-2018	78	354	N	6.3	1.6	611	1239	1944	10.3	13.4	*****	*****	**	**
09-06-2018	84	007	N	6.0	1.2	509	1342	1776	9.2	13.2	9.0	22.0	08	0%
09-06-2018	90	010	N	6.0	0.8	526	1342	1774	9.1	13.0	*****	*****	**	**
10-06-2018	96	016	NNE	6.3	0.8	921	1475	1774	8.2	12.9	*****	*****	**	**
10-06-2018	102	021	NNE	6.6	1.1	733	1474	1937	7.5	12.7	*****	*****	**	**
10-06-2018	108	022	NNE	6.4	1.0	775	1476	1775	8.2	12.5	10.0	19.0	05	0%

Figure 13.7. Meteorological parameters summary table showing wind direction, wind velocity, Integrated Stability Parameter (EPI), boundary layer height (BLH), inversion layer height and temperature (base and top), median and 99 percentile of the analogous selected, and probability of exceedances over 80 and 70 percentiles of the historical series of SO₂ concentration.

13.5.2 The PSU/NCAR mesoscale model (MM5)

The meteorology programme has access to a clusters system in LINUX environment of parallel processors for the integration of a non-hydrostatic high resolution weather model (MM5) for the area of the Canary Islands. The initial and boundary conditions are from the ECMWF IFS model, and nested grids of 18, 6 and 2 km resolution are outputted with a forecasting range up to 144 hours.

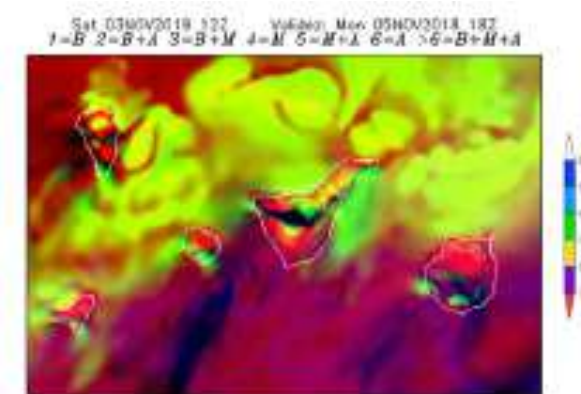

Figure 13.8. Example of graphics presented in MM5 web page. This shows the plot of the total cloud fraction (low+medium+high) shaded in colours on 5 November 2018 at 18 UTC.

13.5.3 The Weather Research and Forecasting (WRF) model

A Super Workstation based on the Xeon Phi KNL processor, with 72 cores at 1.5 GHz and RAM 64 GiB, and a CentOS7.3 OS with the Fortran and C++ compiler Intel Parallel Studio XE, support the integration of the WRF-ARW at very high resolution. The initial and boundary conditions are also from the ECMWF IFS model, and nested grids of 6, 2 and 1 km resolution are outputted with a forecasting range up to 72 hours. A high-mountain gust parameterization was implemented in WRF which greatly improves the wind gust forecast at both the Izaña Observatory and the Teide Peak Observatory (Fig. 13.9 and 13.10).

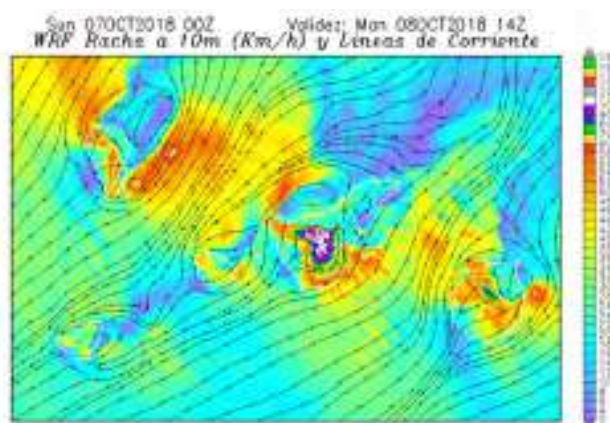

Figure 13.9. Example plot of forecasted wind gust velocity shaded in colours, overlapped with stream lines for a high wind speed episode on 8 October 2018 at 14 UTC.

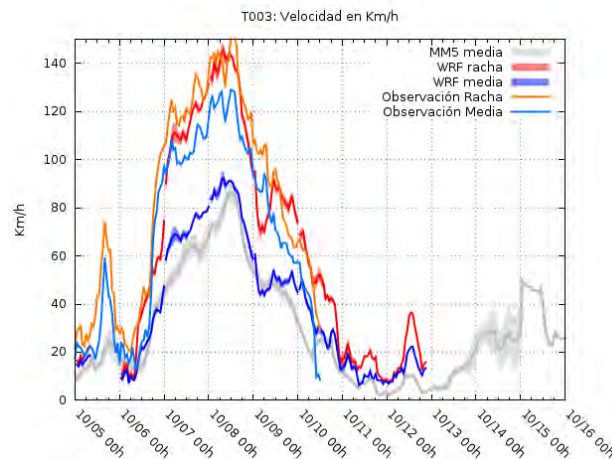

Figure 13.10. Example validation plot showing observed and forecasted wind and gust speeds from 5-16 October 2018. MM5 wind speed is also plotted.

13.5.4 Post-processed numerical results

The outputs of these models offer the added value of dynamic downscaling of the IFS model predictions for the complex topography of the Canary Islands. Various types of post-processed numerical fields permit a better understanding of the atmospheric situations. In addition to

these outputs a neural network has been implemented that improves the prediction of local variables of temperature and wind at the observatory, granting additional accuracy to the in situ forecast (Fig. 13.11). All these results are presented using a web server installed in the cluster.

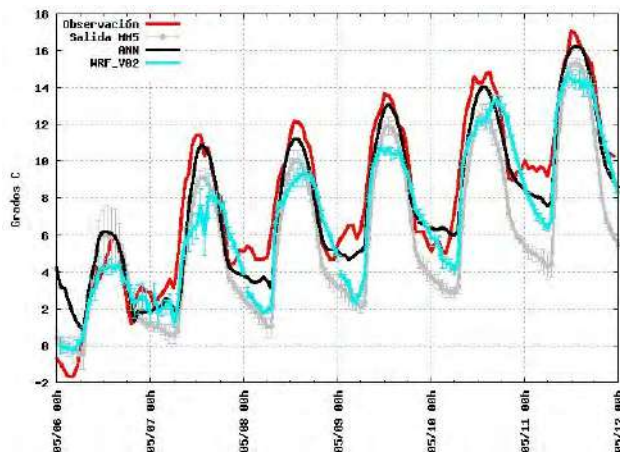

Figure 13.11. Example of the Artificial Neural Network 2 m forecast temperature improvement from 6-12 May 2018. Black lines represent the ANN values, while red, grey and blue lines represent observations and direct MM5 and WRF output, respectively.

13.5.5 FLEXible TRAjectory (FLEXTRA) model

The FLEXible TRAjectory (FLEXTRA) model is installed in a dedicated server and simulates 10-day back-trajectories arriving at Izaña Atmospheric Observatory calculated at several levels. The back-trajectories provide relevant information on transport and source regions of air masses affecting the various components and parameters measured at IZO. The back-trajectories have been calculated, and archived, at six hourly intervals for the 1979-2018 period.

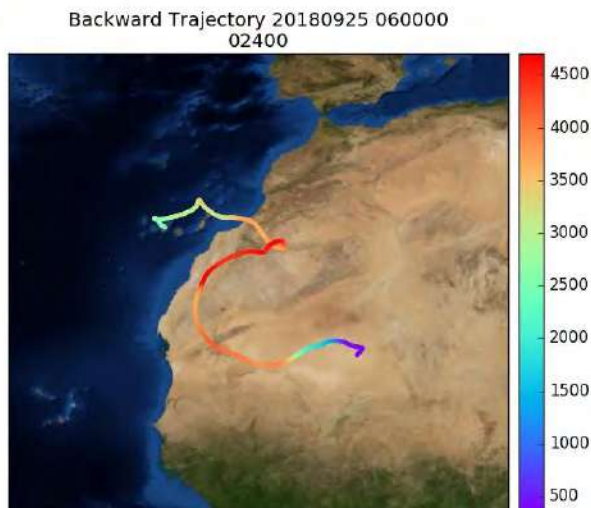

Figure 13.12. Image representing the track and height of a FLEXTRA back-trajectory with track ending on 25/09/2018 at 06 UTC.

Additional graphic information representing the track and its height is shown using a web server as a quick reference in order to select particular episodes (Figure 13.12). A later more exact representation can be requested using a McIidas web based server (Fig. 13.13).

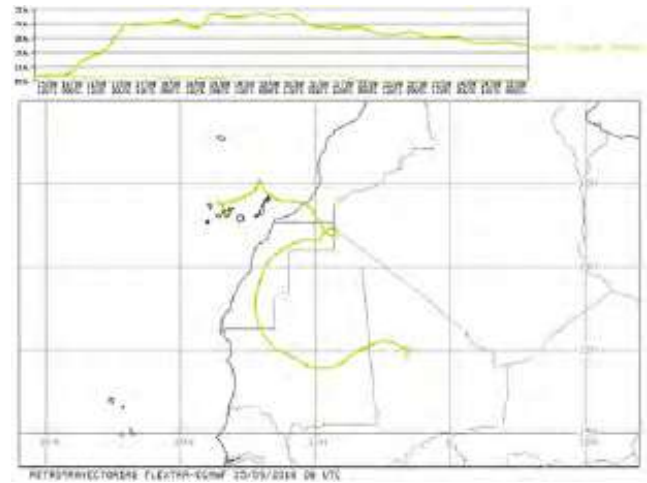

Figure 13.13. Detailed plot of a FLEXTRA back-trajectory with track ending on 25/09/2018 at 06 UTC.

13.5.6 HYbrid Single Particle Lagrangian Integrated Trajectory (HYSPLIT) model

The HYbrid Single Particle Lagrangian Integrated Trajectory (HYSPLIT) model has been installed on the same server as the FLEXTRA model in order to simulate 10-day back-trajectories using the National Centers for Environmental Prediction (NCEP) Global Forecast System (GFS) model as data input. The back-trajectories have been calculated, and archived, at six hourly intervals for the entire 1949-2018 period.

The HYSPLIT model has also been installed in the cluster system using MM5 output data and run in dispersion mode using the parallel program configuration (Figure 13.14).

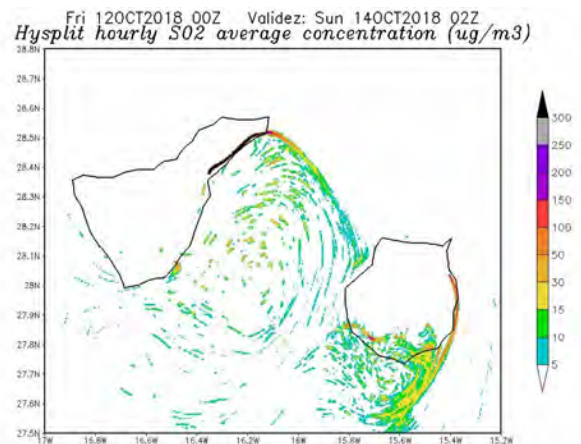

Figure 13.14. Average Hysplit SO₂ concentration shading contours forecasted on day 14/10/2018 at 02 UTC.

13.6 Summary of activities during the period 2017-2018

13.6.1 Meteorological long term records

The series of average temperature, accumulated precipitation, sunshine duration, average relative humidity and average atmospheric pressure at Izaña Atmospheric Observatory have been updated for the years 2017 and 2018 (Fig. 13.16). Additionally, historical meteorological data from various sources were recovered to complete the data series of the Izaña Long-term Observation Station; currently only 0.9% of days remain uncompleted between 1916-2018. This constitutes over a century of meteorological data and is the oldest uninterrupted climate series in the Canary Islands.

In the series of annual mean temperature at IZO (Fig. 13.16a), the rate of rise in temperature is maintained at 0.15°C per decade, consistent with the global warming trend. This series is especially relevant since the station is at altitude and is representative of conditions of quasi free troposphere. 2017 and 2018 lie in different classifications in relation to the 1961-90 reference series. The year 2017 constitutes, jointly with 2010, the two warmest years in the 103-year series with an annual mean temperature of 11.6°C (in the 5th quintile, very warm). In contrast, 2018 has an annual mean temperature of 9.5°C, and is classified as cold (in the 2nd quintile).

Regarding total annual precipitation (Fig. 13.16b), both 2017 and 2018 have precipitation rates less than the 1961-90 median value. 2017 total annual precipitation is only 142.7 mm and is classified as very dry (in the 1st quintile), while in 2018 the total annual precipitation reached a value of 359.5 mm and is classified as normal (in the 3rd quintile).

The total annual sunshine duration series also maintains a significant increasing trend of 36.4 h per decade trend (Fig. 13.16c). Both 2017 and 2018 have total annual sunshine duration of above 3800 h (> 85% of the maximum possible number of hours). In 2017, total annual sunshine duration reached 3857.3 h, very close to the maximum value of the long-term record obtained in 2015.

The series of annual mean relative humidity (13.16d) continues the downward trend that began after the high values of the second half of the 20th century. The evolution of the annual mean atmospheric pressure (13.16e) remains fairly stable from the beginning of the 21st century, after the multidecadal oscillation seen in the last century.

An analysis was conducted to compare the meteorology of 2017 and 2018 at IZO to the long term meteorological records. For example, 2017 broke the records for the highest June and October monthly mean temperatures (Table 13.1).

Table 13.1. Meteorology of 2017 and 2018 at IZO in comparison with 1916-2018 meteorological records.

Extreme Event	Data	Date
Highest May maximum 10' mean velocity	94 km/h	9/5/2017
Highest August daily minimum temperature at 15 cm depth	20.6 °C	20/8/2017
Maximum January 10' precipitation	3.6 mm	31/1/2018
Highest June monthly mean temperature	17.2 °C	Jun 2017
Highest October monthly mean temperature	13.2 °C	Oct 2017

To ensure quality and continuity of observations within national and international meteorological and climatological observation networks in which IARC participates requires constant maintenance and vigilance of meteorological instrumentation and subsequent quality checking of meteorological data from IZO, SCO, BTO and TPO.

The networks in which IARC participates are the Synoptic Observation Network (WMO Region I, ID: 60010), included in the surface observation network of Global Climate Observing System (GCOS), the AEMET Climatological Monitoring Network (ID C430E) and the Baseline Surface Radiation Network (BSRN; station # 61).

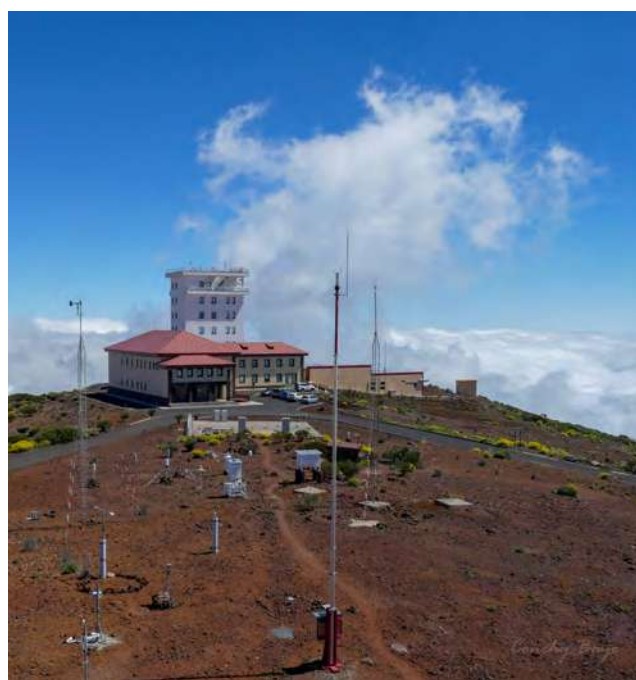

Figure 13.15. Izaña Atmospheric Observatory weather stations.

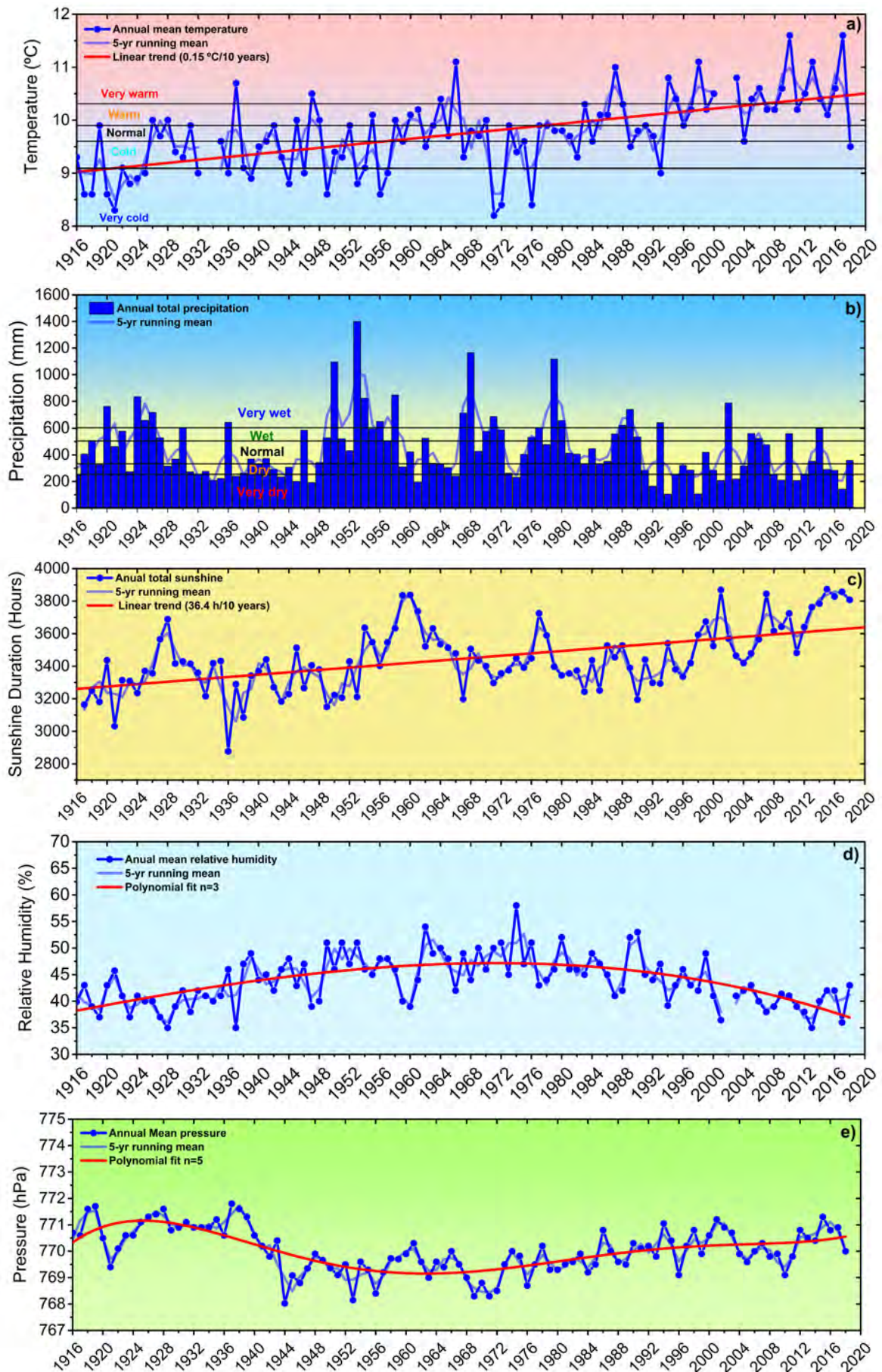

Figure 13.16. Time series (1916-2018) of a) annual mean temperature, b) total annual precipitation, c) annual sunshine duration, d) annual mean relative humidity and e) annual mean pressure at Izaña Atmospheric Observatory.

13.6.2 Prediction and analysis of severe weather events

Additional activities of the Meteorology programme include prediction and subsequent analysis of severe weather events that may affect operations of the various observation programmes at the four IARC observatories. Special attention is paid to IZO, which is frequently affected by adverse events such as very strong winds, rain and heavy snow, lighting, frost, and frozen rime, which can cause significant damages to facilities. We highlight some of the most important episodes during 2017-2018:

On 12 February 2017, a deep depression to the north of the Canary Islands produced in Izaña a strong wind storm with gusts above 120 km/h persisting for almost 6 hours, a maximum average speed in 10' of 113.4 km/h and a maximum gust of 141.5 km/h. The atmospheric pressure dropped to a value of 746.8 hPa, and the temperature decreased to a minimum of -4.7°C.

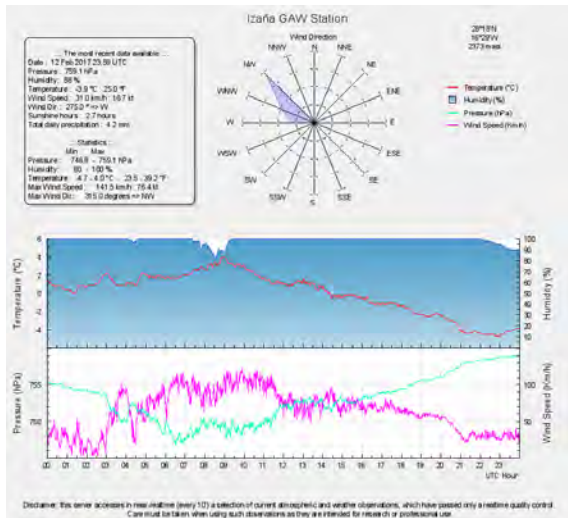

Figure 13.17. Relative humidity, temperature, wind velocity and pressure graphics recorded on 12 February 2017.

Between 17-19 March 2017, a cold depression centered to the north of the Canary Islands produced an episode of moderate snowfall at the Observatory, with an accumulation of 20.4 mm and minimum temperature of -3.4°C (Fig. 13.18).

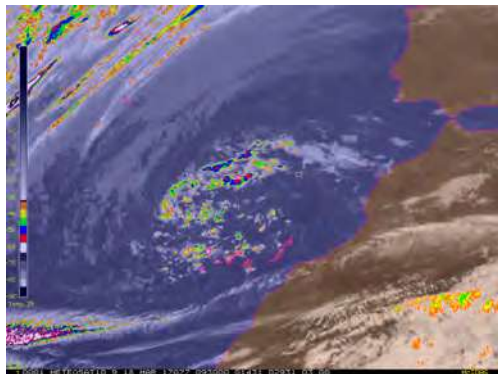

Figure 13.18. Meteosat-10 IR 10.8 image on 18/03/2017 09:30 UTC.

On 9 May 2017 there was a storm produced by the interaction of a deep and extensive low to the NW of the Canary Islands and the subtropical jet stream, in which wind gusts reached up to 124.9 km/h (08:40 UTC).

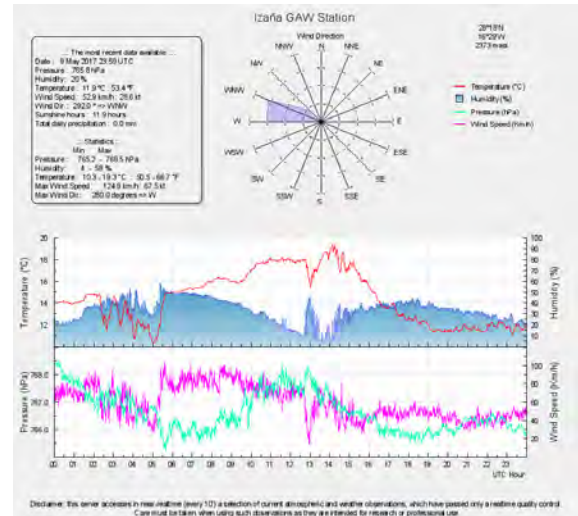

Figure 13.19. Relative humidity, temperature, wind velocity and pressure graphics recorded on 9 May 2017.

Between 11-12 December 2017 a very active cold front associated with a deep low, produced a total of 51.6 mm of rain in just over 24 h, which represented the only notable precipitation episode in the whole of 2017.

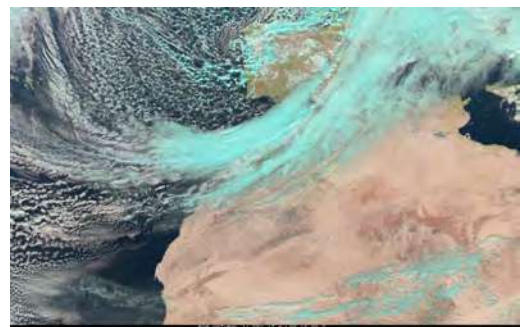

Figure 13.20. Meteosat RGB natural (VIS 0.6, VIS 0.8 and IR1.6) image on 11/12/2017 12 UTC.

On 8 January 2018, a quasi-stationary cold low centered to the NE of the Canary Islands produced a winter storm which lasted for several days with the entry of very cold air and a second low occurred in a similar position on 7 February.



Figure 13.21. Photograph of the snow accumulation at the Observatory, 8 February 2018.

Temperatures were maintained uninterruptedly below 0°C for more than 10 days, and there was a significant accumulation of rime. The maximum wind speed reached 157 km/h on February 8 at 05:10 UTC, with a minimum temperature of -6.2°C on January 30 at 00:00 UTC, and 122.6 mm of accumulated precipitation throughout the episode.

On 28 February 2018, there was a strong 2-day storm, produced by a deep depression located over the Azores Islands that was named as a “High impact storm” by the Portuguese Meteorological Service. A maximum gust of 158 km/h was recorded on 1 March at 02:40 UTC.

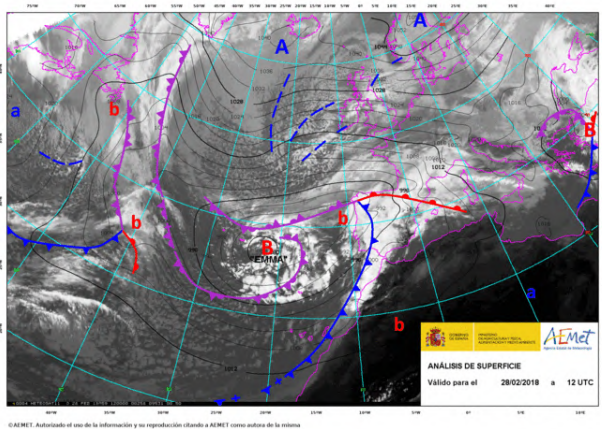

Figure 13.22. Map of sea level air pressure and fronts on Meteosat IR image prepared by AEMET for 28 February 2018.

On 20-21 April 2018 there was an anomalous episode of strong wind and cold temperatures, with a maximum gust of 112.3 km/h on 20/4/2018 at 17:50 UTC, and a minimum temperature of -5.5°C at 20:10 UTC.

On 13 August 2018, a convective band from Africa produced anomalous summer storm activity in the Canary Islands, registering a precipitation of 9.4 mm in the Observatory.

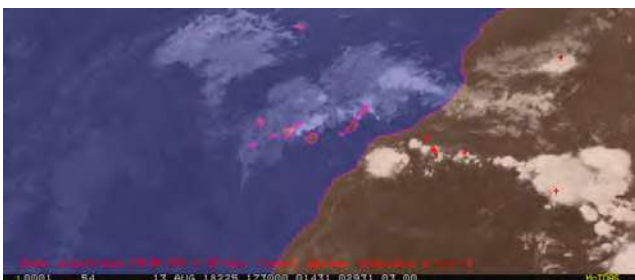

Figure 13.23. Meteosat-10 IR 10.8 image on 13/08/2018 17:30 UTC.

Between 24-25 October 2018, a medium-level convergence band located in the southern circulation of a low to the NW of the Canary Islands, produced convective instability with electrical activity that led to intense rainfall at various times, accumulating a total of 51.6 mm of rain over Izaña.

13.7 Outstanding collaborations with other scientific programmes

Collaborations with other scientific programmes during 2017-2018 include the following.

A collaboration was undertaken with the Tenerife Island Government to study the impact of the temperature, precipitation and clouds on the ecosystem in Las Cañadas del Teide using a year of data collected from the MM5 historical simulations at high resolution.

Seasonal statistics of simultaneous wind speed and cloudiness based on MM5 historical outputs at high resolution, have been included in a report sent to EUMETSAT to assess El Hierro as a potential Satellite Calibration Buoy site.

Various modifications of routines of the FLEXTRA program have been made in order to take into account particle properties. A series of simulations have been made in order to assess the impact on the results in collaboration with the Greenhouse Gases and Carbon Cycle and the Aerosol Groups.

An experiment has been conducted to assess the impact of hourly FLEXTRA output on the capture of specific events from 23 August -1 September 2010 in collaboration with the Aerosols Group.

A database has been designed and created with data from the Canary Islands Government Air Quality observational network and SDS-WAS Multi-Model forecasts interpolated to the air quality network sites. This information will be used in a machine learning strategy project to improve the quality of forecasted PM₁₀ values due to African dust intrusions in conjunction with the Barcelona Supercomputer Centre.

A new index, African Residence Time Index (ARTI), based on FLEXTRA back-trajectories has been designed to distinguish between a high probability of African dust intrusion days and non-dust days at a specific site. This index has been used extensively by various groups in IARC.

We have implemented algorithms to forecast the view angle from the ozone sounding system antenna reception position and the driving balloon, to assure radio coverage during the flight. This software, in conjunction with the ASTRA High Altitude Balloon Flight Planner, was able to increase the rate of successful flights to near 100%. It is routinely used by the Ozone and UV Group.

In situ weather forecasts and specific HYSPLIT and FLEXTRA back-trajectories have been conducted for the MEGEI-MAD campaign carried out in Madrid from 24 September - 7 October 2018, in collaboration with the FTIR Group (for more details see Section 7.3.2 and García et al., 2018a).

A specialised software has been developed to extract information of regular atmospheric soundings in order to process vertical precipitable water as requested by the Radiation and Water Vapour Groups.

We participated in the Training Course on "Atmospheric Aerosols and Mineral Dust" organized by IARC, held from 20 June – 6 July 2017. We presented a summary of the high resolution tools used by the Meteorology Group in order to improve the Izaña site operational forecasts with special emphasis on the lagrangian trajectories tools used, both FLEXTRA and HYSPLIT, showing in detail the running system configurations.

We participated as co-authors in several presentations of the 9th International Workshop on Sand/Dust Storms and Associated Dustfall, 22-24 May 2018 (for more details see Section 26) and in a presentation in the 11th International Conference on Air Quality - Science and Application, 12-16 March 2018:

- Long-term aerosol optical depth (1941-2017) at the Izaña Observatory (García et al., 2018b).
- Short-term variations of the Saharan Air Layer atmospheric properties over the North Atlantic driven by NAFDI: Summer 2017 case analysis (Cuevas et al., 2018).
- Northern African sources of mineral dust from measurements at the Izaña GAW Observatory (López-Solano, et al., 2018).
- High variability of dust composition in the Saharan Air Layer (Rodríguez, et al., 2018).
- Air quality trends in a coastal city, Santa Cruz de Tenerife (Milford, et al., 2018).

13.8 References

Cuevas, E., Bustos, J.J., Rodríguez, S., Marrero, C., Reyes, E., García, R.D., García, O.E., Barreto, A. and Guirado-Fuentes, C. Short-term variations of the Saharan Air Layer atmospheric properties over the North Atlantic driven by NAFDI: Summer 2017 case analysis. 9th International Workshop on Sand/Dust storms and Associated Dustfall, La Laguna, Tenerife, Spain, 22-24 May 2018.

García, O., E. Sepúlveda, J.-A. Morgui, C. Estruch, R. Curcoll, M. Frey, C. Schneider, R. Ramos, C. Torres, S. León, F. Hase, A. Butz, C. Toledano, E. Cuevas, T. Blumenstock, C. Pérez, M. Guevara, J. J. Bustos, and V. Carreño. MEGEI-MAD: Monitoring of Greenhouse Gases Concentrations in Madrid. Integrated Global Greenhouse Gas Information System (IG3IS) Symposium, 13 – 15 November, WMO, Geneva, Switzerland, 2018a.

García, R.D., O.E. García, E. Cuevas and J.J. Bustos, Long-term aerosol optical depth (1941-2017) at the Izaña Observatory. 9th International Workshop on Sand/Dust storms and Associated Dustfall, La Laguna, Tenerife, Spain, 22-24 May 2018b.

López-Solano, J., Rodríguez, S., Pérez García-Pando, C., Sosa, E., García, M. I., Bustos, J.J., Marrero, C. and Alonso-Pérez, S. Northern African sources of mineral dust from measurements at the Izaña GAW Observatory. 9th International Workshop on

Sand/Dust storms and Associated Dustfall, La Laguna, Tenerife, Spain, 22-24 May 2018.

Milford, C., Cuevas, E., Marrero, C., Bustos, J.J., Torres, C. Air quality trends in a coastal city, Santa Cruz de Tenerife. 11th International Conference on Air Quality - Science and Application, Barcelona, Spain, 12-16 March 2018.

Milford, C., Marrero, C., Martin, C., Bustos, J. & Querol, X. Forecasting the air pollution episode potential in the Canary Islands. Adv. Sci. Res. 2, 21–26, 2008.

Rodríguez, S., Lucarelli, F., Nava, S., García, M.I., López-Solano, J., Marrero, C., Cuevas, E., Prats, N., High variability of dust composition in the Saharan Air Layer. 9th International Workshop on Sand/Dust storms and Associated Dustfall, La Laguna, Tenerife, Spain, 22-24 May 2018.

13.9 Staff

Carlos Luis Marrero de la Santa Cruz (AEMET; Head of programme)

Juan José Bustos (AEMET; Research Scientist)

Ramón Ramos (AEMET; Head of Infrastructure, Responsible for Meteorological Observation Programme)

Cándida Hernández (AEMET; Meteorological Observer-GAW Technician)

Concepción Bayo (AEMET; Meteorological Observer-GAW Technician)

Virgilio Carreño (AEMET; Meteorological Observer-GAW Technician)

Dr Fernando de Ory (AEMET; Meteorological Observer-GAW Technician) left IARC in October 2018

Sergio Afonso (AEMET; Meteorological Observer-GAW Technician)

Dr Emilio Cuevas (AEMET; Research Scientist)

Dr Rosa García (AIR LIQUIDE; Research Scientist)

14 Aerobiology

The Aerobiology programme at the IARC is carried out jointly by IARC-AEMET and the Laboratori d'Anàlisis Palinològiques (LAP) of the Universidad Autónoma de Barcelona (UAB) with partial financing from Air Liquide España S.A through the Eolo-PAT project. This programme started in 2004 at SCO with the aim of improving the knowledge of the pollen and spore content in the air of Santa Cruz de Tenerife and its relation with the prevalence of respiratory allergy. A second aerobiological station was implemented at IZO thanks to the financial support of the R+D National Plan CGL-2005-07543 project (“Origin, transport and deposition of African atmospheric aerosol in the Canaries and the Iberian Peninsula based on its Chemical and Aerobiological Characterization”). These two projects also contribute to improve the knowledge of the biological fraction of aerosols within the GAW program.

14.1 Main Scientific Goals

The main scientific goals of this programme are:

- To produce high quality standardized data on the biological component of the atmospheric aerosol.
- To establish the biodiversity and quantity of pollen and fungal spores registered in the air of Santa Cruz de Tenerife and Izaña.
- To establish the distribution pattern over the course of the year of the airborne pollen and fungal spores at Santa Cruz de Tenerife and Izaña, through the daily spectra.
- To put the Canary islands on the map of the global aerobiological panorama, along with the Spanish (REA; SEAIC) and European networks (EAN).
- To provide information useful for medical specialists and allergic patients.
- To set up the list of the allergenic pollen and spore taxa in the air of Santa Cruz de Tenerife and Izaña that will help doctors to diagnose the allergy aetiology and to rationalize the use of the medication.
- To produce weekly alerts on the allergenic pollen and spores for the days ahead to help doctors in the allergy detection and to help people suffering from allergies with a better planning of their activities and to improve the quality of their life.

A detailed description of this programme can be found in Belmonte et al. (2011).

14.2 Measurement Programme

The sampling instrument is a Hirst, 7-day recorder VPPS 2000 spore trap (Lanzoni S.r.l.) (Fig. 14.1) and the analysing instrument is a Light microscope, 600 X (Table 3.2). The pollen and spore analysis is conducted using palynological methods following the recommendations of the Spanish Aerobiology Network management and quality manual and the recommendations of the European Aerobiology Society (Galán et al. 2017). The sampling programme at SCO is continuous through the year, whereas samples are only collected at IZO from April-May to November because of adverse meteorological conditions during the rest of the year.

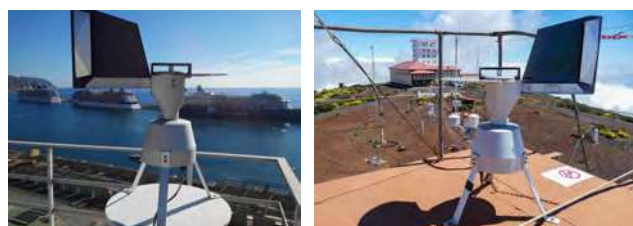

Figure 14.1. Hirst, 7-day recorder VPPS 2000 spore trap at SCO (left) and at IZO (right).

14.3 Summary of remarkable results during the period 2017

The annual dynamics of the total pollen and total fungal spores taxa in Santa Cruz de Tenerife and Izaña are shown in Figs. 14.2 and 14.3. Data shown correspond to mean weekly concentrations.

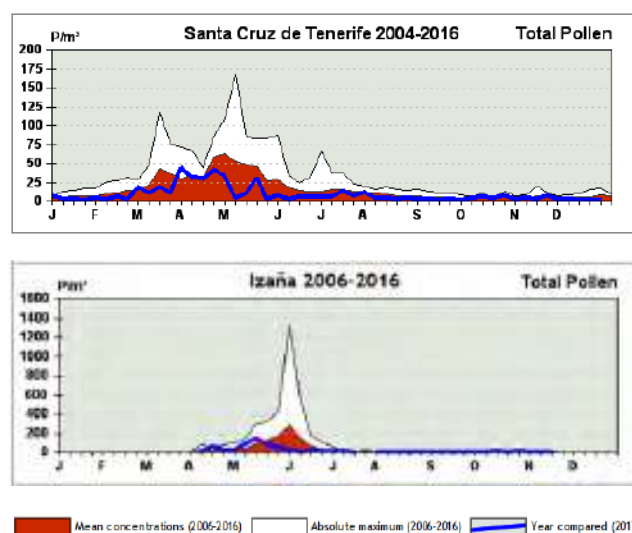

Figure 14.2. Dynamics of the mean weekly Total Pollen concentrations in Santa Cruz de Tenerife (upper) and Izaña (lower) during 2017 in comparison with 2004-2016 mean data.

Table 14.1. Airborne pollen and spore spectrum for SCO, year 2017.

SANTA CRUZ DE TENERIFE
1 January 2017 - 31 December 2017

	YEAR		WEEK		DAY	
	Integral P*day/m ³	Percentage %	Maximum P/m ³	Week nr. Nr.	Maximum P/m ³	Date of the Maximum dd/mm/yyyy
TOTAL POLLEN	3163	100	44.5	13	158.2	22/14/2017
POLLEN FROM TREES	1431	45.2	22.2	16	84.0	22/04/2017
<i>Acacia</i>	0	0.0	0.0	-	0.0	-
<i>Ailanthus</i>	1	0.0	0.1	20	0.7	17/05/2017; 01/12/2017
<i>Alnus</i>	0	0.0	0.0	-	0.0	-
<i>Castanea</i>	15	0.5	0.8	24	3.5	15/06/2017
<i>Casuarina</i>	19	0.6	1.6	47	4.9	21/11/2017
CUPRESSACEAE	90	2.8	1.5	7	7.0	16/03/2017
<i>Eucalyptus</i>	29	0.9	0.8	12	5.6	23/03/2017
<i>Ilex</i>	0	0.0	0.0	-	0.0	-
MORACEAE	55	1.7	1.6	30	9.8	30/05/2017
<i>Myrica</i>	679	21.5	20.8	16	82.6	22/04/2017
OLEACEAE	78	2.5	6.7	20	21.0	17/05/2017
PALM TREES	221	7.0	5.5	28	12.6	24/07/2017
<i>Pinus</i>	81	2.6	4.3	15	18.9	10/04/2017
<i>Platanus</i>	8	0.3	0.5	7	2.1	16/02/2017
<i>Populus</i>	1	0.0	0.1	22	0.7	02/06/2017
<i>Quercus</i> total	16	0.5	0.8	15	4.2	10/04/2017
<i>Salix</i>	11	0.3	0.7	5	2.8	01/02/2017
<i>Schinus</i>	125	3.9	2.5	46	16.8	14/11/2017
<i>Tilia</i>	0	0.0	0.0	-	0.0	-
<i>Ulmus</i>	0	0.0	0.0	-	0.0	-
Other pollen from trees	2	0.0	-	-	-	-
POLLEN FROM SHRUBS	430	13.6	12.7	13	47.6	30/03/2017
CISTACEAE	0	0.0	0.0	-	0.0	-
ERICACEAE	400	12.6	12.0	13	46.9	30/03/2017
<i>Ricinus</i>	26	0.8	0.5	1	1.4	04/01/2017; 20/01/2017; 09/02/2017
<i>Pistacia</i>	2	0.1	0.1	10	0.7	12/03/2017; 02/04/2017; 25/05/2017
Other pollen from shrubs	2	0.1	-	-	-	-
POLLEN FROM HERBS	1175	37.2	18.7	20	44.1	17/05/2017
COMPOSITAE total (incl. <i>Artemisia</i>)	405	12.8	10.5	20	35.0	30/04/2017; 17/05/2017
<i>Artemisia</i>	365	11.5	10.3	20	35.0	30/04/2017
BORAGINACEAE	22	0.7	2.5	1	8.4	07/01/2017
CYPERACEAE	13	0.4	0.4	41	1.4	07/01/2017; 14/10/2017; 25/11/2017
CRASSULACEAE	1	0.0	0.0	1	0.7	01/01/2017
CRUCIFERAE	13	0.4	0.2	2	1.4	02/03/2017
<i>Euphorbia</i>	0	0.0	0.0	-	0.0	-
GRAMINEAE (Grasses)	159	5.0	2.3	17	5.6	10/07/2017
<i>Mercurialis</i>	18	0.6	0.6	11	2.1	14/03/2017; 31/03/2017
<i>Plantago</i>	41	1.3	1.0	10	5.6	31/03/2017
<i>Rumex</i>	69	2.2	1.7	11	3.5	16/03/2017
CHENOPODIACEAE/AMARANTHACEAE	169	5.4	3.5	43	10.5	27/10/2017
URTICACEAE	178	5.6	3.8	13	5.6	04/03/2017; 27/3/2017
Other pollen from herbs	89	2.9	-	-	-	-

	YEAR		WEEK		DAY	
	Integral S*day/m ³	Percentage %	Maximum S/m ³	Week nr. Nr.	Maximum S/m ³	Date of the Maximum dd/mm/yyyy
TOTAL SPORES	102847	100.0	1455.6	20	4121.6	17/05/2017
<i>Alternaria</i>	1425	1.4	27.2	20	75.6	17/05/2017
Ascospores	27796	27.0	239.2	43	1226.4	24/19/2017
<i>Aspergillus/Penicillium</i>	2142	2.1	53.6	50	294.0	11/12/2017
<i>Cladosporium</i>	58971	57.3	1230.4	20	3668.0	17/05/2017
<i>Ustilago</i>	4721	4.6	56.4	20	210.0	17/05/2017
Other fungal spores	7793	7.6	-	-	-	-

Table 14.2. Airborne pollen and spore spectrum for IZO, year 2017.

IZAÑA

3 April 2017 - 19 November 2017

	YEAR		WEEK		DAY	
	Integral P*day/m ³	Percentage %	Maximum P/m ³	Week nr. Nr.	Maximum P/m ³	Date of the Maximum dd/mm/yyyy
TOTAL POLLEN	4070	100	135.8	19	310.8	10/05/2017
POLLEN FROM TREES	683	16.8	40.7	15	97.3	13/04/2017
<i>Acacia</i>	0	0.0	0.0	-	0.0	-
<i>Ailanthus</i>	0	0.0	0.0	-	0.0	-
<i>Alnus</i>	0	0.0	0.0	-	0.0	-
<i>Castanea</i>	18	0.4	1.6	26	4.9	02/07/2017
<i>Casuarina</i>	1	0.0	0.1	41	0.7	13/10/2017
CUPRESSACEAE	9	0.2	0.3	43	1.4	13/04/2017 ; 26/10/2017
<i>Eucalyptus</i>	0	0.0	0.0	-	0.0	-
<i>Ilex</i>	1	0.0	0.1	19	0.7	11/05/2017
MORACEAE	0	0.0	0.0	-	0.0	-
<i>Myrica</i>	298	7.3	16.7	17	53.2	25/04/2017
OLEACEAE	6	0.2	0.3	15; 20	1.4	16/04/2017
PALM TREES	19	0.5	1.7	43	11.9	28/10/2017
<i>Pinus</i>	323	7.9	26.6	15	67.2	13/04/2017
<i>Platanus</i>	1	0.0	0.1	15	0.7	13/04/2017
<i>Populus</i>	0	0.0	0.0	-	0.0	-
<i>Quercus</i>	6	0.1	0.3	22	1.4	04/06/2017
<i>Salix</i>	0	0.0	0.0	-	0.0	-
<i>Schinus</i>	1	0.0	0.1	23	0.7	10/06/2017
<i>Tilia</i>	0	0.0	0.0	-	0.0	-
<i>Ulmus</i>	0	0.0	0.0	-	0.0	-
Other pollen from trees	2	0.1	-	-	-	-
POLLEN FROM SHRUBS	49	1.2	3.3	15	7.0	14/04/2017
CISTACEAE	0	0.0	0.0	-	0.0	-
ERICACEAE	48	1.2	3.3	15	7.0	14/04/2017
<i>Ricinus</i>	0	0.0	0.0	-	0.0	-
<i>Pistacia</i>	0	0.0	0.0	-	0.0	-
Other pollen from shrubs	1	0.0	-	-	-	-
POLLEN FROM HERBS	3230	79.4	131.1	19	295.4	10/05/2017
COMPOSITAE total (incl. <i>Artemisia</i>)	41	1.0	2.0	15	7.7	16/04/2017
<i>Artemisia</i>	29	0.7	1.7	15	5.6	16/04/2017
BORAGINACEAE	17	0.4	1.1	14	7.7	03/04/2017
CYPERACEAE	12	0.3	0.7	41	2.1	14/10/2017
CRASSULACEAE	0	0.0	0.0	-	0.0	-
CRUCIFERAE	2832	69.6	129.8	19	292.6	10/05/2017
<i>Euphorbia</i>	0	0.0	0.0	-	0.0	-
GRAMINEAE (Grasses)	81	2.0	1.5	24	5.6	18/06/2017; 01/08/2017
<i>Mercurialis</i>	2	0.1	0.2	15	0.7	03/04/2017; 10/04/2017; 14/04/2017
<i>Plantago</i>	5	0.1	0.2	15	0.7	13/04/2017; 14/04/2017; 17/05/2017
<i>Rumex</i>	25	0.6	1.1	15	3.5	17/05/2017
CHENOPODIACEAE/AMARANTHACEAE	113	2.8	4.0	41	11.2	15/10/2017
URTICACEAE	97	2.4	2.9	15	7.7	28/05/2017
Other pollen from herbs	5	0.2	-	-	-	-

	YEAR		WEEK		DAY	
	Integral S*day/m ³	Percentage %	Maximum S/m ³	Week nr. Nr.	Maximum S/m ³	Date of the Maximum dd/mm/yyyy
TOTAL SPORES	23108	100.0	287.2	20	599.2	17/05/2017
<i>Alternaria</i>	647	2.8	12.0	19	30.8	29/09/2017
Ascospores	6434	27.8	62.8	45	123.2	10/05/2017
<i>Aspergillus/Penicillium</i>	384	1.7	18.0	20	126.0	17/05/2017
<i>Cladosporium</i>	9960	43.1	215.2	20	361.2	17/05/2017
<i>Ustilago</i>	2990	12.9	88.4	40	459.2	06/10/2017
Other fungal spores	2693	11.7	-	-	-	-

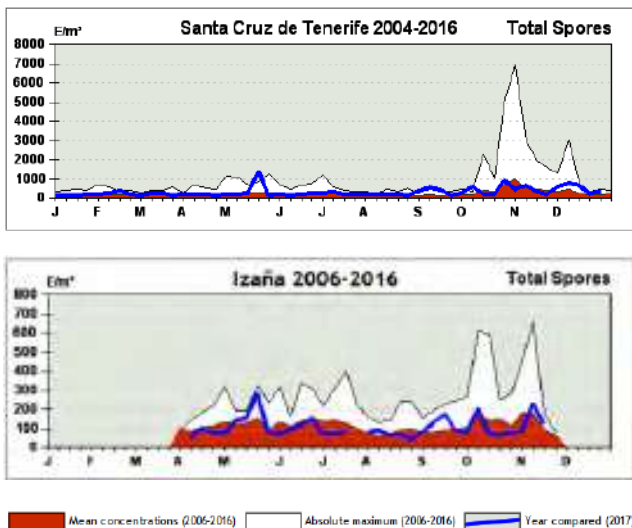

Figure 14.3. Dynamics of the mean weekly Total Fungal Spore concentrations in Santa Cruz de Tenerife (upper) and Izaña (lower) during 2017 in comparison with 2004-2016 mean data.

Similar graphs for each particular taxa can be generated on the [webpage](#).

The plots show that the annual course of total concentration of pollen and fungal spores at SCO is very different from that observed at IZO, which presents a great interannual variation depending on weather conditions such as temperature and precipitation. While in SCO concentration of pollen shows a broad maximum covering an extensive spring season (February to June), in IZO higher pollen concentrations happen in two months (usually from May to late June, but advanced to April and May in 2017) with values that can be much higher than those recorded for SCO, although this was not the case in 2017. Year 2017 showed retarded pollinations with regard to the mean data (except for *Myrica* and *Erica*) and concentrations below the mean values most of the year in SCO and IZO. Brassicaceae pollen lost importance in IZO (Fig. 14.2 and Tables 14.1 and 14.2).

The total concentration of fungal spores shows a contrasting seasonal variation to that of total pollen. In 2017 in SCO the highest concentrations occurred between September and December, beginning earlier than usual, and reached values similar to the mean ones. At IZO, in 2017, fungal spores concentrations were greater than the mean values twice, in May and September. There is a big difference in the order of magnitude of the concentrations recorded in SCO (higher) and IZO (Fig. 14.3).

These results refer to total concentration of pollens and fungal spores. However individual pollens and fungal spores might have a quite different seasonal behaviour at each station ((see Tables 14.1 and 14.2 and graphs that can be generated on the [webpage](#)).

A number of products, such as current levels and forecasts of the main allergenic pollens and fungal spores, historical

and current data and pollen calendar for SCO can be found at the Tenerife Aerobiology information (Proyecto EOLO-PAT) [web page](#).

14.4 Future Activities

- Continuation of pollens and fungal spores sampling, and aerobiological data analysis.
- Update of the airborne pollen and spores databases.
- Improvement of the information provided through the [webpage](#) and services to its users.
- Trend analysis.
- Internannual variability versus meteorology.

14.5 References

- Belmonte, J., Cuevas, E., Poza, P., González, R., Roure, J.M., Puigdemunt, R., Alonso-Pérez, S., Grau, F. *Aerobiología y alergias respiratorias de Tenerife*. Editor: Agencia Estatal de Meteorología/Ministerio de Medio Ambiente y Medio Rural y Marino, 2010. NIPO (versión electrónica): 784-10-006-2.
- Belmonte, J., C. De Linares, A. Fernández-Llamazares, C. Díaz de la Guardia, P. Cariñanos, S. Alonso-Pérez, E. Cuevas, J.M. Maya, S. Fernández, I. Silva, R. Tormo, *Airborne Pinus pollen in Spain: pollination patterns and trends of the annual indexes and the peak dates*, 5th European Symposium on Aerobiology, Krakow, Poland, 3 - 7 September, 2012.
- Belmonte, J., E. Cuevas: *Proyecto EOLO-PAT. Estudio de alérgenos en Canarias. Resumen anual de datos 2012*. Bellaterra: Proyecto EOLO-PAT, 2013.
- De Linares, C., Delgado, R., Aira, M.J., Alcázar, P., Alonso-Pérez, S., Boi, M., Cariñanos, P., Cuevas, E., Díaz de la Guardia, C., Elvira-Rendueles, B., Fernández-González, D., Galán, C., Gutiérrez-Bustillo, A.M., Pérez-Badia, R., Rodríguez-Rajo, F.J., Ruiz-Valenzuela, L., Tormo-Molina, R., Trigo, M.M., Valencia-Barrera, R.M., Valle, A., Belmonte, J. *Changes in the Mediterranean pine forest: pollination patterns and annual trends of airborne pollen*. *Aerobiologia*, 33: 375-391, 2017.
- Galán, C., Ariatti, A., Bonini, M., Clot, B., Crouzy, B., Dahl, A., Fernandez-González, D., Frenguelli, G., Gehrig, R., Isard, S., Levetin, E., Li, D.W., Mandrioli, P., Rogers, C.A., Thibaudon, M., Sauliene, I., Skjoth, C., Smith, M., Sofiev, M. *Recommended terminology for aerobiological studies*. *Aerobiologia*, 33: 293-295, 2017.

14.6 Staff

- Dr Jordina Belmonte (UAB; Head of programme)
- Dr Emilio Cuevas (AEMET; Co-PI)
- Ramón Ramos (AEMET; Hirst sampler maintenance)
- Sergio Afonso (AEMET; Sampling)
- Virgilio Carreño (AEMET; Sampling)
- Rut Puigdemunt (UAB; Technical Analyst)
- David Navarro (UAB; Technical Analyst)
- Dr Concepción De Linares (UAB; Research Scientist)
- Cándida Hernández (AEMET; Meteorological Observer-GAW Technician)
- Concepción Bayo (AEMET; Meteorological Observer-GAW Technician)

15 Phenology

15.1 Main Scientific Goals

Phenology is the study of biological phenomena that occur periodically coupled to weather-related seasonal rhythms and to the annual course of the weather, in a particular place. These phenomena (migratory birds' phases, appearance of flowers or fruit ripening in plants, etc.) are sensitive to changes in weather and climate; hence, its detailed study may help better understand how these environmental variations affect living things. Therefore, WMO recommended to the National Meteorological Services to implement a phenological observations programme.

IZO is an excellent location for conducting phenological observations since it is located in a high mountain area on an island with a large number of endemic species. The endemic species are adapted to specific environmental conditions, which make them particularly sensitive to small environmental changes, and therefore their study is of great interest.

AEMET has operated a programme of phenological observations since the 1940s, but its focus has been largely on agricultural applications. However, in 2014 IZO joined AEMET's network of phenological stations in order to better understand the relationship between the life cycles of endemic wildlife of the environment and the specific and unique climate of the area. The programme started in collaboration with the Teide National Park authority.

The programme of phenological observations at IZO was established with the commitment to maintain long-term observations; we can only obtain valuable information if observations are performed systematically for many years. The clearest examples are the climatological observations.

15.2 Measurement Programme

Currently we are studying the taxa shown in (Fig. 15.1), all of them endemic, corresponding to the higher elevations of the island of Tenerife. We study, for each taxon, the emergence of the inflorescence, or the appearance of flower buds, flowering, and fruit development according to the BBCH code (Biologische Bundesanstalt, Bundessortenamt und Chemische Industrie) adopted by AEMET. The phenological stages that are taken into account are detailed in Table 15.1.

We also employ another encoding (Table 15.2), used by the experts of the Teide National Park and based on the model proposed by Anderson and Hubricht (1940) within the joint phenological project with this institution. In this methodology, three biological phases (inflorescence emergence or development of flower buds; flowering and

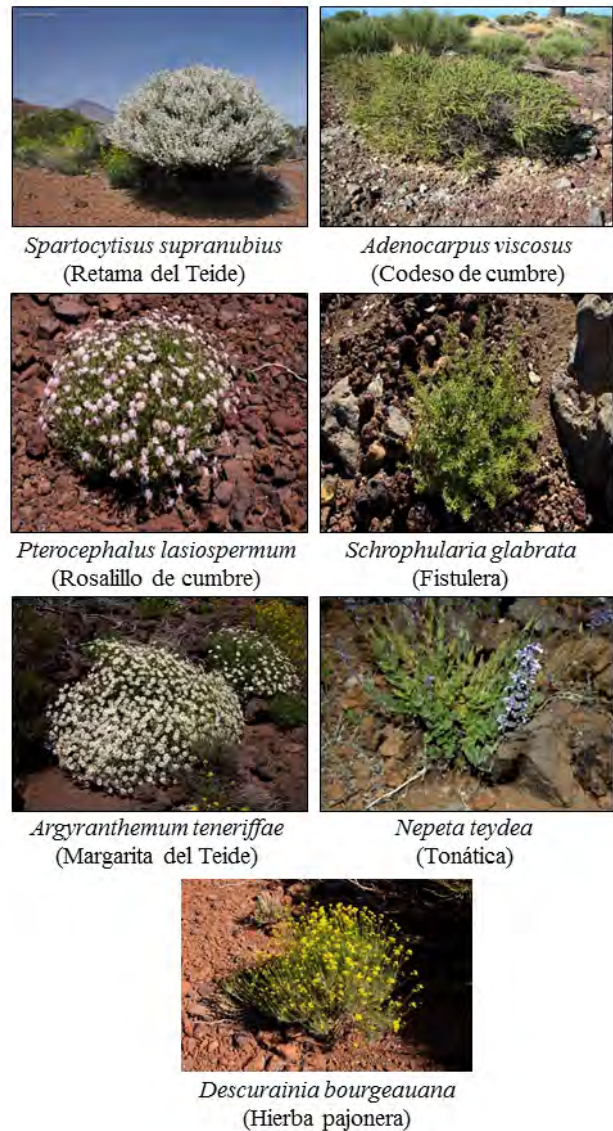

Figure 15.1. Endemic taxa typical from high lands of the island of Tenerife, which are analysed in the Phenology programme.

fruit development) and their percentage in the population development of each taxa are considered. Phenological observations are visual, so we chose nine sampling points around IZO where there is a good representation of healthy adult specimens of the studied taxa. For each observation point we estimate the percentage of phenological phases, translating this percentage to the aforementioned codes. The selected sampling points are marked in Fig. 15.2.

The phenological observations are made on a weekly basis at the time of the appearance of buds, flowering and fruit growth and every fortnight in pre- and post-development weeks of these stages, and on a monthly basis during the winter months.

Table 15.1. Phenological stages: BBCH code.

BBCH code	Description
551	10% of visible petals closed, 10% “tip petals”
55	Emergence of the corolla, visible petals closed, "tip petals"
60	First flowers open
61	10% of flowers open (beginning of flowering).
63	Flowering to 30%
65	Bloom 50% (full bloom)
79	End of fruit formation (practically reach their final size)
89	The fruits are mature; They detach easily from the plant

Table 15.2. Phenological stages: Anderson & Hubricht code.

Code	Description (valid for each stage: inflorescence, flowering and fruit)
A	Absent
B	From the first specimens up to 10%
C1	from 10 to 30% of buds / flowers / fruits
C2	Between 30 and 50%
D	More than 50%
E1	Between 50 and 30%
E2	Between 30 and 10%
F	Less than 10% of specimens



Figure 15.2. Aerial view of the surroundings of the Izaña Atmospheric Observatory indicating the selected sampling points, those on the north-west slope are marked in blue and those on the south-east slope are marked in yellow.

15.3 Summary of results during 2017

The observations, shown here for 2017 (Fig. 15.3), allow us to distinguish different patterns of flowering in the studied species: while some remain in full bloom for many weeks (as in the case of the Daisy flower, *Argyranthemum teneriffae*), other species have a more explosive flowering, probably adapting to the few days when environmental conditions are favourable to do so without too much heat or

cold, and the ground still wet. From the flowering data for 2017, it is noteworthy that the "Retama del Teide" (*Spartocytisus supranubius*) and "Rosalillo de Cumbre" (*Pterocephalus lasiospermum*) did not reach 50% of the flowering. This is something that was also observed in 2012 (a dry and warm year) although in this year the systematic phenological counts had not yet begun. The causes are being investigated but are related to the temperature and precipitation of those years. Unfortunately, due to the lack of Meteorological observers at Izaña Observatory in 2018, the phenological observations were interrupted during this year.

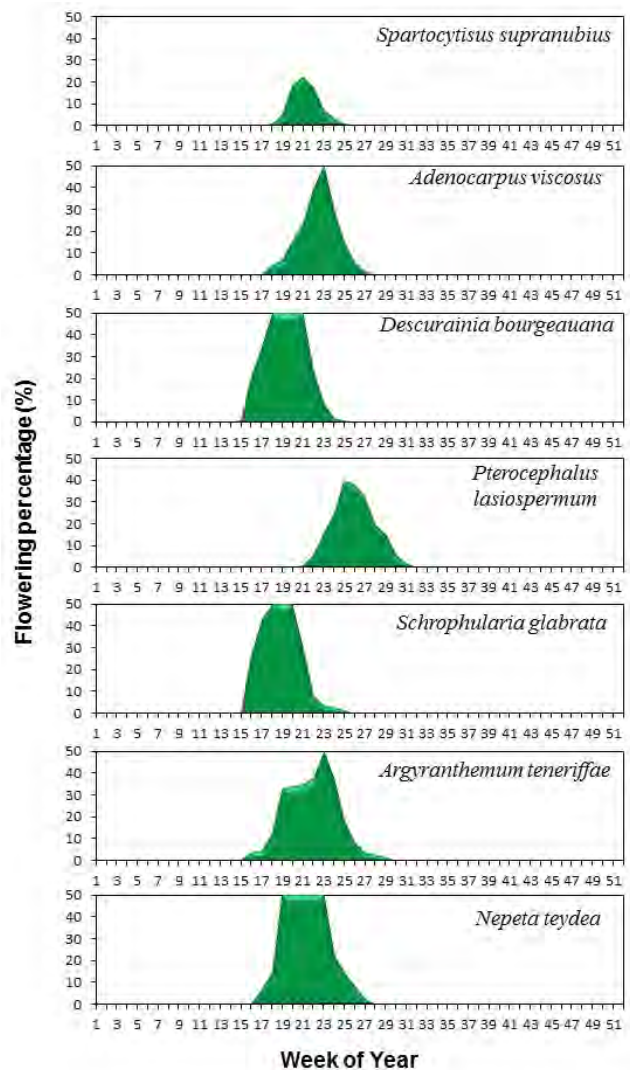

Figure 15.3. Duration of the flowering stage in different taxa at Izaña, 2017.

15.4 Development of a gauge for measuring the water from fog

In the summits of Tenerife the annual precipitation is around 430 mm, but there are large inter-annual variations. Fog is thought to provide a significant additional contribution of water to vegetation in drought years, as the vegetation is able to capture some of the water contained in the fog droplets. In order to have data on the amount of water that

can be obtained from the fog, a rain gauge was adapted following the guidelines of the WMO technical note (2008) and installed in 2009. The gauge comprises a metal mesh above a cylinder of 10 cm diameter and 22 cm height, and a frame of 0.2 cm x 0.2 cm, which mimics the capture of fog droplets by the plants, although we assume this is quite difficult to achieve because much depends on the leaf morphology, orientation of the plant, wind, etc. The adapted rain-gauge and a close-up of the wire mesh installed are shown in Fig. 15.4.

15.6 Staff

Rubén del Campo Hernández (AEMET; Head of programme) now at AEMET Head Office, Madrid

Candida Hernández Hernández (AEMET; Meteorological Observer-GAW Technician)

Ramón Ramos (AEMET; Head of Infrastructure)

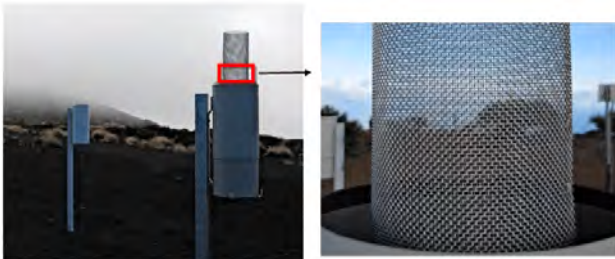

Figure 15.4. Adapted rain-gauge and a close-up of the wire mesh.

The results obtained so far show that the contribution of water due to the fog is important, since the rain gauge adapted for the collection of fog-water collected approximately 5 times more precipitation than the conventional rain gauge (Fig. 15.5). Also noteworthy is the extremely dry period 2011-2012, in which the total water collected by the fog gauge was almost 13 times higher than the standard gauge. Note that the hydrometeorological period of 2017-2018 shows the maximum of fog precipitation (2750 mm) during the 2009-2018 series.

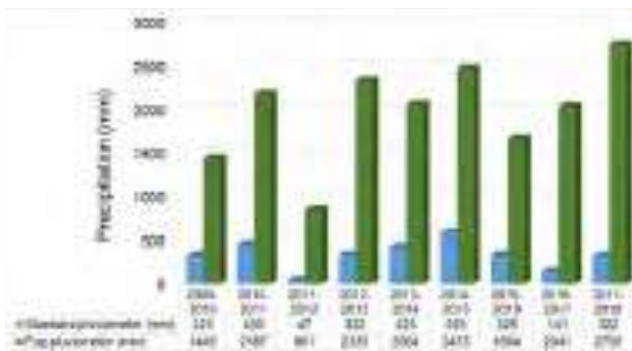

Figure 15.5. Comparison of the precipitation collected with standard rain gauge and the modified fog-rain gauge for the last nine hydrometeorological years. The ‘hydrometeorological year’ used here is the period from September 1 to August 31.

15.5 References

Anderson, E and Hubricht, L, A method for describing and comparing blooming seasons, Bulletin of the Torrey Botanical Club, 639-648, 1940.

WMO, Guide to Meteorological Instruments and Methods of Observation, WMO, N° 8, Seventh edition, 2008.(accessible at http://www.wmo.int/pages/prog/gcos/documents/gruanmanuals/CIMO/CIMO_Guide-7th_Edition-2008.pdf)

International Cooperation Programmes

16 ACTRIS

ACTRIS (Aerosol, Clouds and Trace Gases Research Infrastructure) is a pan-European initiative consolidating actions amongst European partners producing high-quality observations of aerosols, clouds and trace gases. Different atmospheric processes are increasingly in the focus of many societal and environmental challenges, such as air quality, health, sustainability and climate change. ACTRIS aims to contribute in the resolving of such challenges by providing a platform for researchers to combine their efforts more effectively, and by providing observational data of aerosols, clouds and trace gases openly to anyone who might want to use them.

During 2015-2019 the coordination of ACTRIS has been supported by two different EC-projects; ACTRIS-2 and ACTRIS Preparatory Phase Project (PPP). The former revolved around on-going research, coordinating efforts of partner organisations and producing observations and data, while the latter is a project aiming to establish a research infrastructure with its own legal entity and operational structure that will carry on the work done by ACTRIS-2.

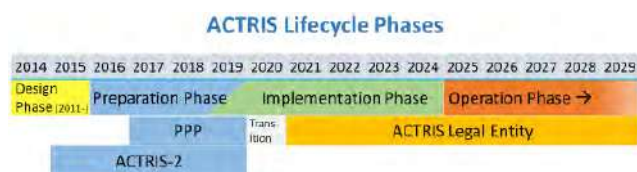

Figure 16.1. ACTRIS lifecycle phases from design to preparation, implementation and operation.

ACTRIS is composed of European level Central Facilities and distributed National Facilities (Observational platforms and Exploratory platforms). The European level Central Facilities include the Head Office, the Data Centre and six Topical Centres (TC) (see Fig. 16.2). ACTRIS TCs are or will be organized around the main scientific themes of ACTRIS: aerosol, clouds, and reactive trace gases, each with a particular focus on either remote sensing or in situ measurement techniques.



Figure 16.2. ACTRIS research infrastructure core components.

The key services and operation support provided by the TCs are: a) procedures and tools for quality assurance and quality control of ACTRIS measurements and data; b) transfer of knowledge and training to ACTRIS operators and users, and c) improvements of measurement methodologies for aerosol, clouds, and reactive trace gases. The TCs should operate at the state-of-the-art, fostering the implementation of validated new techniques in ACTRIS. To sustain a high level of performance and to stimulate the advancement of new techniques and methodologies, the TCs contribute to expert collaboration networks.

16.1 Centre for Aerosol Remote Sensing

The Centre for Aerosol Remote Sensing (CARS) is one of the six Topical Centres and will consist of topical units hosted by the following institutions:

- 1) National Institute of Research and Development for Optoelectronics (INOE), Romania.
- 2) Meteorological Institute of the Ludwig-Maximilians-University (LMU-MIM), Germany.
- 3) Consiglio Nazionale delle Ricerche (CNR), Italy.
- 4) Hohenpeissenberg Meteorological Observatory, Deutscher Wetterdienst (DWD), Germany.
- 5) CNRS-Laboratoire d'Optique Atmosphérique, Lille University, France.
- 6) Izāna Atmospheric Research Center (AEMET), Spain.
- 7) University of Valladolid (UVA), Spain.

The Centre for Aerosol Remote Sensing will offer operation support and services for the following ACTRIS variables and measurement techniques (Fig. 16.3).

ACTRIS variables	Measurement techniques
<ul style="list-style-type: none"> • Attenuated backscatter profile • Volume depolarization profile • Particle backscatter coefficient profile • Particle extinction coefficient profile • Lidar ratio profile • Ångström exponent profile • Backscatter-related Ångström exponent profile • Particle depolarization ratio profile • Particle layer geometrical properties (height and thickness) • Particle layer optical properties (extinction, backscatter, lidar ratio, Ångström exponent, depolarization ratio, optical depth) • Column integrated extinction • Planetary boundary layer height • Spectral Downward Sky Radiances • Direct Sun/Moon Extinction Aerosol Optical Depth (column) 	<ul style="list-style-type: none"> • Aerosol high-power aerosol lidar • Automatic low-power aerosol lidar and celometers • Automatic sun/skylunar photometer

Figure 16.3. ACTRIS variables and measurement techniques supported by the Centre for Aerosol Remote Sensing.

In 2016, the European Strategy Forum on Research Infrastructures (ESFRI) selected ACTRIS as a new Research Infrastructure (RI) on its [roadmap](#) encouraging ACTRIS implementation within a 10-year time frame. The ACTRIS Preparatory Phase Project (EU-H2020 project) supports the RI development and is funded until December 2019. ACTRIS is now in the Preparation Phase and will move into the Implementation Phase in 2020 and plans to be fully operational in 2025 (Fig. 16.1). The ACTRIS Implementation Phase Project (IMP) was approved for funding by the European Commission (INFRADEV-3 call) in August 2019 for a four year period (2020–2023).

16.2 ACTRIS-2 (AERONET-EUROPE Calibration Service)

The project ACTRIS-2 Integrating Activities (IA) received funding from the European Union’s Horizon 2020 research and innovation programme for four years (1 May 2015 - 30 April 2019) after the successful completion of the first ACTRIS IA in FP7 project (2011-2015).

ACTRIS-2 addressed the scope of integrating state-of-the-art European ground-based stations for long-term observations of aerosol, clouds and short-lived gases. ACTRIS-2 ran in parallel to the ACTRIS Preparatory Phase Project. The main activities in ACTRIS-2 were related to providing TransNational Access (TNA) for users, strengthening the measurement and calibration capabilities, and developing data comparability and data life-cycles. ACTRIS-2 facilitated the improvement of the technical level of planned RI services, enhanced RI collaboration on a national, regional, and global scale, and encouraged public-private partnerships and collaboration.

The AERosol RObotic NETwork ([AERONET](#)) is a ground-based standardized automatic sun/sky-photometer network devoted to the characterization and monitoring of aerosol properties. AERONET sites are located worldwide, with also a high number in Europe. AERONET is one of the facilities available worldwide to satellite and atmospheric modelling communities to verify and validate both near real time and long-term aerosol products. It was widely used in the various Monitoring Atmospheric Composition and Climate (MACC) projects and in the current Copernicus Atmosphere Monitoring Service ([CAMS](#)). AERONET is also used by the Climate Change Initiative (CCI) and the WMO Sand and Dust Storm Warning Advisory and Assessment System ([SDS-WAS](#)) for Northern Africa, Middle East and Europe.

Until April 2019, the [AERONET-EUROPE Calibration Service](#) was financed by the project ACTRIS-2 Integrating Activities. AERONET-EUROPE Calibration Service offers to the scientific community a unique sun-photometer facility for calibration and maintenance, operating within the AERONET federation (Goloub et al., 2015; 2016a,b; 2017). Since 2015, one additional value from AERONET-

EUROPE Calibration Service is providing lunar calibration and nighttime AOD from the new Triple photometer (Cimel CE318T; for sun, sky and lunar observations).

This TransNational Access handles a calibration service for instruments operated at current and future AERONET sites, thus, complementing the NASA calibration center based in Washington-USA. AERONET-Europe Calibration Service is a multi-site infrastructure (Fig. 16.4) with facilities at Lille (LOA, France) and Valladolid (GOA, Spain), devoted to inter-calibration of field instruments, and at IZO, a unique facility for absolute calibration of Master Cimel instruments.

IZO hosts a set of eight reference instruments continuously in operation and available for the needs of the LOA and GOA facilities. AERONET-EUROPE master instruments from LOA and GOA are recalibrated every three months at IZO in order to assure measurement accuracy.

Master instruments from other networks such as the China Aerosol Remote Sensing NETwork (CARSNET) and the Institute of Remote Sensing Applications (IRSA) are also recalibrated at IZO on a regular basis.



Figure 16.4. Location of the three calibration facilities of AERONET-Europe.

At the end of 2017, the AERONET-Europe facility at Izaña was expanded and improved for covering the increasing calibration needs. New power supply and data transfer systems were implemented as well as new docking and weatherproof cases were installed. Furthermore the wiring system was fixed to facilitate the frequent installation and uninstallation of the instruments for calibration. Currently, 20 photometer calibrations can be performed at the same time (see Fig. 16.5).



Figure 16.5. Cimel Masters at the Izaña Atmospheric Observatory AERONET-Europe Calibration facility.

All users operating for their research activity either a standard or a polarized CIMEL sun/sky or triple (sun/sky/lunar) photometer located in Europe or run out of Europe in the framework of international cooperation agreements can submit a proposal to AERONET-EUROPE Calibration Service at any time. The instrument calibration and maintenance is performed free of charge, and proposals are granted on the basis of a TNA selection panel review process. Instrument shipping expenses from and to the user site are not included and must be covered by the user institution.

Most of the accesses provided under AERONET-EUROPE allow to assure quality of data on sites operating not only a sun or triple photometer but also multiple complementary in situ and remote sensing instruments. This aspect provides a clear integration of sun or triple photometers, LIDARs and in situ aerosol instruments. The number of total accesses provided by AERONET-EUROPE in 2017-2018 was 222, specifically 104, 80 and 38 for LOA, GOA and IZO, respectively.

In addition to the calibration activity provided by AERONET-EUROPE to European users for European sites, several accepted proposals involved European users deploying their instruments during either field experiments or in a more permanent manner out of Europe, for example, in Northern Africa, South East-Africa, Central Asia, Asia and Antarctica. These calibrations also provided a good opportunity for linking the AERONET network to other sun or lunar photometer networks operating or starting operation in the world. Several proposals involved other existing technologies and new technologies under evaluation.

Data quality, instrument performance and well-trained site managers are, after calibration, the keys of success to be considered by AERONET-EUROPE. Thanks to these activities, several sites/instruments previously managed/calibrated by NASA and insufficiently managed by the users, have been renovated.

Quality-assured data from AERONET-EUROPE are widely used by modelling and satellite communities through

several European programs and initiatives (ESA, MACC-II, GMES, AEROCOM, etc). By the end of 2018, around 40 AERONET sun-photometers were used for near real time validation by the SDS-WAS Regional Center for North Africa, Middle East and Europe, most of them were calibrated by AERONET-EUROPE. CAMS also performs near real time use of AERONET data for specific model aerosol products verification.

16.3 TransNational Access

The ACTRIS-2 project offers free of charge hands-on access of researchers to 18 world-class observing platforms in Europe within the transnational access (TNA) programme. The observational facilities offering TNA are representative for their uniqueness within Europe, offering a comprehensive measurement programme at the forefront of the advancement of research in the specific domains covered within ACTRIS (e.g. vertical aerosol distribution, in-situ aerosol properties, trace gases) together with state-of-the-art equipment, high level of services, and capacity to provide research-driven training to young scientists and new users.

One of these 18 observational facilities is the Izaña Atmospheric Research Center under the acronym of ISAF (Izaña Subtropical Access Facility). ISAF is the only existing infrastructure for observations in the free troposphere of the subtropical North Atlantic. Three TNA types are available: 1) training, 2) mobility of expert and 3) combination of training/expert mobility. In the period 2017-2018, five TNA proposals to ISAF were applied for and approved.

16.3.1 TNA 16-20 January 2017

Mr Lahouari Zeudmi was the first technician from the Office National de la Météorologie-Tamanrasset station (Algeria) that applied for a training access to ISAF. Tamanrasset site is a WMO-GAW station located in a strategic site, in the core of the Sahara. Continuous training of the technicians at the station is essential to assess the quality assurance (QA) and quality control (QC) of their

total column aerosol program. From 16 to 20 January, he attended to an intensively 20-hour training course on Cimel sun-photometer operation given by Dr. Carmen Guirado-Fuentes. Main course topics included training on practice with sunphotometers, AERONET calibration system, measurements and derived products; CAELIS alert system; atmospheric aerosol generalities; and data analysis.



Figure 16.6. Lahouari Zeudmi undertaking training activities during his TNA, 16-20 January 2017.

16.3.2 TNA 7-14 February 2017

This TNA involved the mobility to ISAF of the expert Mr Philippe Demoulin (Royal Belgian Institute for Space Aeronomy). He was testing and calibrating the VISION instrument, a miniature visible and near-infrared imaging spectrometer that will fly on-board PICASSO (Pico-Satellite for Atmospheric and Space Science Observations), a CubeSat spacecraft to be launched during 2017. During the access, more than 6000 solar images were recorded, in spite of certain occasional fog.



Figure 16.7. Philippe Demoulin during his TNA, 7-14 February 2017.

16.3.3 TNA 3-7 April 2017

Mr Ilyes Zarrouk has been the only technician from the Institut National de la Météorologie de Tunisie - Tunis_Carthage station (Tunisia) that applied for a training access to ISAF. Tunis_Carthage is a key station for monitoring dust storms travelling to the Mediterranean, for validating regional and global dust models as well as for validating satellite-based dust measurements. The training course reinforced their relatively new total column aerosol program.

During his stay at Izaña, Mr Ilyes Zarrouk attended an intensive 20-hour training course on Cimel sun-photometer operation given by Dr Carmen Guirado-Fuentes and Mr Ramón Ramos. Main course topics included training on practice with sunphotometers; AERONET calibration system, measurements and derived products; CAELIS alert system; and data analysis.



Figure 16.8. Ilyes Zarrouk during his TNA, 3-7 April 2017.

16.3.4 TNA 1-9 June 2017

Dr Mauro Mazzola (National Research Council of Italy, Institute of Atmospheric Sciences and Climate, CNR-ISAC) participated as an expert in the "Lunar Photometry Campaign and Workshop at Izaña 2017". The TNA was devoted to test the Lunar version of the Precision Filter Radiometer (PFR), produced by PMOD-WRC (Physikalisch-Meteorologisches Observatorium Davos - World Radiation Center). The PFR Lunar prototype, developed in collaboration between PMOD-WRC and CNR-ISAC, was calibrated and compared with other instruments suitable for retrieving aerosol optical depth using the light reflected by the Moon, including the reference instrument CE318T photometer, manufactured by Cimel Electronique.



Figure 16.9. Dr Mauro Mazzola during his TNA, 3-7 April 2017.

16.3.5 TNA 25-29 June 2018

Mr Sidalamine Baika was the second technician from the Office National de la Météorologie-Tamanrasset station (Algeria) that applied for a training access to ISAF. The objective was to keep a continuous annual training of the technicians from this station, providing active support to

their monitoring programs that cover a lack of atmospheric measurements in the Sahara. This TNA was the last one belonging to non-EU users, reaching the 20% quota for non-EU users of the total accesses.



Figure 16.10. Sidalamine Baika during his TNA, 25-29 June 2018.

16.4 References

- Goloub, P., E. Cuevas, C. Toledano, AERONET-EUROPE Central Facility Calibration/Maintenance Service for Sun/Moon/Sky-Photometry Devoted to Aerosols, Water Vapor and Clouds characterization, ACTRIS II stakeholders meeting, February 27, 2015.
- Goloub, P., C. Toledano and E. Cuevas, Calibration/Maintenance/QC/QA Service for Sun/Moon/Sky-photometry: Aerosols, Water Vapor and Clouds characterization, ACTRIS, ACTRIS RI planning meeting, Bad Zurzach, Switzerland, 26 – 28 January, 2016a.
- Goloub, P., C. Toledano and E. Cuevas, The European AERONET Calibration Facility: Updates within ACTRIS-2 and New dimension in ACTRIS-RI, 2nd ACTRIS-2 General Meeting, Frascati, Italy, Feb 29-Mar 3, 2016b.
- Goloub, P., C. Toledano, E. Cuevas, WP7: AERONET-Europe, ACTRIS-2 Mid-time Review Meeting, Granada, Spain January 31, 2017.

16.5 Staff

- Dr Emilio Cuevas (PI of Izaña-AEMET facility)
- Dr Carmen Guirado Fuentes (UVA/AEMET; Research Scientist) left IARC in September 2019
- Dr Philippe Goloub (PI of LOA-CNRS/University of Lille facility)
- Dr Carlos Toledano (PI of GOA-University of Valladolid facility)



17 Regional Brewer Calibration Center for Europe (RBCC-E)

17.1 Background

In November 2003 the WMO/GAW Regional Brewer Calibration Center for Europe (RA-VI region) (RBCC-E) was established at IZO. The RBCC-E reference is based on three double Mark-III Brewer spectrophotometers (the IZO triad): a Regional Primary Reference (Brewer 157), a Regional Secondary Reference (Brewer 183) and a Regional Travelling Reference (Brewer 185) (Fig. 17.1). As described in Section 3.1, IZO is located in a subtropical region (28°N) on a mountain plateau (2373 m a.s.l.) with pristine skies and low ozone variability. This location allows routine absolute calibrations of the references in similar conditions to the Mauna Loa Observatory (MLO), Hawaii, USA. The establishment of the RBCC-E Triad allows the implementation of a self-sufficient European Brewer calibration system that respects the world scale but works as an independent GAW infrastructure.

There are two European Calibration Centers for the two types of ozone spectrophotometers in use: Dobson and Brewer. The Regional Dobson Calibration Center for Europe (RDCC-E) is located at the Meteorological Observatory Hohenpeissenberg (Germany). Since 2009, the RBCC-E activities have largely been funded by the ESA project, “CEOS Intercalibration of Ground-Based Spectrometers and Lidars” which includes the participation of the two European Calibration Centers (RBCC-E and RDCC-E).

17.2 Objectives

The main objectives of this Cooperation programme are:

- To implement a system for routine absolute calibrations of the European Brewer regional reference instruments at IZO, fully compatible with absolute calibrations of the world reference triad at MLO.
- To perform periodical calibration campaigns using the Regional Primary Reference B157 (during intercomparisons held at IZO) and the Regional Travelling Reference B185 spectrophotometer (traceable to B157) in continental campaigns.
- To perform regular comparisons of the Regional Brewer Primary Reference B157 with the Regional Dobson Reference D074 to monitor the relationship between both calibration scales in the RA-VI region.
- To study the sources of errors of the absolute calibrations and to determine the accuracy of total ozone measurement achievable by the Brewer spectrophotometer under different atmospheric conditions or instrumental characteristics.



Figure 17.1. The RBCC-E team on its way to the El Arenosillo 2017 campaign (Photo: Sergio F. León Luis).

17.3 Tasks

The main tasks of this Cooperation programme are:

- To develop quality control procedures and Standard operating Procedures (SOPs) for traceability of measurements to the reference standards.
- To maintain laboratory and transfer standards that are traceable to the reference standards.
- To perform regular calibrations and audits at GAW sites.
- To provide, in cooperation with Quality Assurance/Science Activity Centres, training and technical assistance for stations.

17.4 GAW Scientific Advisory Group for Ozone

The GAW Scientific Advisory Group for Ozone (GAW SAG Ozone) monitors the activities in the stratospheric ozone programme, overlooks and gives guidance to the World Ozone and UV Data Centre and the Calibration Centres, and establishes and helps publish standard operating procedures. In addition, it helps with capacity building activities, makes recommendations about measurement techniques, calibration schedules and relocation of redundant instruments, and provides recommendations for all participants of the Ozone Network. The group consists of 19 international experts. Alkiviadis Bais (Greece) has been the chair of the GAW SAG Ozone since 2013. Alberto Redondas (IARC) as site manager of the RBCC-E has been a member of the GAW SAG Ozone since 2005.

17.5 Main activities of the RBCC-E during the period 2017-2018

17.5.1 Absolute calibration transfer

The RBCC-E Brewer triad transfers the calibration from the world reference triad, located in Toronto (Canada) and managed by Environment and Climate Change Canada, Meteorological Service of Canada (ECCC-MS). The RBCC-E travelling reference Brewer#185 ensures the world reference transference to the WMO-Region VI Brewer network. The link of the RBCC-E triad to the world reference has been performed in the past using the travelling standard Brewer#017 managed by the International Ozone Service (IOS). The WMO GAW SAG ozone in 2011 authorized RBCC-E to conduct the transference of its own absolute calibration, based on Langley analysis at IZO. The link to the world reference is by direct intercomparison with the world triad in Toronto or by common Langley campaigns at MLO or at IZO (León-Luis et al., 2018).

At present, the RBCC-E maintains a triad of reference instruments. The Regional Primary Reference Spectrophotometer (B#157), Secondary Reference Spectrophotometer (B#183) and the Regional Travelling Reference Spectrophotometer (B#185). Each spectrophotometer is calibrated independently with the standard Langley method at IZO and since 2011 transfer their own calibration and are regularly compared with the Toronto Triad. Redondas et al. (2018) and León-Luis et al. (2018) studied the stability of the RBCCE triad during the period 2005-2015, using a mathematical method where the ozone values are fitted to a 2nd grade polynomial (Fioletov et al., 2005) or an extended 3rd grade polynomial (Stübi et al., 2017).

Redondas et al. (2018) and León-Luis et al. (2018) took into account two conditions: a) only days with at least 15 measurements distributed between, before and after the solar noon and with standard deviation < 0.5 were selected and b) data from Brewer #185 measured during campaigns were removed. In addition to this study, the stability of the RBCCE triad during the period 2010-2018 is presented in this report. The distribution of the difference between the ozone daily mean obtained by each Brewer with respect to the Triad mean O₃ value (O_{3_mean}) was calculated as follows:

$$O_{3_mean} = (O_{3_157} + O_{3_183} + O_{3_185})/3. \quad (1)$$

A good Gaussian profile can be observed in the distribution of the differences (Fig. 17.2) which confirms the stability of the IZO Brewer Triad during the period 2005-2018.

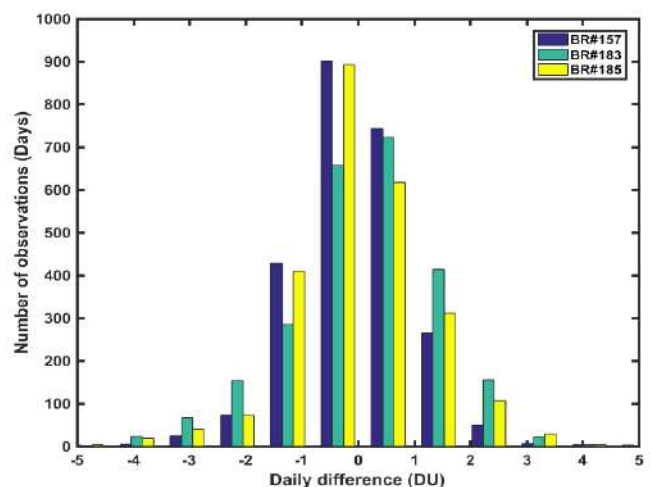

Figure 17.2. Distribution of the differences between the ozone daily mean obtained by each Brewer in the Triad with respect to the mean O₃ value of the RBCC-E Brewer Triad located at IZO for the period 2010-2018.

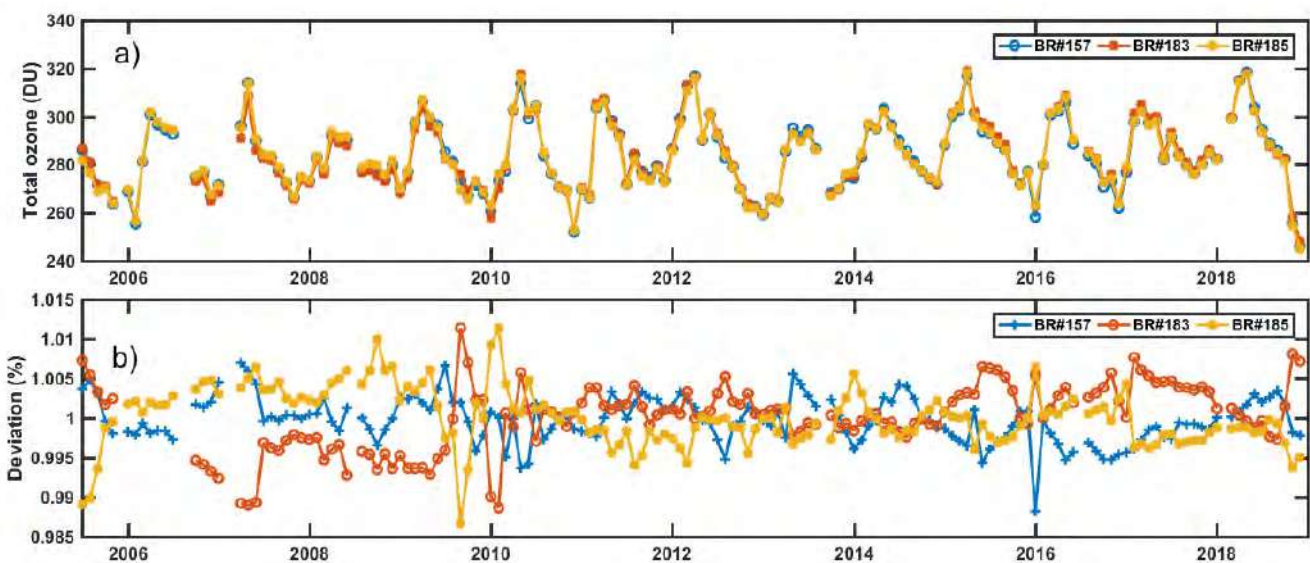

Figure 17.3. a) Monthly mean Total Ozone Column values measured at Izaña Atmospheric Observatory by the RBCC-E triad and b) Total ozone ratio of each Brewer in comparison to the RBCC-E Triad mean during the period 2005-2018.

Figure 17.3 shows the relative deviations from the RBCC-E triad monthly mean TOC for each individual Brewer. This plot is used as a benchmark to identify if an instrument of the Triad needs to be recalibrated or for checking that a current calibration applied to a Brewer is good enough. The standard deviation of the relative deviations from the RBCC-E Triad monthly mean have values of 0.34%, 0.36% and 0.30% (B#157, B#183 and B#185) for the period 2010-2018, slightly lower than those reported for the Canada Triad (Fioletov, et al. 2005).

17.5.2 RBCC-E Intercomparison campaigns



Figure 17.4. The RBCC-E travelling reference Brewer #185 at the Arosa 2018 campaign (Photo: A. Redondas).

Brewer intercomparisons are held annually, alternating between Arosa in Switzerland and the El Arenosillo Sounding Station of the INTA at Huelva in the south of Spain. The aim is for a number of Brewers from invited organizations to collect simultaneous ozone data so that their calibration constants can be transferred from the reference instruments. Two regular intercomparison campaigns were organized by the RBCC-E during this reporting period (2017-2018), the Twelfth RBCC-E intercomparison campaign held at El Arenosillo (Spain, 29 May – 7 June 2017) and the Thirteenth RBCC-E intercomparison campaign held at Arosa (Switzerland, 30 July – 10 August 2018) (Table 17.1).

The geographical origin of the Brewers calibrated by the RBCC-E is shown in Fig. 17.5 and the number of calibrations performed by the RBCC-E every year is shown in Fig. 17.6. In 2017 and 2018, 22 and 7 calibrations were performed, respectively. These routine intercomparison campaigns provide the Brewer community with the opportunity to assess the European network instruments status.



Figure 17.5. Geographical origin of the Brewers calibrated by the RBCC-E.

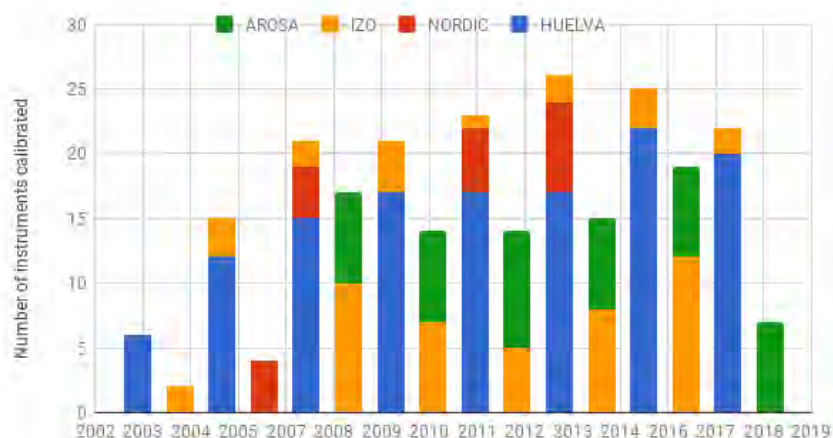

Figure 17.6. Calibrations performed by the RBCC-E per year.

Table 17.1. Campaigns performed during the period 2017–2018 organized by the RBCC-E.

Institution	Participants	Instrument	Country
Arenosillo 2017 (Spain, 29 May – 7 June) RBCC-E			
IARC-AEMET	Alberto Redondas Sergio Leon Virgilio Carreño Francisco Parra Rojas Bentorey Hernández	Brewer #185-MKIII	Spain
University of Thessaloniki	Alkis Bais Fani Gkertsis	Brewer #005-MKII	Greece
International Ozone Services (IOS)	Martin Stanek Volodya Savastiouk	Brewer #017-MKII	Canada
IARC-AEMET	J.M San Atanasio Juan R. Moreta Ana María Díaz Francisco García	Brewer #033-MKIV Brewer #070-MKIV Brewer #117-MKIV Brewer #151-MKIV Brewer #166-MKIII Brewer #186-MKIV	Spain
UK Meteorological Office (UKMO)	John Rimmer	Brewer #075-MKIV Brewer #126-MKII Brewer #172-MKIII	U.K.
Instituto Português do Mar e da Atmosfera (IPMA)	Diamantino Henriques	Brewer #102-MKII	Portugal
Instituto Nacional de Técnica Aeroespacial (INTA)	Jose Manuel Vilaplana	Brewer #150-MKIII	Spain
Kipp & Zonen (K&Z)	Keith M. Wilson Pavel Babal Martjin Van Sebille	Brewer #158-MKIII Brewer #230-MKIII	The Netherlands
World Radiation Center (WRC)	Julian Groebner Natalia Kournemeti Luca Egli	Brewer #163-MKIII QUASUME	Switzerland
Danmarks Meteorologiske Institut (DMI)	Paul Eriksen Niss Jepsen	Brewer #202-MKIII Brewer #228-MKIII	Denmark
Finnish Meteorological Institute (FMI)	Tomi Karpinen	Brewer #214-MKIII	Finland
York University	Tom McElroy		Canada
Denmark	Paul Erikson Niss Jepsen	Brewer #202-MKIII Brewer #228-MKIII	Denmark
Universidad de Extremadura	Antonio Serrano Ana Álvarez Piedehierro Guadalupe Sánchez Hernández		Spain

Institution	Participants	Instrument	Country
Arosa-Davos 2018 (Switzerland, 30 July – 10 August 2018) RBCC-E			
IARC-AEMET	Alberto Redondas Sergio León Luis Virgilio Carreño	Brewer #185-MKIII	Spain
Arosa Lichtklimatisches Observatorium (LKO)	René Stübi Herbert Schill Werner Siegrist	Brewer #040-MKII Brewer #072-MKII Brewer #082-MKIV Brewer #156-MKIII	Switzerland
Kipp & Zonen (K&Z)	Eric Nort Pavel Babal	Brewer #158-MKIII Brewer #245-MKIII	The Netherlands
World Radiation Center (WRC)	Julian Gröbner Luca Egli	Brewer #163-MKIII	Switzerland
Scientific and Production Association “Thyphoon” (RPA)	Vadim Shirotov	Brewer #044-MKII	Russia
York University	Tom McElroy		Canada



Figure 17.7. The 12th RBCC-E intercomparison campaign held at El Arenosillo, 29 May – 7 June 2017.

17.5.3 Intercomparison Results

In the 13th RBCC-E Intercomparison Campaign, the initial comparison (blind period), using the instruments' original calibration constants, showed that all of the operational Brewer instruments were in the $\pm 1.0\%$ range if we consider the stray light free region ($OSC < 900$), while 63% (5 instruments) showed a perfect agreement of $\pm 0.5\%$ after two years calibration period (Figure 17.8).

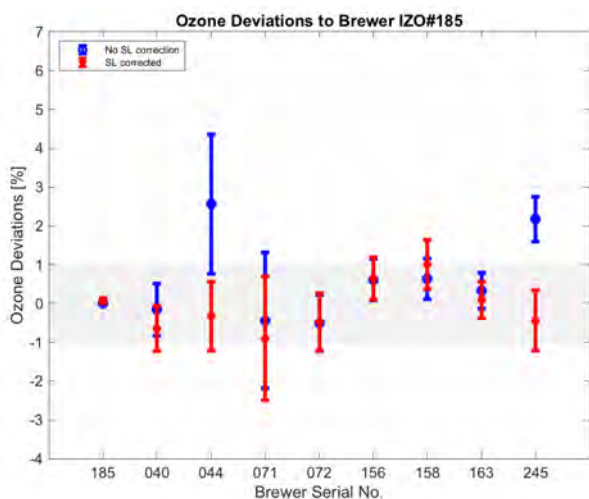

Figure 17.8. Initial period percentage mean difference for the simultaneous direct sun measurements with the reference for all the participating instruments, with and without the standard lamp correction, in the stray-light free OSC region ($OSC < 900$). Reprinted from Redondas et al. (2018).

It is worth noting that these results are obtained without the Stray Light correction. Large errors of up to 4% can be expected for single-monochromator Brewer instruments operating at $OSC > 1000$ DU. After the implementation of the Stray Light correction the single monochromator Brewers improved their performance and with the final calibration, all participating Brewer spectrophotometers were within the $\pm 0.5\%$ agreement range (Figure 17.9).

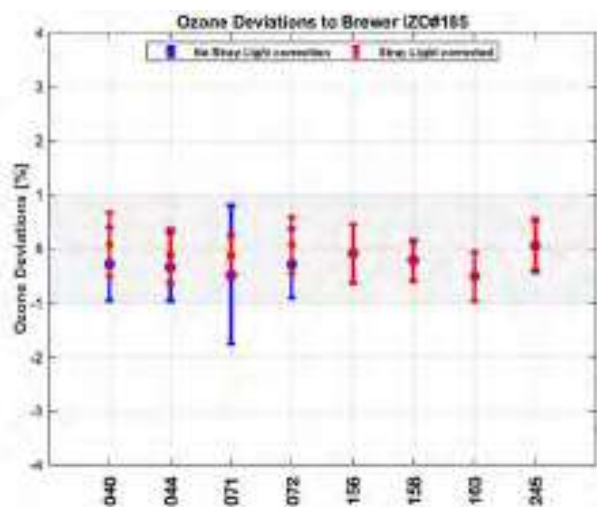

Figure 17.9. Final period percentage mean difference for the simultaneous direct sun measurements with the reference for all the participating instruments. Reprinted from Redondas et al. (2018).

17.5.4 Python interpreter for the Brewer control software

This interpreter proposed by José Rodríguez as part of the activities of the ACTION COST ES1207 EUBREWNET, has as main objective to develop a python interpreter for GWBASIC, to allow to run the Brewer operative software in different operating systems, without the actual limitation of using it only in 32 bits windows versions. With an open access to the source code of the project, it is opened the door to a wide variety of modifications and customizations, that allows the development of new experimental routines, and intercommunicate the brewer software with other applications.

Daniel Santana and Néstor Morales have developed this project with the collaboration of the RBCC-E members, Alberto Redondas, Sergio León, Virgilio Carreño and Dr Manuel Rodríguez Valido as the coordinator of the Industrial Engineering Smart sensor department of La Laguna University and with the collaboration of Sieltec company.

The project took as a starting point an already existing GWBASIC interpreter, made by Rob Hagemans (PCBASIC), in which in a collaborative way the source code was modified to allow a proper communication with the Brewer spectrophotometers, using modern computers with 64bits processors.

The code of the resulting project, called PCBRW, is open source which allows a wide variety of research possibilities such as the possibility of intercepting the communications between the instrument and the interpreter, run python routines from the BASIC code, and interconnect the brewer software with other applications. For more detailed instructions, please see the info in the PCBRW repository: <https://github.com/Danitegue/PCBRW>

17.5.5 Training activities

The RBCC-E, in conjunction with WMO/UNEP and the EUBREWNET action are involved in training and capacity building, by organizing operator courses and workshops which provide expert instruction and knowledge exchange using the considerable expertise available. We also actively support the monitoring programs in developing countries. There have been various training activities during the 2017-2018 period (see below).

ATMOZ Final Workshop during 12th RBCC-E Calibration Campaign, Huelva, 2 June 2017

The final workshop of the European Metrology Research Programme (EMRP) ATMOZ Joint Research Project was held at El Arenosillo during the 12th RBCC-E Calibration Campaign. This workshop summarized the results of the project, whose main objective was to improve characterisation and calibration of the Dobson and Brewer

instruments, particularly by involving the reference instruments of each network, in order to explain the differences of worldwide monitoring total column ozone from the Earth's surface with different instrument types.



Figure 17.10. Participants of the ATMOZ Final Workshop during the 12th RBCC-E Calibration Campaign, Huelva, 2 June 2017.

6th WMO-GAW Brewer operator course, Sydney, Australia, 4-9 September 2017

The event was hosted by the Bureau of Meteorology in Sydney, Australia, from 4-9 September 2017. The training school was focused on operational, scientific and technical issues of the Brewer instrument. The Brewer ozone Spectrophotometer is widely used throughout the world for ground based total ozone column measurements and can also provide solar spectral UV, Aerosol Optical Depth, NO₂ and SO₂ data, plus ozone vertical profiles from Umkehr measurements. The training course, which was mainly practical, covered the topics of basic operation of the Brewer instrument and data reduction.



Figure 17.11. Participants of the 6th WMO-GAW Brewer operator course, Sydney, Australia, 4-9 September 2017.

17.6 Tribute to Ken Lamb

In these pages we would like to pay a sincere tribute to our dear friend Ken Lamb, who passed away on 25/5/2017. Ken Lamb installed and calibrated the first Brewer in 1991 and since then he has accompanied us regularly calibrating our Brewer and collaborating with the RBCC-E since its establishment in 2003. He always helped us in the most difficult moments, and this Calibration center would never have existed without his help, support and teachings. We will always remember him; Ken Lamb was first and foremost a good person willing to help in every situation.



Figure 17.12. Ken Lamb and Alberto Redondas (photo by Geir Braathen).



Figure 17.13. Herber Schill, Ken Lamb, Juanjo Rodríguez, Julian Groebner, Martin Stanek, Bonawentura Rajewska-Wiech, Janusz Jaroslawski, Rene Stuevi and Alberto Redondas during the first Arosa campaign, 2008.



Figure 17.14. Alberto Redondas, Carmen Guirado, Jorge Celso, Jose Maria Fernandez, and Ken Lamb during a calibration of the Izaña Brewer at IZO.

17.7 References

- Fioletev, V.E., Kerr J.B., McElroy C.T., Wardle D.I., Savastiouk V., Granjkar T.S., The brewer reference triad, *Geophys. Res. Lett.*, 32 L208805. 2005.
- León-Luis, S. F., Redondas, A., Carreño, V., López-Solano, J., Berjón, A., Hernández-Cruz, B., and Santana-Díaz, D., Internal consistency of the Regional Brewer Calibration Centre for Europe triad during the period 2005--2016. *Atmos. Meas. Tech.*, 11, 4059-4072, 2018.
- Redondas, A., Carreño, V., León-Luis, S. F., Hernández-Cruz, B., López-Solano, J., Rodríguez-Franco, J. J., Vilaplana, J. M., Gröbner, J., Rimmer, J., Bais, A. F., Savastiouk, V., Moreta, J. R., Boulkelia, L., Jepsen, N., Wilson, K. M., Shirovov, V. and Karppinen, T.: EUBREWNET RBCC-E Huelva 2015 Ozone Brewer Intercomparison, *Atmospheric Chemistry and Physics*, 18(13), 9441–9455, doi:<https://doi.org/10.5194/acp-18-9441-2018>, 2018.
- Stübi, R., Schill, H., Klausen, J., Vuilleumier, L. and Ruffieux, D.: Reproducibility of total ozone column monitoring by the Arosa Brewer spectrophotometer triad, *Journal of Geophysical Research: Atmospheres*, 122(8), 4735–4745, doi:10.1002/2016JD025735, 2017.

17.8 Staff



Figure 17.15. Members of the RBCC-E team. Left to right: A. Redondas, A. Berjón, J. López-Solano, B. Hernández Cruz, V. Carreño, M. Rodríguez Valido, D. Santana, S. León Luis.

Alberto Redondas Marrero (AEMET; PI in charge of RBCC-E)

Virgilio Carreño (AEMET; Meteorological Observer-GAW Technician)

Dr Sergio Fabián León Luis (AEMET; Research Scientist)

Dr Javier López Solano (TRAGSATEC; Research Scientist)

Dr Alberto Berjón (TRAGSATEC; Research Scientist)

Daniel Santana (Sieltec/LuftBlick; Research Scientist)

Bentorey Hernandez Cruz (ULL; Research Scientist) left IARC in July 2018

Dr Francisco Parra Rojas (UIAPR; Research Professor)

Dr Manuel Rodriguez Valido (ULL, Research Scientist)

18 Sand and Dust Storm Centres

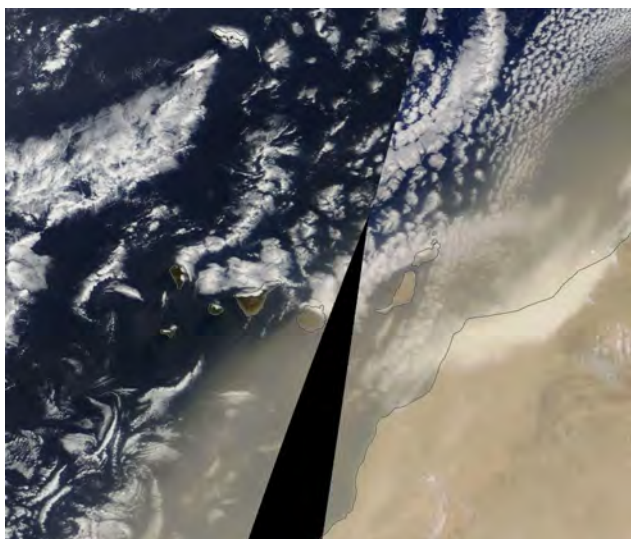

Figure 18.1. The Moderate Resolution Imaging Spectroradiometer (MODIS) on NASA's Terra satellite acquired this natural-color image of dust affecting the coast of Western Sahara and Morocco, and impacting half of the Canary Islands at mid-levels, on 18 July 2018. In lower levels the stratocumulus associated with trade winds are observed.

The IARC is actively involved in the strategic planning of activities, scientific advice on aerosols and dust observation, as well as in initiatives on capacity building and training of two Centers dedicated to Sand and Dust Storm activities: 1) the WMO Sand and Dust Storm Warning Advisory and Assessment System (SDS-WAS) Regional Center for Northern Africa, Middle East and Europe, and 2) the Barcelona Dust Forecast Centre (BDFC).

18.1 WMO Sand and Dust Storm Warning Advisory and Assessment System (SDS-WAS) Regional Center

The Sand and Dust Storm Warning Advisory and Assessment System (SDS-WAS) is a programme of the World Meteorological Organization with the mission to enhance the ability of countries to deliver timely and qualitative information related to sand and dust storm forecasts, observations to end users, and improve the knowledge of this phenomena.

The Regional Centre for Northern Africa, Middle East and Europe (NA-ME-E) was established in 2007 to coordinate SDS-WAS activities within this region. The Centre, as a consortium of the Spanish State Meteorological Agency (AEMET) and the Barcelona Supercomputing Centre – National Supercomputing Centre (BSC-CNS), soon evolved into a structure that hosted international and interdisciplinary research cooperation between numerous organizations in the region and beyond, including national meteorological services, environmental agencies, research groups and international organizations.

The Center's web portal (Fig. 18.2) became a place where visitors could find the latest dust-related observations and the most up-to-date experimental dust forecasts. The activities carried out by the SDS-WAS Regional Centre have been broadly disseminated in international workshops and conferences (Basart et al., 2018a; Cuevas et al., 2017b, 2017c). A detailed description of the main activities of the SDS-WAS regional Centre can be found in Terradellas et al. (2016).

A global observational network is crucial to any forecast and early warning system for real-time monitoring, validation and evaluation of forecast products, as well as for data assimilation. The main data sources are in-situ aerosol measurements performed in air quality monitoring stations, indirect observations (visibility and present weather) from meteorological stations, sun photometric measurements (e.g. AERONET network), lidar and ceilometers and satellite products.

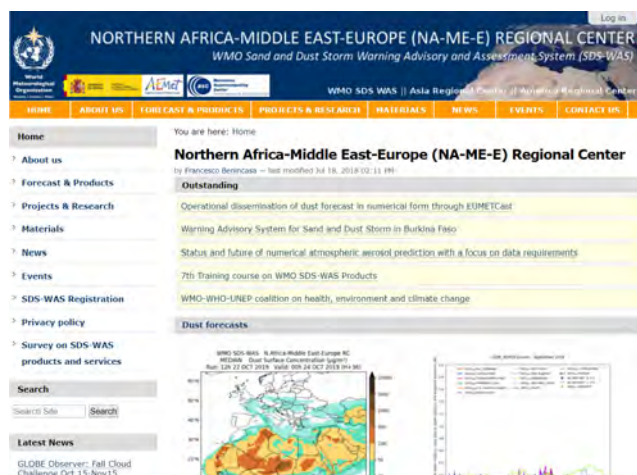

Figure 18.2. SDS-WAS Regional Center Web portal.

The exchange of forecast products is a core part of the WMO SDS-WAS programme and the basis for the joint visualization and evaluation initiative. The web portal offers side-by-side dust forecasts (dust surface concentration and dust optical depth at 550 nm) generated by 12 modelling systems as well as the multi-model median. The models are BSC-DREAM8b_v2, CAMS-ECMWF, DREAM8-NMME-MACC, NMME/BSC-Dust, NASA GEOS-5, NCEP-NGAC, EMA RegCM4, UK Met Office, DREAM ABOL, NOAA-WRF-CHEM, SILAM and LOTOS-EUROS.

An important stage of any forecasting system is the evaluation of the products. The main goal of this process is to assess whether the modelling systems successfully simulate the evolution of dust-related parameters. In addition, the evaluation improves the understanding of the models capabilities, limitations, and appropriateness for the purpose for which they were designed. The evaluation is performed by comparing the models forecasts with

observational data. The individual models and multi-model median forecasts of the dust optical depth (DOD) at 550 nm are compared with AERONET observations of aerosol optical depth (AOD) for 40 selected dust-prone stations. In addition to this near real time evaluation, a system to assess quantitatively the performance of the different models has been implemented. It yields evaluation scores computed from the comparison of the simulated DOD with the AERONET retrievals of AOD.

The SDS-WAS Regional Centre works toward strengthening the capacity of countries to use the observational and forecast products distributed in the framework of the WMO SDS-WAS programme in the partnership with National Meteorological and Hydrological Services (NMHSS) in the region and other relevant organizations.

18.1.1 Relevant activities and milestones in 2017-2018

The World Meteorological Organization launched in early 2017 an informative video about sand and dust storms and their impacts on climate, human health and the environment among other sectors. WMO highlights the importance of evaluating these impacts and developing products to guide preparedness, adaptation and mitigation policies. Barcelona Dust Forecast Center, as partner of WMO, plays a key role in this field, as the video shows. Kofi Annan, former Secretary-General of the United Nations, appears in this documentary and stresses the importance of international authorities and national and local organizations working together.

Further information can be found [here](#).

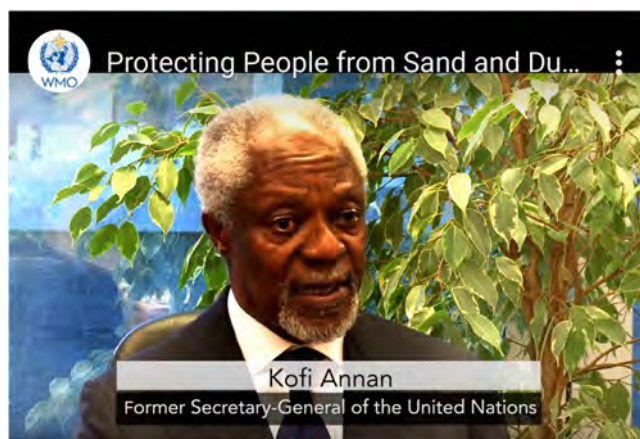
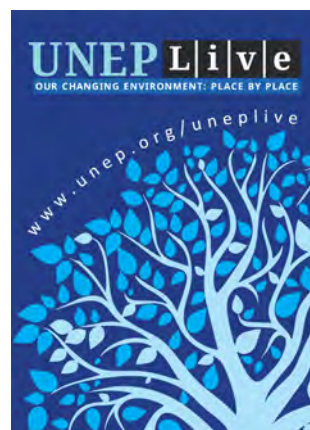

Figure 18.3. Former Secretary-General of the United Nations, Mr Kofi Annan during his speech in the documentary about SDS WAS broadcasted by WMO.

There are versions of the video in Spanish and French.

Dust forecasts produced by the WMO SDS-WAS RC NAMEE and the Barcelona Dust Forecast Center continue being disseminated via UNEPLive, a platform managed by the United Nations Environment Program.



In 2016, EUMETSAT relocated Meteosat-8, the first unit of MSG satellites, to 41.5°E, for the continuation of the Indian Ocean data coverage. It allows generation of the RGB-Dust product for West Asia, a region where the coverage was deficient through the MSG satellites centered on 0°. Since early SDS-WAS provides access to the EUMETSAT RGB-Dust product for the Middle Eastern region. The product is generated from METEOSAT-8 imagery.

WMO released the first issue of “Airborne Dust Bulletin” on March 2017 (Fig. 18.4). This first bulletin reports on the atmospheric burden of mineral dust through 2016, its geographical distribution and its inter-annual variation. A key challenge is the limited availability of suitable dust observations. The publication also reports on two outstanding dust cases occurred during the year, in East Asia and the Caribbean. Finally, it presents three short articles on high-latitude dust, on the EUMETSAT RGB-Dust product and on an EU financed international network to encourage the use of monitoring and forecasting dust products. In April, a short version (without news & events) was published in other official WMO languages (e.g., Spanish, French, Arabic, and Chinese) as well as in paper format.



Figure 18.4. WMO Airborne Dust Bulletin, No. 1, 2017.

On 29th September 2017, the Barcelona Supercomputing Center hosted the Kick-off meeting of the Dust Storms Assessment for the development of user-oriented Climate Services in Northern Africa, Middle East and Europe (DustClim) project funded by the EU European Research Area for Climate Services (ERA4CS) project. Five European institutions (Barcelona Supercomputing Center and AEMET, Spain; National Center for Scientific Research, France; Finnish Meteorological Institute, Finland; and National Research Council, Italy) are part of this project. Dr Sara Basart is the lead PI.



**European Research Area
for Climate Services**

The International Network to Encourage the Use of Monitoring and Forecasting Dust Products (**InDust**) is a European COST Action (CA16202). InDust started in November 2017 and is funded for a 4-year period. Its overall objective is to establish a network involving research institutions, service providers and potential end users of information on airborne dust. Because, airborne dust transport has multi- and trans-disciplinary effects at local, regional and global scales; InDust involves a multidisciplinary group of international experts on aerosol measurements, regional aerosol modelling, stakeholders and social scientists. InDust also searches to coordinate and harmonise the process of transferring dust observation and prediction data to users as well as to assist the diverse socio-economic sectors affected by the presence of high concentrations of airborne mineral dust.



These objectives are aligned with the mission of the WMO SDS-WAS programme. InDust is expected to strongly cooperate with the WMO SDS-WAS and to lead to improvements in the products delivered by the Barcelona Dust Forecast Center, which is the Centre designated by the WMO to generate and distribute operational dust forecasts to the National Meteorological and Hydrological Services of Northern Africa, Middle East and Europe.

The European Data Infrastructure (EUDAT) was launched to target a pan-European solution to the challenge of data proliferation in Europe's scientific and research communities. EUDAT's mission is to design, develop, implement and offer Common Data Services to all interested researchers and research communities. These common data services obviously must be relevant to several communities, be available at European level and be

characterized by a high degree of openness. SDS-WAS is currently working with EUDAT to implement a combination of federated storage with a web interface that makes a huge amount of dust datasets available to the community.



In 2015, AERONET evolved to the use of a new set of processing algorithms (AERONET version 3). The primary trigger for release of version 3 lies with cloud screening of the direct sun observations. After checking that dust optical depth derived from model simulations present better spatio-temporal correlation with AERONET V3 retrievals than with those of the previous version (Basart, 2017d), the SDS-WAS Regional Center began to use the new version of AERONET products for its forecast evaluation. For 2017, results obtained with the two versions are available.



The heads of the World Health Organization (WHO), UN Environment and WMO have launched a new global coalition on health, environment and climate change. One of its overall goals is to reduce the annual 12.6 million deaths caused by environmental risks, and especially air pollution. Many pollutants which damage health also harm the environment and contribute to climate change. These include black carbon from diesel engines, cooking stoves and waste incineration, and ground level ozone, which are harmful but are short lived in the atmosphere.



It is estimated that reductions in short-lived climate pollutant emissions from sources like traffic, cookstoves, agriculture and industry could help trim the rate of global warming by about 0.5°C by 2050.

The coalition begins with a joint focus on Air Quality outlining five areas of joint work. WMO's observing network, its Sand and Dust Storm Warning and Alert System and its Global Atmosphere Watch stations, which monitor the atmosphere, will be underpinning to the global drive to improve air quality mapping and monitoring. The SDS-WAS can play an important role in knowing when and where dust storms may occur, to allow health partners to plan more effectively and benefit from WMO global atmospheric monitoring and forecasting capacity on acute episodes of hazardous air quality – such as dust storms

The visibility product has been upgraded. In-situ measurements of particulate matter concentration are systematic and with high spatial density in Europe, but very sparse, discontinuous and rarely near-real-time available close to the main dust sources. Satellite products present global coverage. However, they usually integrate the aerosol contents over the vertical column and do not provide information about the dust contents close to the ground. Since weather records have an excellent spatial and temporal coverage, visibility data included in meteorological observations can be used as an alternative way to monitor dust events.

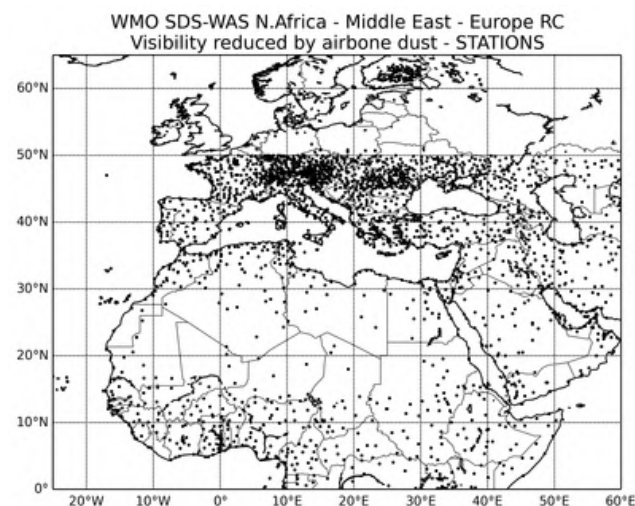

Figure 18.5. Map of locations of stations with visibility measurements utilised by WMO SDS-WAS NA-ME-E Regional Centre to assess visibility reduced by airborne dust.

Visibility is mainly affected by the presence of aerosol and water in the atmosphere. Therefore, the use of visibility data has to be complemented with information on present weather to discard those cases where visibility is reduced by the presence of hydrometeors (fog, rain, etc.). The SDS-WAS website publishes maps showing cases of visibility reduction by sand or dust to less than 5 km reported in METAR or SYNOP bulletins. The upgraded product is based on reports from more than 2,500 stations, which are

checked every 6 hours. Brownish circles indicate stations where 'sand' or 'dust' has been explicitly reported. Triangles indicate stations where the present weather has been reported as 'haze', meaning that the visibility is reduced by particles of unspecified origin.

A warning advisory system for sand and dust storm has been launched in the 13 administrative regions into which the territory of Burkina Faso is divided. Its core is a universally understood product based on colour-coded maps that indicate the risk of high dust concentrations during the next 48 hours. This system has been designed and is operated by the AEMET and BSC in collaboration with the Burkina Faso National Meteorological Agency. It is released by the WMO SDS WAS.

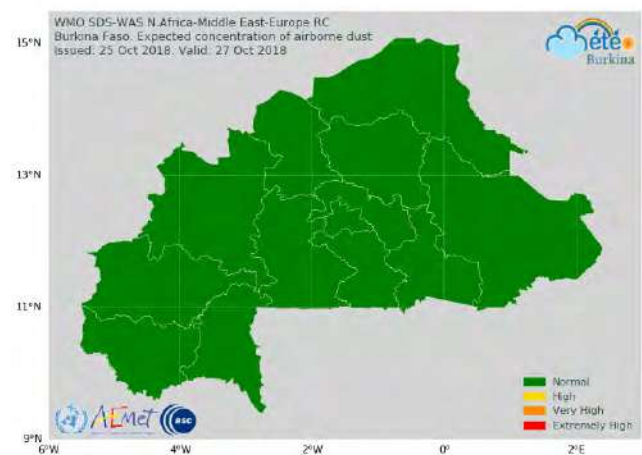

Figure 18.6. Example plot of SDS-WAS Burkina Faso forecasted airborne dust concentration for 27 October 2018.

The warning levels are computed based on the consensus of numerical predictions released by different meteorological services and research centers around the world. Burkina Faso is a landlocked African country lying in the transition zone between the Sahara to the north and the humid equatorial region to the south. It has a primarily tropical climate with a rainy season from May/June through September, a little shorter in the northern part of the country, and a dry season, when a hot dry wind called Harmattan blows from the Sahara.

During the dry season, frequent dust storms are one of the main meteorological hazards affecting the population. Airborne dust presents serious risks for human health. Some infectious diseases have been associated with airborne dust. Outbreaks of meningococcal meningitis, a bacterial infection of the thin tissue layer that surrounds the brain and spinal cord, occur worldwide, yet the highest incidence is found in the “meningitis belt”, a part of sub-Saharan Africa extending from Senegal to Ethiopia and including the entire territory of Burkina Faso. This system is described in Terradellas et al. (2018).

In 2018, a two-year pilot project was initiated to implement a surface dust alert system based on the outputs of a model assembly of the SDS-WAS Regional Center, improving it with Machine Learning techniques using the PM₁₀ observations of the Canary Islands Government air quality network and other auxiliary information. A preliminary analysis consisted of evaluating the predictions of dust surface concentration of each of the models participating in the SDS-WAS (García-Castrillo and Terradellas 2017).



Figure 18.7. Locations utilised for the evaluation of dust forecasts in the Canary Islands.

18.1.2 SDS-WAS Regional Center Scientific contributions

IARC and AEMET contribute to the scientific activities of the SDS-WAS Northern Africa, Middle East and Europe Regional Centre through various multidisciplinary studies.

IARC led a study entitled “The pulsating nature of large-scale Saharan dust transport as a result of interplays between mid-latitude Rossby waves and the North African Dipole Intensity” (Cuevas et al., 2017).

The main objective of this study was to explain the atmospheric processes behind the intra-seasonal variations of dust outflows towards the Mediterranean and the subtropical North Atlantic Ocean. Daily and monthly data of MODIS Aerosol Optical Depth MODIS aerosols, NCEP/NCAR reanalysis, ECMWF reanalysis, and MACC reanalysis (today CAMS) were used.

The North African Dipole Intensity (NAFDI) concept introduced by Rodríguez et al. (2015) was used to achieve this goal. It is defined as the difference of the 700 hPa geopotential height anomaly between the subtropics and the tropics over Northern Africa. Essentially, NAFDI represents the large-scale anomaly of the geostrophic wind at 700 hPa (about 3,000 m altitude) over Northern Africa. Under positive NAFDI index, there are greater dust outflows towards the subtropical North Atlantic (Fig. 18.8), whereas under negative NAFDI a positive dust anomaly is observed over the central and western Mediterranean. The first aim was to demonstrate that there is a summertime intra-seasonal variation of NAFDI (June-September), and that it modulates Saharan dust outflows not only to the Atlantic but also to the Mediterranean basin.

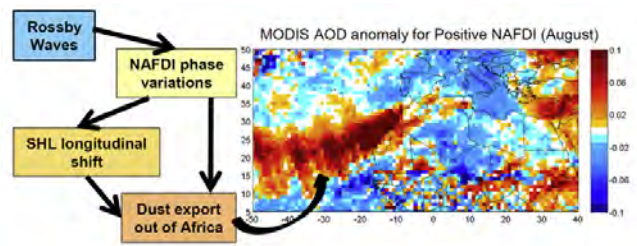

Figure 18.8. Graphical abstract. Reprinted from Cuevas et al. (2017).

The second challenge is to identify the physical mechanisms behind the connection between NAFDI and the Saharan Heat Low (SHL), which is well known to modulate numerous meso-scale meteorological processes that cause Saharan dust mobilization. The location and intensity of dust sources and dust outflows over Northern Africa depend to a large extent on the SHL position. The SHL can be found shifted farther east or west, and therefore conditioning the location and intensity of dust sources but, until now, the processes controlling these longitudinal shifts were unknown. On the other hand, the anomalies of different meteorological fields, such as temperature and wind at 925 hPa, as well as the geopotential thickness 700-925 hPa for positive (negative) NAFDI coincided with those found by other authors associated to the West (East) phase of SHL.

However, the most important question still was unanswered: What atmospheric mechanism explains the variations of NAFDI and SHL showing a variable period between 10 and 30 days? Based on the very interesting work of Chauvin et al. (2010), and bearing in mind the general principle in physics by which larger spatial scale processes modulate smaller processes, it is shown that mid-latitude Rossby waves penetrating into the lower troposphere over Northern Africa are the answer.



Figure 18.9. The ZEN-R41 radiometer located at SCO (in the foreground).

A recent study presents a new zenith-looking narrow-band radiometer-based system (ZEN), conceived for dust AOD monitoring (Fig. 18.9). The ZEN consists of a ZEN-R41 radiometer, which measures downwelling zenith sky radiance (ZSR) at four channels (870, 675, 500 y 440 nm) and a methodology for AOD retrieval (ZEN-LUT). The ZEN-R41 radiometer, designed to be stand-alone and

without moving parts, is a low-cost, robust and automated instrument with lower maintenance than ordinary sun-photometers. Thus, it is suitable to be deployed in remote and unpopulated desert areas.

The ZEN-LUT method, based on methodologies applied to satellite sensors, uses a radiative transfer code to simulate the ZSRs and their associated AODs. This method has been developed using information from Cimel-AERONET sun-photometers. The results of the preliminary study, conducted at IZO and SCO and Tamanrasset (Algeria) suggests that the ZEN-LUT method is appropriate to infer dust AOD from ZSR ZEN-R41 measurements. The comparison between ZEN-LUT and AERONET retrievals yields correlations (R^2) ranging from 0.99 for Santa Cruz and 0.97 for Tamanrasset.

The conclusion is that ZEN is a suitable system to fill the current observational gaps and to complement observations performed by current sun-photometer networks in order to improve mineral dust monitoring in remote locations. As a consequence, it can play a key role to provide information for data assimilation into numerical models, validation of satellite products and early warning systems within the SDS-WAS. The development of the instrument and retrieval methodology has been entirely conceived, designed, implemented and validated at IARC as one of the activities of the WMO-CIMO Testbed for Aerosols and Water Vapour Remote Sensing Instruments. This study has been published by Almansa et al. (2017) (see Section 20.5 for more details).

18.1.3 SDS-WAS and Copernicus CAMS-84 Service

The Copernicus programme, previously known as GMES (Global Monitoring for Environment and Security), consists of a complex set of systems, which collect data from multiple sources: earth observation satellites and in situ sensors such as ground stations, airborne and sea-borne sensors. It processes these data and provides users with reliable and up-to-date information through a set of services related to environmental and security issues.



The Copernicus Atmosphere Monitoring Service (CAMS) has been developed to address environmental concerns, providing data and processed information, aiming at

supporting policymakers, business and citizens with enhanced atmospheric environmental information.

CAMS-84 is a global and regional a posteriori validation activity, with focus on the Arctic and Mediterranean areas. The SDS-WAS Regional Centre, through BSC-CNS as the main partner and AEMET as a third-party, participates in CAMS-84 providing validations and evaluation of dust and aerosols products. Mineral dust validation activities were carried out as CAMS-84 services and published as Quarterly Reports. The SDS-WAS Regional Centre participated in the preparation of 13 reports during the period 2017-2018 (Antonakaki et al., 2017a, 2017b; Basart et al., 2017a, 2017b, 2018b, 2018c; Douros et al., 2017; Eskes et al., 2017a, 2017b, 2017c, 2018a, 2018b and Sudarchikova et al., 2018).

18.1.4 Workshops and Capacity building activities

During 2017-2018 the following capacity building activities were carried out.

“SDS-WAS: Dust observation and modelling” was a side event held during the GAW 2017 Symposium on 11 April 2017 at WMO headquarters (Geneva, Switzerland). The event focused firstly on the need of different communities for observational data: 1) Modeling community, for data assimilation and forecast evaluation; 2) National Meteorological and Hydrological Services, for dust monitoring and nowcasting; and 3) End-users of different sectors (air quality, health, aviation, solar energy).

Secondly, there was a review of the state-of-the-art of dust observation, describing current and potential capabilities of different platforms (in situ, ground-based remote sensing, satellite) as well as their geographical coverage and data availability. The following presentations were given: 1) Enric Terradellas (AEMET), Observational needs; 2) Emilio Cuevas (AEMET), Ground observation; 3) Taichu Tanaka (Japan Meteorological Agency), Satellite observation; and 4) Valentin Foltescu (United Nations Environment Programme), UNEP view.

SDS-WAS contributed to the International Conference on Combating Sand and Dust Storms held in Tehran on 3-5 July 2017. The International Conference was hosted by the Department of Environment and the Ministry of Foreign Affairs of the Islamic Republic of Iran, with the cooperation of the Department of relevant UN entities. In particular, SDS-WAS contributed to Session 4 (Source Recognition, Monitoring, Observation, Forecasting and Early Warning Systems) moderated by Enric Terradellas (AEMET), with talks by Bassem Katlan, land degradation specialist at the Arab Centre for the Study of Arid Zones and Dry Lands (ACSAD), and Ana Vukovic, researcher from the University of Belgrade, Serbia.



Among other priorities, the conference was due to consider the establishment of a global platform for policy dialogue and coordination on sand and dust storms and to contribute to knowledge-sharing on policies and best practices and capacity building. This would build upon and expand the structure of the WMO SDS-WAS.

The “International Workshop on Middle East (Regional) Dust Sources and their Impacts” was held on 23-25 October 2017 in Istanbul (Turkey) to share and evaluate scientific research on the sources, transport, monitoring and impacts of dust. The main goal of this workshop was to exchange information and share experience between interested scientists and related organizations to better evaluate dust sources and impacts in the Middle East. The workshop was focused on: 1) Dust sources and monitoring the changes on these sources over Middle East Region; 2) Dust-Climate interaction in the Middle East 3) Dust forecast and modelling; and 4) Monitoring and impacts of dust transport affecting Middle East. The IARC contributed with a lecture on dust ground-based observations.



The 6th Training Course on WMO SDS-WAS Products (Satellite and Ground Observation and Modelling of Atmospheric Dust) was held in Istanbul, Turkey, 25-27 October 2017. This training course was focused on West Asia, the second largest source of global dust after the Sahara desert. In West Asia, unlike North Africa, where large population centres are concentrated along the coasts of the Mediterranean and the Atlantic Ocean, relatively far away from dust sources, much of the population in West Asia lives inside, or in the vicinity of, dust sources. The

impact on air quality, on ecosystems and on many economic and social activities is therefore of utmost importance.

AEMET has published a video about the significant impacts of airborne dust on air quality and health, air transportation, terrestrial and marine ecosystems, weather and climate, and generation of solar energy. The video was recorded on the occasion of a one-day Conference on this topic that was held in Madrid, on 22 Nov 2017, targeted to potential users of dust-related information (see Section 22.5 for more details). The video can be seen [here](#).

Cooperation between Spain and Iran in the framework of SDS-WAS. Dr Saviz Sehat Kashani, Academic member of Atmospheric Science and Meteorological Research Center (ASMERC) of the Islamic Republic of Iran Meteorological Organization (IRIMO), participated in the training course on “Atmospheric Aerosols and Mineral Dust” which was held at the Izaña Observatory from 20th June to 6th July 2017 (see Section 21.1 for more details).

The training course was organized by the SDS-WAS NA-ME-E Regional Centre. The training was performed at the IARC facilities. A half-day special session was dedicated to discuss with several IARC researchers potential collaboration between IRIMO and AEMET in the framework of SDS-WAS. On the return trip to Tehran, Dr Saviz Sehat made a one-day stop in Barcelona, where she had the opportunity to meet researchers from the Barcelona Supercomputing Center: Dr Sara Basart and Dr Enza Di Tomaso, with whom she discussed several aspects of SDS-WAS and assessed the opportunity to join the SDS-WAS activities in model validation and mineral dust characterization for Iran, a key region, from which there is very little information.



Figure 18.10. Dr Saviz Sehat (bottom-right) with the participants of the ACE20 workshop at the door of the Aerosol Research Laboratory "Joseph M. Prospero", and with Prof. Prospero (standing, 3rd from the left), 5 July 2017.

AEMET organized the Training Workshop on Sand and Dust Storms in West Africa in La Laguna, Spain, on 21 May 2018 in collaboration with WMO, BSC, EUMETSAT and InDust (COST Action CA16202). The event was attended by 10 meteorologists from West African countries plus two

researchers from UAE and South Korea. The objectives of the workshop were to:

- 1) Enhance the understanding of the physical processes involved in the dust cycle and the impacts of airborne dust on air quality, health, aviation and diverse socio-economic sectors.
- 2) Enhance the technical capacities of operational meteorologists from West Africa on the analysis and prediction of sand and dust storms, including the use of ground and satellite observations, as well as available dust predictions

The event was presented by Mr Bernard Edward Gomez, WMO representative for North, Central and West Africa, Ms Carmen Rus, AEMET DPEDC Director and Mr Antonio Conesa, AEMET officer in charge of the AFRIMET cooperation project. Materials from the training event have been posted [here](#).



Figure 18.11. Participants of the training workshop on “Sand and Dust Storms in West Africa”, held in La Laguna, Spain, 21 May 2018.

The SDS-WAS team gave two lectures on airborne dust at the ERA4CS Summer School (Pisa, Italy, 10-14 Sep 2018). The summer school focused on multidisciplinary, up to date view of the latest observations, models, projections, adaptation strategies, and services to mitigate climate change impacts with research and education. ERA-4CS-Summer School invited young researchers from all fields of climate research. The courses covered a broad spectrum of climate and climate impact research issues and fostered on cross-disciplinary links. Each topic included keynote plenary lectures and a round table with in-depth discussion in smaller groups.



18.2 The Barcelona Dust Forecast Centre

In May 2013, in view of the demand of many national meteorological services and the good results obtained by the SDS-WAS related to operationalization, the 65th Session of the WMO Executive Council designated the consortium formed by AEMET and the BSC-CNS to create in Barcelona the first Regional Specialized Meteorological Centre with activity specialization on Atmospheric Sand and Dust Forecast (RSMC-ASDF). The Centre operationally generates and distributes predictions for Northern Africa (north of equator), Middle East and Europe.

The Barcelona Dust Forecast Centre prepares regional forecast fields using the NMMB/BSC-Dust model continuously throughout the year on a daily basis (Terradellas et al., 2015). The model consists of a numerical weather prediction model incorporating on-line parameterizations of all the major phases of the atmospheric dust cycle. It is run at a horizontal resolution of 0.1 degrees longitude per 0.1 degrees latitude for a domain covering Northern Africa, Middle East and Europe (25°W-65°E, 0°-65°N). This domain covers the main dust source areas in Northern Africa and Middle East, as well as the main transport routes and deposition zones from the equator to the Scandinavian Peninsula.

Following its efforts to make the predictions reach all potential users and, in particular, the national meteorological and hydrological services, the BDFC started to broadcast dust forecast through the EUMETCast service in November 2015.

18.3 Change of technical director of the two WMO regional dust Centres

In 2018 and part of 2017 a careful and prolonged work of transfer of know-how was carried out to ensure the smooth change of technical director of the two centres. Enric Tarradellas (AEMET) retired in April 2019, and Ernest Werner (AEMET) took over the position of technical director. The magnificent work carried out during all these years by Enric to establish first, and then consolidate the two regional dust centres of the World Meteorological Organization, deserves all our sincere praise and thanks. It has been a pleasure to collaborate with him and count on his enthusiasm and determination. Our best wishes for Enric in his new life, we will miss him greatly. The technical direction of the SDS-WAS Regional center NA-ME-E and the Barcelona Dust Forecast Centre will be exercised with no less enthusiasm and dedication by Ernest from 2019, to which we will give all our support from the IARC.

18.4 References

- Almansa, A. F., Cuevas, E., Torres, B., Barreto, Á., García, R. D., Cachorro, V. E., de Frutos, Á. M., López, C., and Ramos, R.: A new zenith-looking narrow-band radiometer-based system (ZEN) for dust aerosol optical depth monitoring, *Atmos. Meas. Tech.*, 10, 565-579, doi:10.5194/amt-10-565-2017, 2017.
- Antonakaki, T.; Basart, S.; Benedictow, A.; Blechschmidt, A.-M.; Chabrillat, S.; Clark, H.; Cuevas, E.; Eskes, H.J.; Hansen, Kaj Mantzius; Im, Ulas; Kapsomenakis, J.; Langerock, B.; Petersen, K.; Richter, A.; Schulz, M.; Sudarchikova, N.; Thouret, V.; Wagner, A.; Zerefos, C., Upgrade verification note for the CAMS near-real time global atmospheric composition service, Copernicus Atmosphere Monitoring Service (CAMS) Report, 2394630730, 2017a.
- Antonakaki, T.; Basart, S.; Benedictow, A.; Blechschmidt, A.-M.; Chabrillat, S.; Christophe, Y.; Clark, H.; Cuevas, E.; Eskes, H.J.; Hansen, Kaj Mantzius; Im, Ulas; Kapsomenakis, J.; Langerock, B.; Ramonet, M.; Richter, A.; Schulz, M.; Sudarchikova, N.; Wagner, A.; Warneke, T.; Zerefos, C., Evaluation of the CAMS 2010 reanalysis test run experiment gls8, Copernicus Atmosphere Monitoring Service (CAMS) Report, 2394630729, 2017b.
- Basart, S.; Blechschmidt, A.-M.; Chabrillat, S.; Clark, H.; Cuevas, E.; Eskes, H.J.; Flentje, H.; Hansen, Kaj Mantzius; Kapsomenakis, J.; Katragkou, E.; Langerock, B.; Petersen, K.; Ramonet, M.; Richter, A.; Schulz, M.; Wagner, A.; Zerefos, C., Data Mining: potential new observations for the CAMS validation activity, Copernicus Atmosphere Monitoring Service (CAMS) Report, 2394630726, 2017a.
- Basart, S., E. Cuevas, M.T. Pey, and O. Jorba, CAMS-84 NRT report MAM 2017 and Dust Reanalysis 2003, Jornada Técnica sobre los servicios de Atmósfera y Clima de Copernicus, Agencia Estatal de Meteorología (AEMET), November 27th, 2017b.
- Basart, S., E. Cuevas, M.T. Pey, and O. Jorba, CAMS-84 NRT report MAM 2017 and Dust Reanalysis 2003, Jornada Técnica sobre los servicios de Atmósfera y Clima de Copernicus, Agencia Estatal de Meteorología (AEMET), November 27th, 2017c.
- Basart, S.: Forecast Evaluation: AERONET vs. Multimodel Forecast for 2016; Technical Report SDS-WAS-2017-001, 7 pp, available at <https://sds-was.aemet.es/materials/technical-reports/SDS-WAS-NAMEE-2017-001.pdf>, April 3th, 2017d.
- Basart, S., García-Castrillo, G., Cuevas, E., Goloub, P., Cazorla, A., Alastuey, A., Mortier, A., Benedetti, A. and Terradellas, E. Towards continuous evaluation of dust profiles in the WMO SDS-WAS. 9th International Workshop on Sand/Dust storms and Associated Dustfall, La Laguna, Tenerife, Spain, 22-24 May 2018a.
- Basart, S.; Benedictow, A.; Bennouna, Y.; Blechschmidt, A.-M.; Chabrillat, S.; Clark, H.; Cuevas, E.; Flentje, H.; Hansen, Kaj Mantzius; Im, Ulas; Kapsomenakis, J.; Langerock, B.; Petersen, K.; Richter, A.; Sudarchikova, N.; Thouret, V.; Warneke, T.; Zerefos, C., Validation report of the CAMS near-real time global atmospheric composition service March - May 2018, Copernicus Atmosphere Monitoring Service (CAMS) Report, 2443544147, 2018b.
- Basart, S.; Benedictow, A.; Bennouna, Y.; Blechschmidt, A.-M.; Chabrillat, S.; Christophe, Y.; Clark, H.; Cuevas, E.; Eskes, H.; Hansen, Kaj Mantzius; Im, Ulas; Kapsomenakis, J.; Langerock, B.; Petersen, K.; Schulz, Wagner, A.; Zerefos, C., Addendum to: Upgrade verification note for the CAMS near-real time global atmospheric composition service Evaluation of the e-suite experiment gu42, Copernicus Atmosphere Monitoring Service (CAMS) Report, 2443544151, 2018c.
- Cuevas, E., A.J. Gómez-Peláez, S. Rodríguez, E. Terradellas, S. Basart, R.D. García, O.E. García, S. Alonso-Pérez: The pulsating nature of large-scale Saharan dust transport as a result of interplays between mid-latitude Rossby waves and the North African Dipole Intensity, *Atmospheric Environment*, 167, 586-602, ISSN 1352-2310, <https://doi.org/10.1016/j.atmosenv.2017.08.059>, 2017a.
- Cuevas, E., Ground Observation, SDS-WAS: Dust observation Side Event, GAW Symposium, WMO headquarters, Geneva, Switzerland, 10-13 April 2017b.
- Cuevas, E., E. Terradellas, and S. Nickovic, Sand and Dust Storm Advisory, 10th Session WWRP Scientific Steering Committee (WWRP SSC10), Geneva, WMO Headquarters, 25-26 October 2017c.
- Douros, J.; Basart, S.; Benedictow, A.; Blechschmidt, A.-M.; Chabrillat, S.; Christophe, Y.; Clark, H.; Cuevas, E.; Eskes, H.J.; Flentje, H.; Hansen, Kaj Mantzius; Kapsomenakis, J.; Langerock, B.; Petersen, K.; Ramonet, M.; Richter, A.; Schulz, M.; Wagner, A.; Warneke, T.; Zerefos, C., Observations characterization and validation methods document, Copernicus Atmosphere Monitoring Service (CAMS) Report, 2394630727, 2017.
- Eskes, H.; Clark, H.; Schulz, M.; Christophe, Y.; Ramonet, M.; Basart, S.; Benedictow, A.; Blechschmidt, A.-M.; Chabrillat, S.; Cuevas, E.; Flentje, H.; Hansen, Kaj Mantzius; Im, Ulas; Jossoud, O.; Kapsomenakis, J.; Langerock, B.; Petersen, K.; Richter, A.; Sudarchikova, N.; Thouret, V.; Wagner, A.; Warneke, T.; Zerefos, C., Validation report for the CAMS global reanalyses of aerosols and reactive trace gases, year 2003, Copernicus Atmosphere Monitoring Service (CAMS) Report, 2394630728, 2017a.
- Eskes, H.J., A. Wagner, M. Schulz, Y. Christophe, M. Ramonet, S. Basart, A. Benedictow, A.-M. Blechschmidt, S. Chabrillat, H. Clarck, E. Cuevas, H. Flentje, K.M. Hansen, U. IM, J. Kapsomenakis, B. Langerock, K. Petersen, A. Richter, N. Sudarchikova, V. Thouret, T. Warneke, C. Zerefos, Validation Report of the CAMS Near-Real Time Global Atmospheric Composition Service: December 2016-February

- 2017, Copernicus Atmosphere Monitoring Service (CAMS) Report, CAMS84_2015SC2_D84.1.1.7_2017DJF_v1.pdf, MAY 2017b.
- Eskes, H.J., A. Wagner, M. Schulz, Y. Christophe, M. Ramonet, S. Basart, A. Benedictow, A.-M. Blechschmidt, S. Chabbrillat, H. Clark, E. Cuevas, H. Flentje, K.M. Hansen, U. IM, J. Kapsomenakis, B. Langerock, A. Richter, N. Sudarchikova, V. Thouret, T. Warneke, C. Zerefos, Validation Report of the CAMS Near-Real-Time Global Atmospheric Composition Service: September-November 2016, Copernicus Atmosphere Monitoring Service (CAMS) Report, CAMS84_2015SC2_D84.1.1.6_2016SON_v1.pdf, February 2017c.
- Eskes, H.; Antonakaki, T.; Basart, S.; Benedictow, A.; Blechschmidt, A.-M.; Chabbrillat, S.; Christophe, Y.; Clark, H.; Cuevas, E.; Hansen, Kaj Mantzius; Im, Ulas; Kapsomenakis, J.; Langerock, B.; Petersen, K.; Richter, A.; Schulz, M.; Sudarchikova, N.; Thouret, V.; Wagner, A.; Zerefos, C.; Upgrade verification note for the CAMS near real time global atmospheric composition service Evaluation of the e-suite (experiment gp1p) for the period November 2016 - May 2017, Copernicus Atmosphere Monitoring Service (CAMS) Report, 2443544157, 2018a.
- Eskes, H.; Wagner, A.; Schulz, M.; Christophe, Y.; Ramonet, M.; Basart, S.; Benedictow, A.; Bennouna, Y.; Blechschmidt, A.-M.; Chabbrillat, S.; Clark, H.; Cuevas, E.; Flentje, H.; Hansen, Kaj Mantzius; Im, Ulas; Kapsomenakis, J.; Langerock, B.; Petersen, K.; Richter, A.; Sudarchikova, N.; Thouret, V.; Warneke, T.; Zerefos, C., Validation report of the CAMS near-real time global atmospheric composition service December 2017 – February 2018, Copernicus Atmosphere Monitoring Service (CAMS) Report, 2443544144, 2018a.
- Eskes, H.; Wagner, A.; Schulz, M.; Christophe, Y.; Ramonet, M.; Basart, S.; Benedictow, A.; Bennouna, Y.; Blechschmidt, A.-M.; Chabbrillat, S.; Clark, H.; Cuevas, E.; Flentje, H.; Hansen, Kaj Mantzius; Im, Ulas; Kapsomenakis, J.; Langerock, B.; Petersen, K.; Richter, A.; Sudarchikova, N.; Thouret, V.; Warneke, T.; Zerefos, C., Validation report of the CAMS near-real-time global atmospheric composition service. Period September-November 2017, Copernicus Atmosphere Monitoring Service (CAMS) Report, 2443486608, 2018b.
- García-Castrillo, G. and E. Terradellas: Evaluation of the dust Forecasts in the Canary Islands, WMO SDS-WAS, Barcelona, 21 pp. SDS-WAS-2017-002, 2017.
- Sudarchikova, N.; Basart, S.; Katragkou, Eleni; Petersen, K.; Akritidis, S.; Kartsios, S.; Zanis, P.; Melas, D.; Chabbrillat, S.; Christophe, Y.; Ramonet, M.; Bennouna, Y.; Clark, H.; Wagner, A.; Schulz, M.; Blechschmidt, A.-M.; Cuevas, E.; Flentje, H.; Hansen, Kaj Mantzius; Kapsomenakis, J.; Langerock, B.; Warneke, T.; Eskes, H. Compendium of case studies for the period 2015-2018, Copernicus Atmosphere Monitoring Service (CAMS) Report, 2443544159, 2018.
- Terradellas, E., S. Basart, and E. Cuevas: 2013-2015 Activity Report of the SDS-WAS Regional Center for Northern Africa, Middle East and Europe, Joint publication of AEMET and WMO; NIPO: 281-16-007-3; WMO / GAW Report No. 230; WMO / WWRP No. 2016-2, 2016.
- Terradellas, E., Werner, E., Basart, S. and F. Benincasa 2018: Warning Advisory System for Sand and Dust Storm in Burkina Faso, WMO SDS-WAS, Barcelona, 9 pp. SDS-WAS-2018-001, 2018.

18.5 Staff

- Enric Terradellas (AEMET, former Technical Director of the SDS WAS Regional Centre NA-ME-E, and the BDFC)
 Ernest Werner (AEMET, current Technical Director of the SDS WAS Regional Centre NA-ME-E, and the BDFC)
 Dr Emilio Cuevas (AEMET; Scientific Advisor)
 Dr Sara Basart (BSC; Research Scientist)
 Francesco Benincasa (BSC-AEMET; Technical support)
 Kim Serradell (BSC; Technical support)
 Dr Sergio Rodríguez (AEMET; Research Scientist; now at CSIC).
 Dr Natalia Prats (AEMET; Research Scientist)

19 GAW Tamanrasset twinning programme

In 2006, the “GAW-Twinning” between IZO and Tamanrasset GAW stations was initiated with the Saharan Air Layer Air Mass characterization (SALAM) project. This was part of a cooperation programme between the l’Office Nationale de la Météorologie (ONM, Algeria) and AEMET. In September 2006, the AERONET Tamanrasset-AEMET Cimel station was installed (Fig. 20.1).



Figure 19.1. The AERONET Cimel at Tamanrasset on the terrace of the Regional Meteorological Centre.

This station now has a relatively long time series of AERONET data (Fig. 19.2), despite the enormous environmental and logistical difficulties to keep it in operation, in large part thanks to the effort and great collaboration of the human team in charge of the station GAW Tamanrasset-Assekrem.

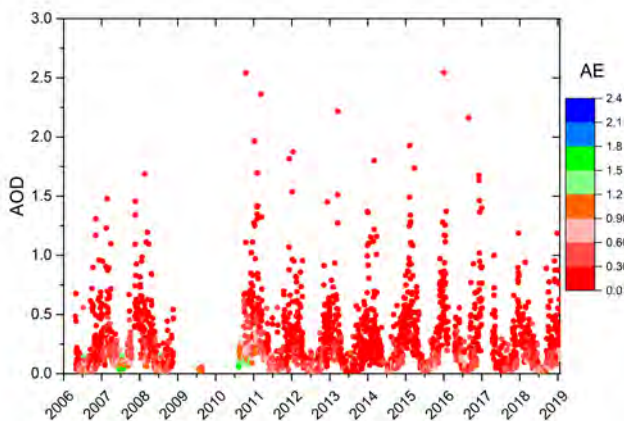

Figure 19.2. The Tamanrasset AERONET AOD data series (2006-2018).

The GAW station Tamanrasset is in the south of Algeria, in the heart of the Sahara, and provides unique and precious data in a region with a surface area greater than Europe, near important dust sources. Tamanrasset station is the only permanent AERONET observation site in the heart of the Sahara region (Fig. 19.3a). This station is strategic not only for the characterization of atmospheric composition over the Sahara desert in the frame of the GAW Programme, but also to evaluate atmospheric models and validate satellite data.

In fact, it is a key station to assess the performance of mineral dust prediction models in a challenging region where there are numerous nearby dust sources. The scientific community regularly uses data from Tamanrasset in various studies (e.g. Xu et al., 2018).

Tamanrasset is a singular station of special attention for the Sand and Dust Storm Warning Advisory and Assessment System Regional Center (e.g. Terradellas et al., 2016) (see Section 18 for more details). This AERONET photometer is calibrated by the IARC on an approximately annual basis. Details of this programme are provided in Guirado et al. (2014).

An automatic comparison of 12 model forecasts of dust optical depth (DOD) at 550 nm versus AERONET AOD data for the month of July 2018 at Tamanrasset is shown in Fig. 19.3b. This comparison is available at the SDS-WAS website.

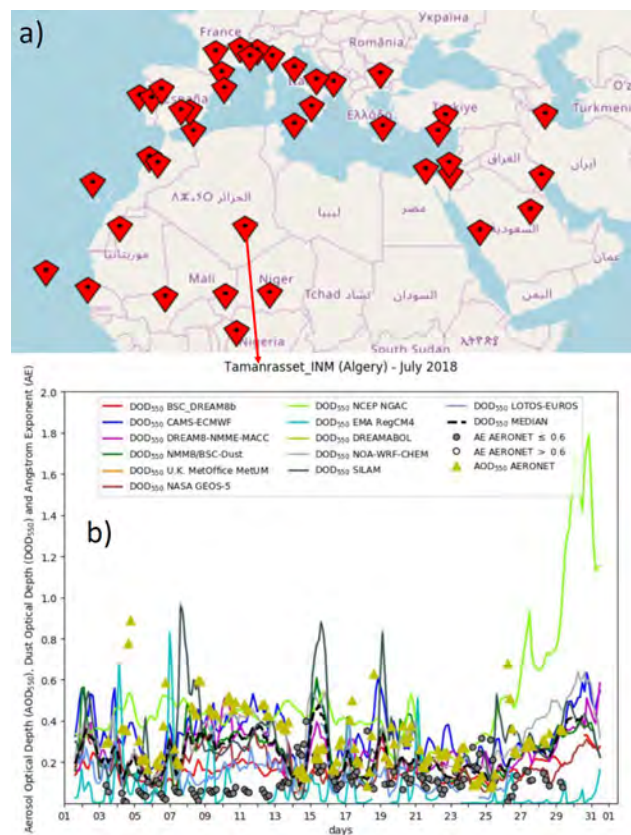

Figure 19.3. a) Map of the AERONET stations in Northern Africa used by the Sand and Dust Storm Warning Advisory and Assessment System Regional Centre and b) AERONET dust AOD comparison with 12 dust models, dust optical depth (DOD) and median of the models at Tamanrasset in July 2018.

Tamanrasset is also a key station for evaluating global operational forecast services, such as CAMS-Copernicus, in conditions of almost pure dust. An automatic comparison of CAMS-Copernicus outputs for several aerosol types with the Tamanrasset AERONET level 1.5 AOD data for the month of April 2018 is shown in Fig. 19.4 and can be found [here](#). The agreement for dust and total aerosols is fairly good.

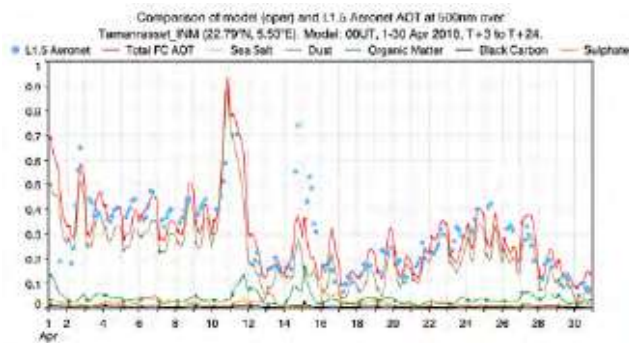

Figure 19.4. Comparison of COPERNICUS CAMS operational aerosols and AERONET level 1.5 AOD at Tamanrasset site during April 2018.

The twinning was completed with the installation at Tamanrasset of a double Brewer Spectrophotometer #201 (MARK-III) in October 2011 (Fig. 19.5), thanks to the project entitled “Global Atmosphere Watch in the Maghreb-Sahara Region” (GAW-Sahara) financed by the Spanish Agency for International Development Cooperation (AECID).



Figure 19.5. Brewer#201 at Tamanrasset on the terrace of the Regional Meteorological Centre.

An operational Dobson (#11; WMO station code 002) spectrophotometer has been operated at Tamanrasset since April 1994. This station is now one of the few sites in the world where permanent and long-term intercomparison between the Dobson, the Brewer and the present and future satellite-based sensors could be performed on a routine basis. This initiative has been strongly recommended by the WMO Ozone Scientific Advisory Group and represents a unique contribution to the total ozone global network Quality Assurance. In addition, the Brewer instrument provides spectral ultraviolet radiation data.

Tamanrasset, with the Brewer Spectrophotometer #201, plays an important role in the context of other global observation networks, e.g. in the EUBREWNET network (Fig. 19.6) (see Section 6.3.1 for more details) providing near-real time data of column ozone, spectral radiation and AOD in the UV range (see López-Solano et al., 2018). This equipment is periodically calibrated by the Regional Brewer Calibration Center for Europe hosted by the IARC taking

advantage of the biannual intercomparisons that are held at the INTA station at El Arenosillo-Huelva (Southern Spain).



Figure 19.6. Top panel, the Brewer spectrophotometer of Tamanrasset as part of the EUBREWNET network. Lower panel, example of total ozone data display on 24 July 2018.

A multifilter radiometer from the Norwegian Institute for Air Research (NILU) has been operating at the high-altitude Assekrem GAW station (2730 m a.s.l) 80 km north of Tamanrasset (Fig. 19.7) since October 2011. The high mountain Assekrem station is also a facility of the ONM managed by the Meteorological Centre of the Algerian South-Region.



Figure 19.7. The NILU-UV6 radiometer at Assekrem. In the background, mountains of the Hoggar massif.

The NILU multifilter radiometer at Assekrem station provides UV radiation, Photosynthetic Active Radiation (PAR) and total column ozone data at a high-altitude site in the middle of the Sahara.

Since March 2017, a Calitoo hand-held sun photometer has been operating at Tamanrasset. During this time, the performance of the Calitoo under the challenging conditions in a desert area have been tested with very good results (see Fig. 19.8). In the future, the objective is to take measurements with the Calitoo in the high-altitude Assekrem GAW station. As a result, total column aerosol properties could be retrieved at different altitudes in the heart of the Sahara desert (at Tamanrasset with the Cimel sun-photometer and at Assekrem with the Calitoo).

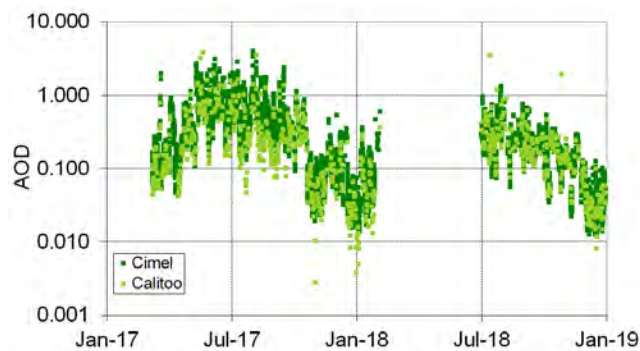

Figure 19.8. AERONET AOD computed at 500 nm from Cimel sun-photometer versus AOD computed at 540 nm from CALITOO hand-held sun-photometer at Tamanrasset. The gap in data is due to the replacement of the Calitoo for a newly calibrated one after one year of operation.

19.1 References

- Guirado, C., Cuevas, E., Cachorro, V. E., Toledano, C., Alonso-Pérez, S., Bustos, J. J., Basart, S., Romero, P. M., Camino, C., Mimouni, M., Zeudmi, L., Goloub, P., Baldasano, J. M., and de Frutos, A. M.: Aerosol characterization at the Saharan AERONET site Tamanrasset, *Atmos. Chem. Phys.*, 14, 11753-11773, doi:10.5194/acp-14-11753-2014, 2014.
- López-Solano, J., Redondas, A., Carlund, T., Rodríguez-Franco, J. J., Diémoz, H., León-Luis, S. F., Hernández-Cruz, B., Guirado-Fuentes, C., Kouremeti, N., Gröbner, J., Kazadzis, S., Carreño, V., Berjón, A., Santana-Díaz, D., Rodríguez-Valido, M., De Bock, V., Moreta, J. R., Rimmer, J., Smedley, A.R.D., Boulkelia, L., Jepsen, N., Eriksen, P., Bais, A. F., Shiroto, V., Vilaplana, J. M., Wilson, K. M., and Karppinen, T. Aerosol optical depth in the European Brewer Network, *Atmos. Chem. Phys.*, <https://doi.org/10.5194/acp-18-3885-2018>, 18, 3885-3902, 2018.
- Terradellas, E., S. Basart, and E. Cuevas: 2013-2015 Activity Report of the SDS-WAS Regional Center for Northern Africa, Middle East and Europe, Joint publication of AEMET and WMO; NIPO: 281-16-007-3; WMO / GAW Report No. 230; WMO / WWRP No. 2016-2, 2016.
- Xu, Y.: Evaluation of mineral dust aerosol optical depth and related components from the CHIMERE-DUST model using satellite remote sensing and ground-based observations, *Atmospheric Environment*, 191, 395-413, 2018.

19.2 Staff

Dr Emilio Cuevas (AEMET, PI of the Tamanrasset-Izaña twinning)

Alberto Redondas (AEMET, PI of the Ozone and UV Programme)

Ramón Ramos (AEMET, logistics and instrumentation)

Dr Carmen Guirado Fuentes (UVA/AEMET) left IARC in September 2019

Virgilio Carreño (AEMET; Meteorological Observer-GAW Technician)

Local contributors:

Mr Sidi Baika (Tamanrasset-Assekrem GAW station, Head)

Mr L. Zeudmi-Sahraoui and Mr M. Zoukani (Technical staff).

20 WMO CIMO Testbed for Aerosols and Water Vapour Remote Sensing Instruments

The mission of the Commission for Instruments and Methods of Observations (CIMO) is to promote and facilitate international standardisation and compatibility of instruments and methods of observations used by Members, in particular within the WMO Global Observing System, to improve quality of products and services delivered to/by Members and to meet their requirements (see [Report](#) from the President to Cg-XV (2007), [Report](#) from the President to Cg-XVI (2011) and [Report](#) from the President to Cg-XVII (2015).

CIMO-XV (2010) decided to establish CIMO Testbeds and Lead Centres to promote collaboration between CIMO and relevant NMHSs in testing, development and standardization of meteorological instruments and in assessing systems performance. It would utilize and build on both existing and state-of-the-art facilities and specific expertise available at NMHSs for the provision of guidance to all WMO Members.

CIMO XVI nominated Izaña Atmospheric Observatory as WMO-CIMO Testbed for Aerosols and Water Vapour Remote Sensing Instruments. The CIMO aim to promote the advancement of observing systems of WMO member countries through its WMO Integrated Global Observing System (WIGOS). It is also expected that Testbeds centres can play a decisive role in the effort of WMO to reduce the differences between countries, favouring the completion of training and capacity building through specific collaborations with stations and observatories in developing countries. The General Terms of Reference for the CIMO Testbeds for Ground based Remote-sensing and In-situ Observations (CIMO TB) can be found at the [Terms of Reference of CIMO Testbeds](#).

Since mid-October 2017, the Izaña Testbed facility enlarged the photometer calibration platform. The capability to simultaneously calibrate master/field instruments has been extended from 8 to 20 units. The new installation has required two new heavy, stable and labelled aluminum tables, five new stainless shelter cases, and rewiring works.

20.1 Main objectives and activities of the Izaña Testbed

The main ongoing activities of the Izaña Atmospheric Observatory Testbed are related to instrument validation, development of new methodologies and devices for aerosol observations.

20.2 Products obtained at the Izaña Atmospheric Observatory from EKO spectral direct irradiance measurements

The Izaña Observatory acquired an EKO MS-711 spectroradiometer in 2016, it began to measure continuously in March 2017. This spectroradiometer is designed to measure the global solar spectrum, although EKO Instruments designed a collimator tube that allows measurements to be made of Direct Normal Irradiance (DNI) (for more information see Section 10.2). From the measurements of DNI we have obtained AOD, water vapour and direct radiation between March 2017 and December 2018.

20.2.1 AOD

The spectral AOD was obtained from the DNI measured at ground level, using the Beer-Lambert-Bouguer law:

$$AOD = \frac{1}{m_a} [\ln DNI_o(\lambda) - \ln DNI(\lambda) - \tau_R m_R - \tau_{gas} m]$$

where $DNI_o(\lambda)$ is the top-of-atmosphere irradiance corrected for the Sun–Earth distance at wavelength λ and it was determined from the Langley method (Shaw et al., 1973), $DNI(\lambda)$ is the direct solar irradiance at wavelength (λ) measured by the instrument, τ_R is the Rayleigh optical depth due to the molecular scattering, m_R is the Rayleigh air mass, τ_{gas} is the absorption by atmospheric gases in the affected wavelengths (O_3 , NO_x , SO_x , etc.) and m is the air mass of different gases.

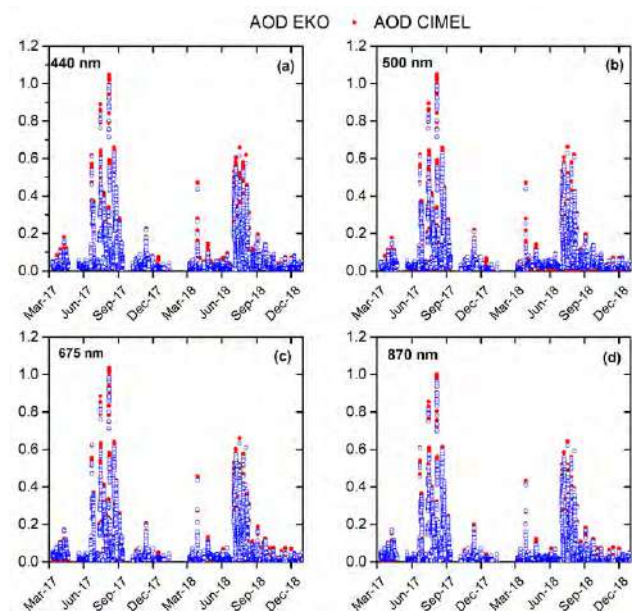

Figure 20.1. Time series of AOD estimated from EKO MS-711 (blue dots) and AOD performed with CIMEL (red dots) at (a) 440, (b) 500, (c) 675 and (d) 870 nm at Izaña Observatory between March 2017 and December 2018 (N = 10923 data).

We have determined the AOD EKO at the same wavelengths as those of the CIMEL measurements (440, 500, 675 and 870 nm) following the methodology used by AERONET (Holben et al., 2001). The results show, in general, that there is a good agreement between AOD CIMEL and the AOD EKO with the root mean square error (RMSE) < 0.01 and Pearson coefficient > 0.991 for all wavelengths. These values are within the CIMEL instrumental uncertainty (± 0.01 for masters and ± 0.02 for field instruments under conditions of clear skies (Eck et al., 1999) (Fig. 21.1).

20.2.2 Water Vapour

In the near-infrared spectrum, around 940 nm, there are many PWV absorption bands. The PWV transmittance (T_w) can be expressed taking into account the Beer-Lambert law as follows:

$$DNI(\lambda) = DNI_o(\lambda)e^{[-\tau(\lambda)m]}T_w$$

where T_w is given by:

$$T_w = DNI(\lambda)e^{(m_R\tau_R+m_a\tau_a)}$$

where τ_a is the aerosol optical depth and m_a is the relative optical air mass of aerosol. In order to convert T_w in PWV we used the three parameter expression found in Ingold et al. (2000):

$$T_w = ce^{-ax^b}$$

Where:

$$x = \frac{um_w}{u_0}$$

with $u_0 = 10 \text{ km m}^{-2}$, u is PWV and m_w is the water vapour air mass. a , b and c are constants determined by fitting the weighted water vapour transmittances simulated by a radiative transfer model. Finally, PWV is expressed from the following equation:

$$PWV = \frac{1}{m_w} \left[\frac{\ln\left(\frac{T_w}{c}\right)}{-a} \right]^{\frac{1}{b}}$$

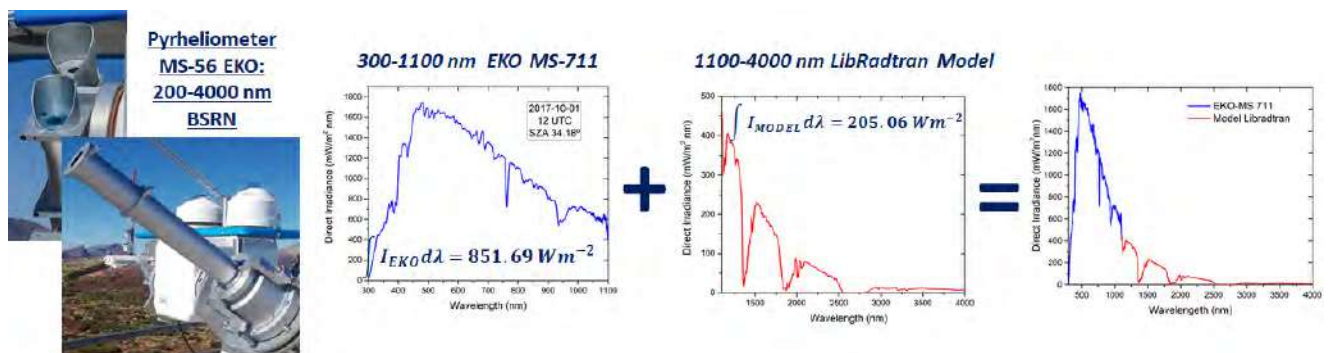

Figure 20.3 Direct radiation determined from EKO MS-711 DNI at Izaña Observatory on 1 October 2017 at 1200 UTC (SZA 34.18°).

In order to validate the results, we have compared the PWV EKO with radiosonde (RS92), FTIR, GPS and CIMEL (Fig. 21.2). In general, the results show that there is a good agreement between PWV EKO and PWV RS92, FTIR and GPS with mean biases (MB) of 0.44 (8.4%), -0.32 (-6.3%) and 0.45 mm (8.9%), respectively. Lesser agreement is obtained when comparing with the PWV CIMEL (Fig. 21.2d), with a mean bias of 1.37 mm (33.8%).

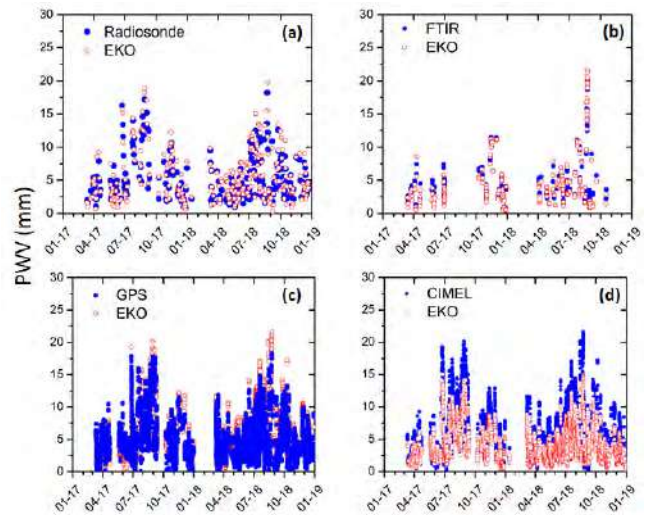

Figure 20.2. Time series of PWV estimated from EKO MS-711 (red dots) and PWV performed with different techniques (blue dots) (a) radiosonde (RS92) (N data: 292), (b) FTIR (N data: 333), (c) GPS (N data: 6679) and (d) CIMEL (N data: 10146) at IZO between March 2017 and December 2018.

20.2.3 Direct Radiation

From DNI performed with EKO MS-711, we have determined the total direct radiation and compared it with the direct radiation measured with the MS-56 pyrhelometer belonging to the BSRN (see Section 10.1). We have extended the measurements of DNI between 1100 and 4000 nm with LibRadtran to be comparable to the wavelength range of both instruments (Fig. 21.3) (García et al., 2014). Between the direct radiation estimated from EKO MS-711 and performed with MS-56 pyrhelometer we have found a good agreement with a Pearson coefficient of 0.998 and slope of 1.006 for 214 clear-days between March 2017 and December 2018.



Figure 20.4. View of the radiation/aerosol instruments on the IZO instrument terrace (Photo: C. Bayo).

20.3 The reconstruction of a 77-year time series of AOD at 500 nm by using artificial neural networks

The reconstruction of a 77-year time series of AOD at 500 nm at IZO has been achieved by using artificial neural networks (ANNs) from 1941 to 2001 and AOD measurements from AERONET (Cimel photometer) between 2003 and 2017.

The ANN method has proved to be a very useful tool for the reconstruction of daily AOD values at 500 nm from meteorological input data, such as the horizontal visibility, fraction of clear sky, and relative humidity, recorded at IZO. This methodology could be extrapolated to other sites, especially those affected by high dust loads. See Section 9.3.2 and García et al. (2016; 2018) for more details.

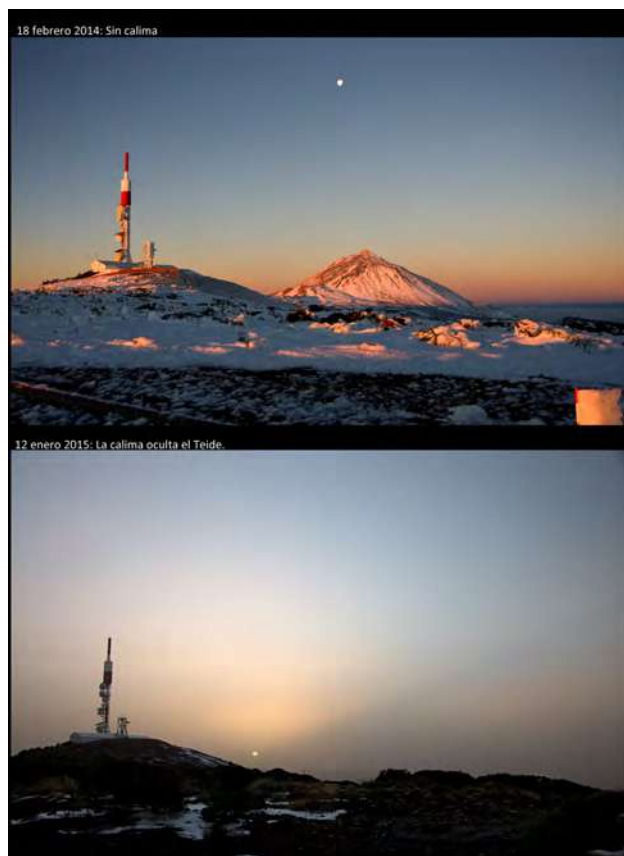

Figure 20.5. Contrasting atmospheric conditions covering a broad range of aerosols burden make Izaña Atmospheric Observatory a key site for aerosol remote sensing instruments testing and calibration: pristine conditions (upper panel) and significant dust load (lower panel) (Courtesy of S. Rodríguez).

20.4 Lunar Photometry

The Lunar Photometer research group, established in 2011 between Cimel Electronique and the Izaña Atmospheric Research Center, is focused on the design and implementation of new strategies to tackle the problems to monitor atmospheric aerosols and water vapor content at night. The most important obstacles to overcome are the low incoming energy from the Moon, the variation of the Moon's illumination inherent to the lunar cycle, as well as the non-lambertian reflectance properties of this celestial body.

In this regard, the Lunar-Langley Method (Barreto et al., 2013a) has emerged as a useful tool to perform an accurate calibration of lunar photometers, and the CE318-U prototype was developed as an instrument capable to obtain aerosol optical depth (AOD) and precipitable water vapor (PWV) with similar accuracy to daytime measurements. Further efforts led to the development of the first sun-sky-lunar photometer (trade name CE318-T) in 2014. This new instrument is able to perform daytime and nighttime photometric measurements using both the Sun and the Moon as light source, allowing the extraction of a complete diurnal cycle of aerosol properties and water vapor content, valuable to enhance atmospheric monitoring.

IARC CE318-T observations started in 2014, with three prototypes installed at IZO: one reference instrument and two secondaries. The reference, assumed as CE318-T master, is currently working as IZO master. The two CE318-T secondaries were used to develop and check new procedures to transfer the absolute Lunar Langley calibration technique to field instruments. The information extracted from these three years of CE318-T observations has allowed the comprehensive assessment of the CE318-T performance, and in addition, has served to identify other sources of problems related to lunar photometry.

As a result of this analysis, the AERONET team accepted this new Cimel version henceforth in AERONET, once the homogeneity of the network was ensured, suggesting the replacement of CE318-N instruments by the new CE318-T as far as possible (see the news published on 2 Oct. 2016, on the AERONET [webpage](#)).

20.4.1 Assessment of nocturnal Aerosol Optical Depth from lunar photometry

Moon photometry has arisen as a useful tool for a daily and continuous aerosol monitoring, especially at high latitudes. A precise Moon irradiance model is mandatory in lunar photometry, to take the continuous change of Moon's brightness over the cycle into account. The Robotic Lunar Observatory (ROLO) model, published by Kieffer and Stone (2005) is considered an essential tool for Moon photometry. However, very limited studies exist in the literature focused on the application of this model to night-time data as well as to study the model contribution to the aerosol optical depth (AOD) uncertainty.

Barreto et al. (2017) performed a first analysis of the systematic errors observed in the AOD retrieved at night-time using lunar photometry and calibration techniques dependent on the lunar irradiance model. In this respect, this work is a first attempt to correct these AOD uncertainties through an empirical regression model. To this end, nocturnal AOD measurements were performed in 2014 using the CE318-T master Sun-sky-lunar photometer (Lunar-Langley calibrated) at Izaña high mountain Observatory. This information has been restricted to 59 nights characterized as clean and stable according to MPL-3 lidar vertical backscattering profiles. The MPL-3 lidar is installed at the Santa Cruz Observatory.

A phase angle dependence as well as an asymmetry within the Moon's cycle of the ROLO model could be deduced from the comparison in this 59-night period of the CE318-T calibration performed by means of the Lunar-Langley and the calibration performed every single night by means of the common Langley technique (Fig. 21.6).

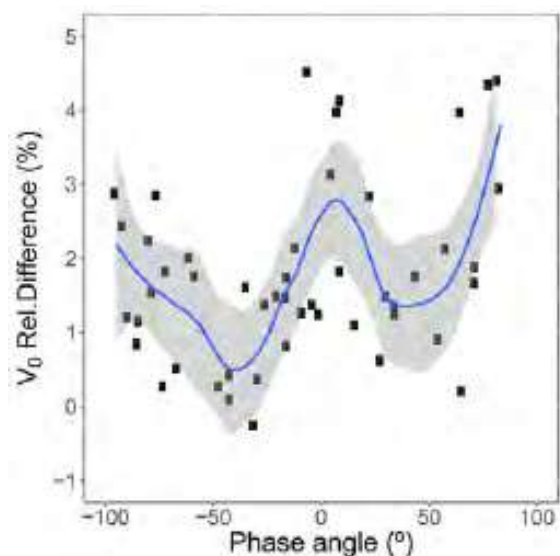

Figure 20.6. Calibration coefficients (V_0) relative difference (%) at 870 nm when Langley and Lunar-Langley absolute calibration techniques are compared. Smoothing by means of LOESS (locally estimated scatterplot smoothing) is shown with solid line. The shaded areas represent the 95% confidence interval.

Once the existence of a bias in the lunar irradiance model (which introduces calibration and AOD uncertainties dependent on Moon's phase angle) was verified, these authors proposed an empirical correction method for the AOD retrieval at night-time. To do that, nocturnal AOD has also been compared in the same period with a reference AOD based on daylight AOD extracted from the AERONET network at the same station. Considering stable conditions, the difference between AOD from lunar observations and the linearly interpolated AOD (the reference) from daylight data (ΔAOD_{fit}), has been calculated.

The results show that ΔAOD_{fit} values are strongly affected by Moon phase and zenith angles. This dependency has been parameterized using an empirical model with two independent variables (Moon phase and zenith angles) in order to correct the AOD for these residual dependencies. The correction of this parameterized dependency has been checked at four stations with quite different environmental conditions (Izaña, Lille, Carpentras and Dakar) showing a significant reduction of the AOD dependence on phase and zenith angles, and an improved agreement with daylight reference data. An example of the impact of this empirical correction to nocturnal data is shown in Fig. 21.7, where the authors present the AOD evolution in one Moon cycle in Izaña in June, 2014, before and after the AOD correction.

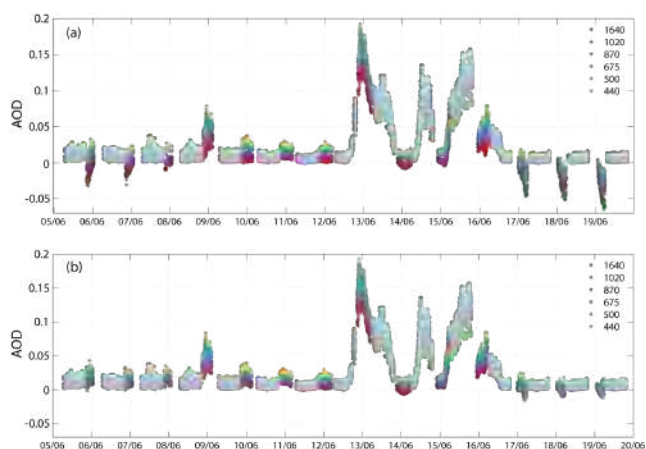

Figure 20.7. AOD evolution for one Moon cycle (June, 2014) at Izaña. Opaque colors represent daylight data. Nocturnal AOD before (a) and after (b) correction is plotted.

Barreto et al. (2017) concluded that, for the four sites under study, absolute AOD differences for day-night-day clean and stable transitions after this empirical correction remain below 0.01 for all wavelengths.

20.4.2 Lunar Photometry Campaign and Workshop Izaña 2017

On 1-17 June 2017, a Lunar Photometric Campaign was hosted at the Izaña Atmospheric Observatory. In addition, on 7-8 June 2017, a workshop on the same theme was held at IZO. These events were organized by the Izaña Atmospheric Research Center and the Atmospheric Optics

Group of Valladolid University in the framework of the WMO-CIMO Testbed for Aerosols and Water Vapour Remote Sensing Instruments.



Figure 20.8. Instruments taking measurements of the moon during the 2017 lunar photometric field campaign (left: the Cimele CE318-T and right: the stellar photometers).

The importance of the atmospheric aerosol effect on the climate has been known by the scientific community for several decades. However, the main ground-based methodology used to characterize the atmospheric aerosol, solar photometry, is not able to provide information at night or for long periods in polar areas and in high latitude stations. This lack of information reduces the ability of scientists to study the diurnal dynamics and evolution of atmospheric aerosols and other atmospheric features at high latitudes such as the Arctic haze. The incorporation of nocturnal information to the current aerosol ground-based monitoring networks would add important information to the aerosol transport models, either by assimilation or validation studies, in addition to the validation of satellite products.

The objective of this campaign was to intercompare the instruments and procedures currently being used to determine the aerosol optical thickness at night. This campaign involved the participation of several groups: IARC, GOA-UVA, Photons (University of Lille, France), the World Radiation Center (PMOD/WRC) in Davos (Switzerland), the Institute of Atmospheric Sciences and Climate of Italy, the French company CIMEL electronique (manufacturer of the CE318T photometers used in the AERONET network), the company SIELTEC Canarias, (manufacturer of the SONA All Sky camera), the Meteorological State Service of Germany, the Atmospheric Physics Group of the University of Granada and the Astrophysics Institute of the Canary Islands. The last two groups participated with instruments that use stars instead of the Moon to determine the aerosol optical thickness. The IARC also has a micro-pulsed Lidar capable of providing aerosol information at night.

During the Workshop, the most appropriate methodologies to obtain optimal results with the lunar photometers were discussed. This meeting facilitated the exchange of ideas and experiences between participants in order to promote the research in this area. Groups from the United States Geological Survey, the NASA AERONET group, the University of Sherbrooke of Canada, the Institute of Physics of the Czech Academy of Sciences and the Finnish Meteorological Institute also participated in the Workshop.



Figure 20.9. Participants of the lunar photometry workshop, Izaña, 7-8 June 2017.

20.4.3 ESA project: lunar spectral irradiance measurement and modelling for absolute calibration of Earth Orbiting optical sensors

The ROLO model has been found to be the most reliable extraterrestrial lunar irradiance model so far. However, some comparison exercises have proven that the ROLO model has an uncertainty in the absolute scale of 5-10 %, which might be related to the absolute calibration of the model derived from observations of the star Vega. There is another possible source of errors related to the atmospheric extinction correction. The different zenith angle for the Moon and Vega during this star-based calibration method leads to lunar reflectance spectra with unexpected band-to-band deviations, introducing the spectral (absolute) band scalings.

This uncertainty in the model appears as a systematic error (bias) but it is hypothesized that there exists also a phase angle dependence of the ROLO calibration (up to 6% according to Vitticchie et al. (2013) when comparing ROLO and SEVERI lunar irradiances). Other authors found a similar dependence with phase angle (Vitticchie, 2013, Lacherade, 2014, Barreto et al. 2016). It is inconclusive as to whether the systematic error was the result of instrument calibration of the instruments involved in such comparisons or errors with the ROLO model itself.

The conclusion of all these previous works is that the uncertainty of the ROLO model for absolute spectral irradiance is poorer (5-10%) than for relative spectral

irradiance ($\approx 1\%$). The long-term aim should be to provide SI-traceable absolute irradiance for the Moon.

Due to the excellent photometric stability of the lunar surface, any model which provides an absolute irradiance of the Moon, accounting for phase and libration, could indeed be used to re-calibrate and re-analyze historical data for any satellite that routinely obtained images of the Moon. This would result in a much higher degree of accuracy of our historical climate record and reduce the uncertainty in our climate forecast. This is the main reason for the ESA project launched in 2017.

The objective of this project is to use ground-based measurements taken with a Cimel CE318-TP sun-moon-sky photometer to improve upon the modelling of the lunar disk irradiance variations through its cycles (to $< 2\%$ uncertainty), including polarization measurements. This project involves nocturnal measurements at the high-mountain stations IZO and TPO (2373 and 3555 m a.s.l., respectively), precise calibration at a National Metrology Institute (NPL, London), and high-quality correction for atmospheric effects to obtain extra-terrestrial lunar irradiance. This project is currently ongoing, and it is planned to continue for at least 4 more years (until 2023), to account for the phase/libration lunar cycle.

This project was assigned to a consortium of three members: University of Valladolid/Izaña Atmospheric Research Center, National Physical Laboratory (NPL, London) and Flemish Institute for Technological Research (Vlaamse Instelling voor Technologisch Onderzoek, Belgium).



Figure 20.10. Participants in the ESA project in a meeting held in Tenerife, March 2018.

20.5 Design, development and testing of a new low-cost and robust zenith-looking multi narrow-band radiometer for AOD and water vapor retrieval.

A look-up table (LUT) methodology for AOD retrieval from zenith sky radiance has been developed and applied to AERONET Cimel sunphotometers from Santa Cruz de Tenerife, Izaña and Tamanrasset (Algeria) validating the

results against AERONET AOD. The LUT was optimised for mineral dust aerosols. The methodology has been applied to a new low-cost and robust zenith-looking multi narrow-band radiometer developed in collaboration with SIELTEC S.L. company. Estimated AOD with the new prototypes demonstrated good results when validated against reference AOD from AERONET (Almansa et al., 2017).

During 2018, we worked with a second improved version of the ZEN radiometer, the ZEN-R52, with a new design to minimize the reflections of sunlight inside the radiometer and that incorporates a new filter for the precipitable water vapor determination. Preliminary results show that this new prototype significantly improves AOD measurement of ZEN-R41 proo consequence of reducing the field of view and a better stray light rejection. A new cloud screening algorithm has been also developed being validated with lidar and total-sky cameras. The agreement of PWV from ZEN-R52 with PWV from AERONET and GNSS is excellent. A detailed description of the ZEN-R52 prototype and new products evaluation results will be subject of a scientific paper to be published in 2019-2020.

20.6 Validation of AOD in UV range using double Brewer spectrophotometers.

A new AOD product in the UV range has been developed and assessed using the Izaña Testbed facilities and ancillary data. In this project the AOD algorithm applied to instruments of the European Brewer Network has been implemented. This network is comprised of close to 50 Brewer spectrophotometers, mostly located in Europe and adjacent areas, although instruments operating in, for example, South America and Australia are also members. Using data from the Brewer intercomparison campaigns plus comparisons with Cimel sun photometers and UVPFR instruments, the precision, stability, and uncertainty of the Brewer AOD in the ultraviolet range from 300 to 320 nm was determined. Our results show a precision better than 0.01, an uncertainty of less than 0.05, and, for well-maintained instruments, a stability similar to that of the ozone measurements.

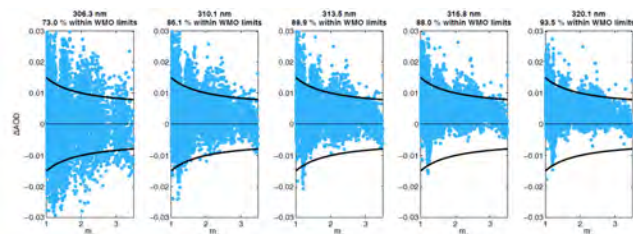

Figure 20.11. AOD differences between observations within 1 minute of the independently-calibrated Brewers #183 and #185, plotted as a function of the aerosol optical air mass. The WMO traceability limits for finite field of view instruments are shown as thick black lines. Reprinted from López-Solano et al. (2017).

Future improvements to our algorithm with respect to the input data, their processing, and the characterization of the Brewer instruments for the measurement of AOD were also assessed. The main results of the new algorithm and corresponding validations are described in López-Solano et al., 2017.

20.7 Low-cost hand-held sunphotometer assessment

TENUM is a French company that has designed and manufactured a small educational sun-photometer named Calitoo. This instrument has been developed under the scientific and technical supervision of Dr. Phillippe Goloub and Eng. Luc Blarel from LOA (CNRS-University of Lille). Calitoo sun-photometers are used in the Global Learning and Observations to Benefit the Environment (GLOBE) program, which is a worldwide hands-on, primary and secondary school-based science and education program (see Section 22.2).

After manufacturing, the sun-photometers must be periodically calibrated to provide AOD measurements. In the periods 26 June – 3 July 2017 and 18-27 June 2018, a total of 200 Calitoo sun-photometers were calibrated using the Langley method at IZO. Furthermore, the new developments performed in the Calitoo were also tested at Izaña: new software capabilities, a real-time Angstrom Exponent computation and analysis, as well as the Calibot (CALItOO – roBOT) system for automatic sun tracking (still in testing phase).



Figure 20.12. Top left and right, Calitoo sun photometer calibration campaigns in 2017 and 2018 at Izaña Atmospheric Observatory. TENUM Calitoo activities at IARC: preparations and measurements for Langley calibration performed by Frederic Bouchar and Stéphane Villeneuve (bottom left) and Calibot tests (bottom right) (images courtesy of TENUM).

20.7.1 Potential use of low-cost hand-held sunphotometers for operational activities

Currently, five Calitoo sun-photometers are used in experimental campaigns promoted by IARC. The objective is to provide a comprehensive assessment of the potential use of the very low-cost Calitoo-TENUM hand-held sun-photometer for operational dust model and satellite observation validation activities within the WMO SDS-WAS.

- 1) Since February 2017, a Calitoo has been taking measurements in the heart of the Sahara Desert at the Tamanrasset World Meteorological Organization - Global Atmospheric Watch (GAW) station (Algeria) (see Section 20).
- 2) Two Calitoos are currently being used in Iran in a pilot project in collaboration with the Islamic Republic of Iran Meteorological Organization (IRIMO). One in the urban Tehran megacity station since November 2016 to monitor aerosol pollution and the impact of dust outbreaks on the city. Another one has been taking measurements in the Mt. Aminabad (Firoozkoh) regional GAW station since January 2018.
- 3) Since March 2018, a Calitoo has been operating on board the oceanographic vessel “Ángeles Alvariño” from the Spanish Institute of Oceanography (IEO). This Calitoo is taking maritime measurements in the Atlantic Ocean, from Canary Islands to Galicia, as well as in the Mediterranean Sea, from Cataluña to Andalucía.
- 4) An additional Calitoo is currently operating in the AEMET facilities in Gran Canaria for testing its feasibility for operational issues in weather observations and forecasting. This experience might be extended to meteorological observatories of many airports in North Africa in the future to provide additional information in Synop and METAR observations for dust model evaluation and data assimilation.

20.8 Development of synergy photometer/lidar methodologies for retrieving vertical aerosol extinction.

The Fernald-Klett method is commonly used to derive aerosol optical properties profiles from elastic lidars together with AOD measurements from a collocated photometer. This method assumes a range independent lidar ratio, which involves an aerosol vertical distribution with range invariant physico-chemical properties. However this approximation may be unrealistic when we find different aerosol types at different heights. This situation can be improved with additional measurements and previous knowledge about the aerosol vertical distribution.

We analyzed a decade of lidar and photometric data at two heights from the observatories of IZO and SCO. This region

is characterized by a quasi-permanent thermal inversion which separates the troposphere into two layers: the marine boundary layer and the free troposphere. As a result, two layers with different lidar ratios have been considered in this study (Two-layer method). The results are compared with the classical one-layer analysis (One-layer method).

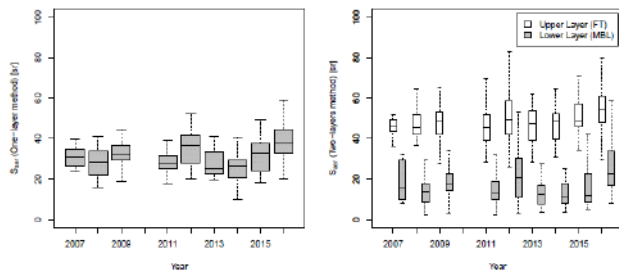

Figure 20.13. Lidar ratio at 523 nm from one-layer (left) and two-layer methods (right) for each year between 2007 and 2017. The central rectangles extend from the first quartile to the third quartile and the median is represented by a horizontal line. The whiskers are defined as the upper and lower quartiles ± 1.5 IQR (inter-quartile range). Reprinted from Berjón et al. (2019).

Our results suggest the suitability of the Two-layer method to estimate aerosol backscattering and extinction profiles $\beta_{\text{aer}}(r)$ and $\sigma_{\text{aer}}(r)$, respectively, in those situations where different aerosol layers exist in the vertical. The lidar ratio obtained by means of the Two-layer method was also validated with the value derived independently from the sun/sky photometer 15 at IZO, with a good agreement between the two techniques (mean discrepancies about 1 sr). This project was developed during 2017-2018 and the results were published by Berjón et al. (2019).

20.9 References

- Almansa, A. F., Cuevas, E., Torres, B., Barreto, Á., García, R. D., Cachorro, V. E., de Frutos, Á. M., López, C., and Ramos, R.: A new zenith-looking narrow-band radiometer-based system (ZEN) for dust aerosol optical depth monitoring, *Atmos. Meas. Tech.*, 10, 565-579, doi:10.5194/amt-10-565-2017, 2017.
- Barreto, Á., Román, R., Cuevas, E., Berjón, A. J., Almansa, A. F., Toledano, C., González, R., Hernández, Y., Blarel, L., Goloub, P., Guirado, C., and Yela, M.: Assessment of nocturnal aerosol optical depth from lunar photometry at the Izaña high mountain observatory, *Atmos. Meas. Tech.*, 10, 3007-3019, https://doi.org/10.5194/amt-10-3007-2017, 2017.
- Berjón, A., Barreto, A., Hernández, Y., Yela, M., Toledano, C., and Cuevas, E.: A 10-year characterization of the Saharan Air Layer lidar ratio in the subtropical North Atlantic, *Atmos. Chem. Phys.*, 19, 6331–6349, https://doi.org/10.5194/acp-19-6331-2019, 2019.
- García, R. D., Cuevas, E., García, O. E., Ramón, R., Romero-Campos, P. M., de Ory, F., Cachorro, V. E., and de Frutos, A.: Compatibility of different measurement techniques of global solar radiation and application for long-term observations at Izaña Observatory, *Atmos. Meas. Tech.*, 10, 731-743,

doi:10.5194/amt-10-731-2017, 2017a. https://www.atmos-meas-tech.net/10/731/2017/amt-10-731-2017.html.

García, R.D., E. Cuevas, A. Barreto, V. Cachorro, R. Ramos, C. Guirado, C. Toledano and K. Hoogendijk,: Preliminary results of Aerosol Optical Depth and Angstrom Exponent at the Izaña Atmospheric Observatory from spectral direct irradiance measured with an EKO MS-711 spectroradiometer, 44th Annual European Meeting on Atmospheric Studies by Optical Methods, 4-8 September, Barcelona, Spain, 2017b.

García, R. D., Barreto, A., Cuevas, E., Gröbner, J., García, O. E., Gómez-Peláez, A., Romero-Campos, P. M., Redondas, A., Cachorro, V. E., and Ramos, R.: Comparison of observed and modelled longwave downward radiation (2010–2016) at the high mountain BSRN Izaña station, *Geosci. Model Dev. Discuss.*, https://doi.org/10.5194/gmd-2017-303, 2018.

López-Solano, J., Redondas, A., Carlund, T., Rodríguez-Franco, J. J., Diémoz, H., León-Luis, S. F., Hernández-Cruz, B., Guirado-Fuentes, C., Kouremeti, N., Gröbner, J., Kazadzis, S., Carreño, V., Berjón, A., Santana-Díaz, D., Rodríguez-Valido, M., De Bock, V., Moreta, J. R., Rimmer, J., Smedley, A.R.D., Boulkelia, L., Jepsen, N., Eriksen, P., Bais, A. F., Shirovov, V., Vilaplana, J. M., Wilson, K. M., and Karppinen, T.: Aerosol optical depth in the European Brewer Network, *Atmos. Chem. Phys. Discuss.*, https://doi.org/10.5194/acp-2017-1003, in review, 2017.

Romero-Campos, P.M., Cuevas-Agulló, E., Kazadzis, S., Kouremeti, N., García-Cabrera, R. D., Guirado-Fuentes, C., Análisis de la trazabilidad en los valores del AOD obtenidos a partir de las medidas de las redes AERONET-CIMEL y GAW-PFR durante el período 2005-2015 en el Observatorio Atmosférico de Izaña, Agencia Estatal de Meteorología (AEMET), *Notas técnicas de AEMET*, 23, 2017. http://hdl.handle.net/20.500.11765/7572.

20.10 Staff

- Dr Emilio Cuevas (AEMET; PI of Testbed)
- Ramón Ramos (AEMET; Head of Infrastructure)
- Pedro Miguel Romero Campos (AEMET; Research Scientist)
- Dr Rosa García (AIR LIQUIDE; Research Scientist)
- Dr Carmen Guirado Fuentes (UVA/AEMET; Research Scientist) left IARC in September 2019
- Dr Africa Barreto (CIMEL/AEMET/UVA; Research Scientist)
- Antonio Fernando Almansa (CIMEL/AEMET; Research Scientist)
- César López Solano (SIELTEC)
- Dr Omaira García (AEMET; Research Scientist)
- Dr Victoria Cachorro (University of Valladolid; Head of Atmospheric Optics Group)
- Dr Matthias Schneider (KIT-IMK, Research Scientist)

21 Capacity Building Activities

During 2017-2018 IARC participated in various capacity building activities, some of which are described here. For further details of these activities, see individual sections or the IARC [webpage](#).

21.1 Training course on “Atmospheric Aerosols and Mineral Dust”: Izaña, Tenerife, 20 June – 6 July 2017

The training course was organized by the IARC as a cooperation activity between Spain and Iran in the framework of SDS-WAS. Dr Saviz Sehat Kashani, Academic member of Atmospheric Science and Meteorological Research Center (ASMERC) of the Islamic Republic of Iran Meteorological Organization (IRIMO) attended the course.

Dr Sehat received information on the SDS WAS programme, mineral dust observations, and on complementarities and synergies with the WMO GAW programme from Dr Emilio Cuevas. Dr Africa Barreto introduced main concepts on the lidar technique. Dr Carmen Guirado-Fuentes was in charge of detailing operational and research aspects of solar photometry technique and on activities carried out at the optical laboratory. Detailed information of techniques, methodologies, and science on in-situ aerosols were provided by Dr Sergio Rodríguez and his team, Dr Elisa Sosa and Dr Isabel García. Fernando Almansa introduced measurement methodology of the new zenith-looking narrow-band radiometer-based system (ZEN) for dust aerosol optical depth monitoring.

Dr Sehat received first-hand information about Calitoo's new software and developments from Tenum engineers who were at Izaña in a calibration campaign. Finally, Dr Sehat had the opportunity to participate in the workshop “ACE20: Future North Atlantic Atmospheric Observation Systems. Assessing the legacy of ACE2” (see Section 25 for further details).



Figure 21.1. Dr Saviz Sehat with Dr Carmen Guirado-Fuentes on the terrace of the Izaña Observatory observation tower.

21.2 Calima project

The Ministry of Education and Universities of the Canary Islands Government and the IARC initiated in 2018 a joint project to raise awareness of the problem of airborne dust and its impacts on health and the environment throughout the educational community. This project, called “Calima”, complements another initiative of the Ministry of Education and Universities, the Clima project. “Calima” project includes the pioneering use of remote sensing instruments, and specifically low cost sun photometers designed and produced for the GLOBE (Global Learning and Observation to Benefit the Environment) project. These photometers are Calitoo models, manufactured by Tenum (Fig. 22.2). The Canary Islands Government has purchased 10 of these photometers that have been calibrated and checked at the Izaña Observatory.



Figure 21.2. Calitoo hand-held photometer model used in the Calima Project.

The secondary schools that have joined the project are routinely measuring aerosol optical depth, using low-cost radiometers. They are sending their results to a centralised database that has been developed within the IARC. This database will be used by AEMET, and specifically by the WMO Sand and Dust Storm Warning Advisory and Assessment System, managed by AEMET and by Barcelona Supercomputing Centre.

At the same time, AEMET is providing AOD forecast information for each and every one of the secondary schools that participate in the Calima project, as well as the aerosols data obtained from the satellite, so students can practice comparing their data with the atmospheric dust forecast.

On 12 April 2018, Izaña observatory hosted a workshop attended by the teachers from the eight Canary Islands. Dr Emilio Cuevas, Mr Enric Terradellas and Dr Carmen Guirado-Fuentes introduced the concepts of aerosols, photometry and visibility, the SDS-WAS programme, as well as the practical use of low-cost sun-photometers.



Figure 21.3. Calima project workshop held at the Izaña Observatory, 12 April 2018.



Figure 21.4. Group photo of the Calima project workshop participants, Izaña Observatory, 12 April 2018.

The photometers are located to completely cover all the islands in the Canary archipelago (Fig. 22.5), preferably in sunny areas of each island as clear skies are needed to take measurements. In the bigger islands, Tenerife and Gran Canaria, there are two photometers operating, one close to the coastline and the second at higher altitudes.

The 10 educational centres participating in the Calima project in the eight Canary Islands are listed below:

- El Hierro - Instituto de Educación Secundaria (IES) Garoe
- Fuerteventura - IES Jandía
- Gran Canaria - Centro de Educación Obligatoria (CEO) Tejeda and IES Amurga
- La Gomera - Colegio de Educación Infantil y Primaria (CEIP) Ruiz de Padrón
- La Graciosa - CEO Ignacio Aldecoa
- La Palma - IES Las Breñas
- Lanzarote - IES Yaiza
- Tenerife - IES Los Cristianos and CEO Vilaflor

On 22 October 2018, a meeting was held at CEIP La Laguna to restart the project activities at the beginning of the school year. Furthermore, Antonio Cruz Martín (IARC-AEMET) introduced the web application and associated database to upload the Calitoo data taken at the Educational Centres (<http://testbed.aemet.es/calimaview/>). An example of the data collected for 1/9/2018-1/1/2019 is shown in Fig. 22.6 for IES Yaiza in Lanzarote and IES Los Cristianos in Tenerife.

These activities are financed by the Ministry of Education and Universities of the Canary Islands Government, with the advice and support of AEMET through the Izaña Atmospheric Research Centre. Also, they are partially supported by the Global Learning and Observation to Benefit the Environment programme, the InDust COST Action and the WMO Sand and Dust Storm – Warning Advisory and Assessment System.



Figure 21.5. Location of the 10 educational centres participating in the Calima project in the Canary Islands

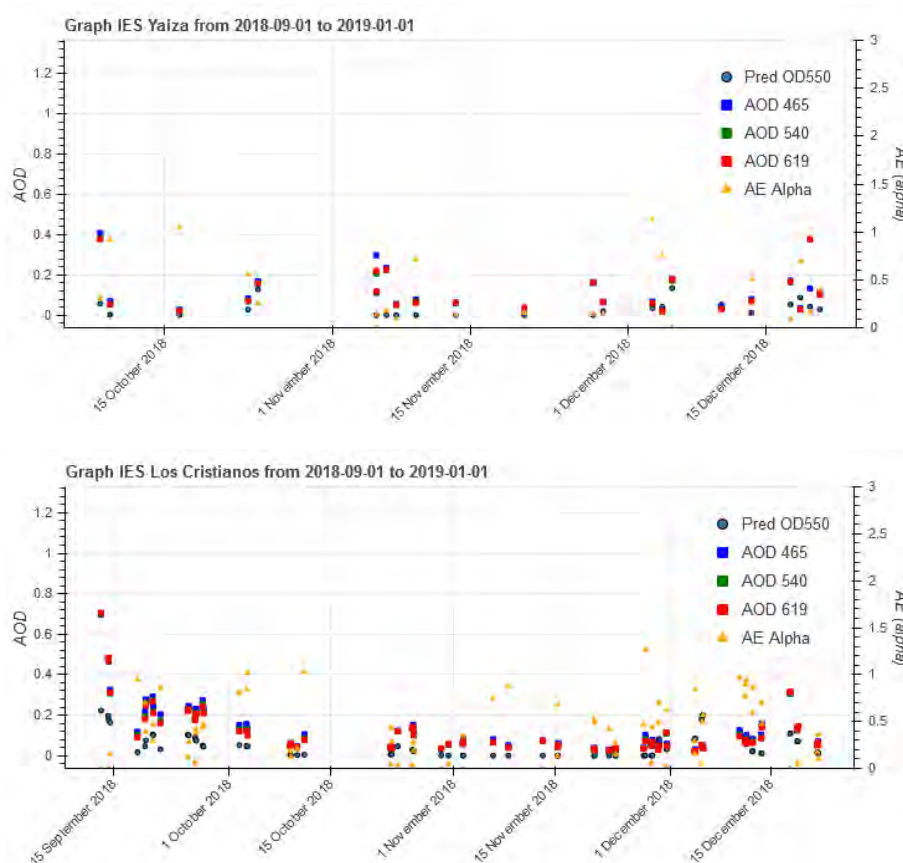

Figure 21.6. Example of measurements available in the web application of the project (Calima Project Graph View). Aerosol optical depth (AOD) at 465 m, 540 nm and 619 nm, Angstrom exponent (alpha) measured at a) IES Yaiza and b) IES Los Cristianos, plotted together with BSC dust forecast at 550 nm (Pred OD550) for 1/9/2018-31/12/2018.

21.3 Training Course on “Observation and Prediction of Air Quality”: Santa Cruz de la Sierra, Bolivia, 15-26 October 2018

Dr Natalia Prats Porta (IARC-AEMET) participated in a training course, organized and coordinated by AEMET and AECID, entitled: “Observation and Prediction of Air Quality” held in Santa Cruz de la Sierra, Bolivia, during 15-26 October 2018.



Figure 21.7. Observation and Prediction of Air Quality training course, Santa Cruz de la Sierra, Bolivia, 15-26 October 2018.

22 Scientific Communication

The main tool of scientific communication of the IARC is, undoubtedly, its webpage (<http://izana.aemet.es>). Scientific information and articles are regularly posted. Also there is a Wikipedia [page](#). In this section, we give details of some of the science communication activities during the 2017-2018 period.

22.1 HIRLAM Management Group Meeting: 1 February 2017

The High Resolution Limited Area Model Consortium (HIRLAM) was established in 1985, and it is integrated by the National Meteorological Services from Denmark, Estonia, Finland, Iceland, Ireland, Lithuania, Holland, Norway, Spain and Sweden, with France as an associated member. This group has participated in the development and exploitation of a high resolution numerical weather prediction system for operational use in weather forecast, in which AEMET has participated since 1997. The HIRLAM Management Group visited the Izaña Observatory on 1 February 2017, during the regular Management Group Meeting. In this visit, the HIRLAM Management Group appreciated the potential possibilities of the Izaña facilities as a Numerical Weather Prediction System evaluation/calibration platform.

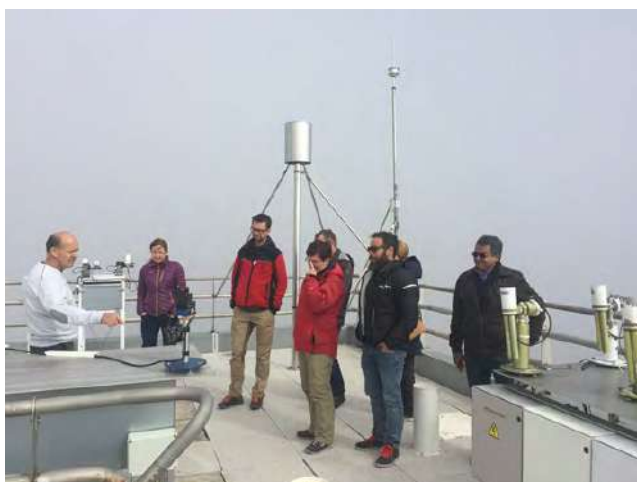

Figure 22.1. Participants of the HIRLAM Management Group on a visit to Izaña Atmospheric Observatory, 1 Feb 2017.

22.2 Teidelab presentation: 27 March 2017

Teidelab is an initiative created between the Teide Cable Car Company and various other institutions, including the Izaña Atmospheric Research Center, to produce high quality content that advances and disseminates knowledge about the natural, scientific, cultural and recreational values of Teide National Park. It seeks to facilitate collaboration between different institutions, both those with a direct presence in Teide National Park, as well as those that are particularly relevant to the interests of the Park.



Figure 22.2. Photographic images taken during the “Teide Clouds Laboratory” project from Izaña Observatory by Daniel López.

The “Teide Clouds Laboratory” project, which started in December 2015, is one of four projects within Teidelab. The project is the result of a collaboration between the IARC, the Teide Cable Car Company, and the renowned Astrophotographer Daniel López, with the main aim of registering meteorological phenomena in Teide National Park using high quality photographic images and high temporal resolution “time-lapse” videos. Cameras have been placed within the main Izaña Observatory technical tower and in a “Cloud Tower” outside the observatory to allow diurnal and nocturnal photographic images to be captured remotely (e.g. Fig. 22.2). A video presentation of the “Teide Clouds Laboratory” project can be found [here](#). On 27 March 2017, the Tenerife Government presented the Teidelab Project at the Museum of Nature and Archeology in Santa Cruz de Tenerife (Fig. 22.3).



Figure 22.3. Participants of the Teidelab Project meeting at the Museum of Nature and Archeology, 27 March 2017.

22.3 The 10th meeting of the Ozone Research Managers of the Parties to the Vienna Convention: 28–30 March 2017

The UNEP International Ozone Commission “10th meeting of the Ozone Research Managers of the Parties to the Vienna Convention”, was held in Geneva, Switzerland from 28-30 March 2017. Rimmer et al. (2017) presented an overview of the European COST Action EUBREWNET and Redondas (2017) presented the South Europe Regional Report. IARC hosts EUBREWNET, which started as a European network but now includes close to 50 stations located world-wide (see Section 6.3.1).



Figure 22.4. Participants of the UNEP International Ozone Commission “10th meeting of the Ozone Research Managers of the Parties to the Vienna Convention”, Geneva, 28-30 March 2017.

22.4 WMO Executive Council meeting: 10–17 May 2017

The May 2017 WMO Executive Council meeting recognized a first set of 60 WMO Centennial Observing Stations to highlight their role and to assist member countries in maintaining them. The Izaña Observatory was recognised in this first set of Centennial Observation Stations in 2017. Long-term meteorological observations are part of the irreplaceable cultural and scientific heritage

of mankind that serve the needs of current and future generations for long-term high quality climate records. They are unique sources of past information about atmospheric parameters, thus are references for climate variability and change assessments. To highlight this importance, WMO established the mechanism to recognize Centennial Observing Stations.

22.5 Presentation of Izaña Observatory documentary: 2 June 2017

On 2 June 2017 the documentary “Izaña, the place to find the answers” was presented at the Museum of Science and the Cosmos, La Laguna (Tenerife). This documentary was produced by AEMET to commemorate the centenary of the Observatory of Izaña, which was celebrated in 2016, and is available in both Spanish and English. The documentary describes in an informative way the current main scientific issues and atmospheric challenges and how they are approached by the scientific community, in general, and by the Izaña Observatory, in particular.

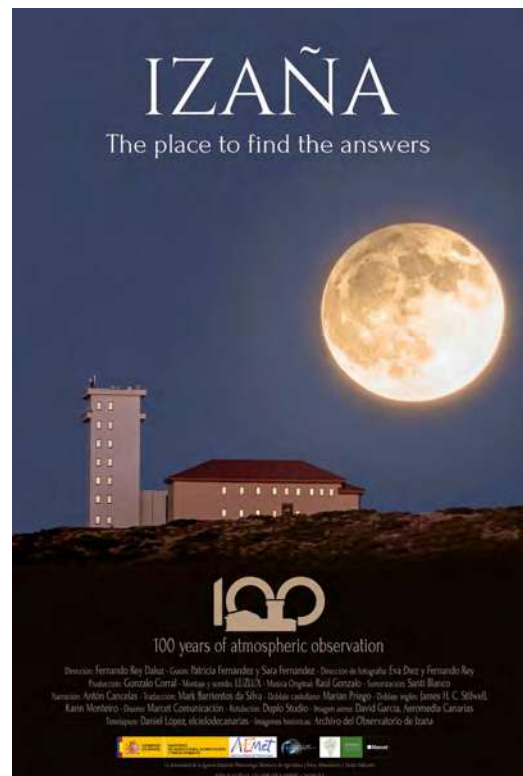

Figure 22.5. Presentation of Izaña Observatory documentary, Museum of Science and the Cosmos, Tenerife. 2 June 2017. Lower panel (from left to right) Dr Emilio Cuevas, Dr Antonio Mampaso (Museum of Science and the Cosmos, Director) and Fernando Rey Daluz (Documentary director) during the presentation.

22.6 ACE20 Workshop: Future North Atlantic atmospheric observation systems. Assessing the legacy of ACE2: 4-6 July 2017

The workshop entitled “ACE20: Future North Atlantic atmospheric observation systems. Assessing the legacy of ACE2” took place in the Hotel Mencey in Santa Cruz de Tenerife, from 4-6 July 2017. The workshop was chaired by Dr Frank McGovern (EPA), with the presence of the ACE2 (1997) project leader, Dr Frank Raes, as well as leading specialists in atmospheric processes in the North Atlantic. The ACE20 project steering committee members were Leonard Barrie, Emilio Cuevas, Joseph M. Prospero, Kjetil Tørseth and Frank McGovern. The ACE20 workshop was organized in Tenerife to commemorate the 20th anniversary of the celebration of the huge aerosol observation experiment in the North Atlantic called "The 2nd Aerosol Characterization Experiment (ACE-2)" (see Raes et al., 2000).



Figure 22.6. Participants of the ACE20 Workshop on a visit to Izaña Atmospheric Observatory, 5 July 2017.

A key objective for the 1997 ACE2 project was to increase understanding of the impacts of air pollutants on climate, focusing on the North Atlantic sub-tropical region. This was achieved by studying the properties, processes and effects of contrasting aerosol types in this region, including background marine and anthropogenic-pollution aerosols in the marine boundary layer, and background aerosols and mineral dust in the overlaying free troposphere (Raes et al., 2000). One of the accomplishments of ACE-2 was to provide a qualitative, and in many cases a quantitative understanding of the complex gas/aerosol/cloud system in the sub-tropical marine environment.

The 20 year anniversary of the ACE2 project was an opportune moment to examine the legacy of ACE2, review subsequent scientific and technical progress and consider current and emerging scientific and policy challenges in the North Atlantic Region and how they can be addressed, including options for further development of observing systems. A report on the outcome of the workshop was published by Barrie and McGovern (2018) and can be found [here](#).

22.7 Celebration of the 30th anniversary of the Montreal Protocol: 14 September 2017

The year 2017 marked the 30th anniversary of the Montreal Protocol, the international agreement that has led to the removal of more than 99% of chemical substances that produce ozone depletion.

On 14 September 2017, a series of conferences and round-table discussions were held in AEMET headquarters to commemorate the 30th anniversary of the Montreal Protocol. The commemorative events were opened by Javier Cachón de Mesa, General Director of Quality and Environmental and Natural Evaluation of MAPAMA. Next, Margarita Yela, from INTA, belonging to the Ministry of Defense, briefly explained the Montreal Protocol.

Subsequently, two round-table discussions were held. In the first discussion, moderated by Emilio Cuevas (IARC-AEMET) and in which Margarita Yela, Juan Ramón Moreta (AEMET) and Joaquín Muñoz Sabater (Copernicus) participated, the scientific approach of the Montreal Protocol was addressed. In the second discussion, which was moderated by Maj Britt Larka (MAPAMA), Óscar González (MAPAMA), Santiago González Muñoz (Ministry of Health, Social Services and Equality) and José Manuel López Aranda (UNIDO expert) discussed the positive impacts of the Protocol on health, the environment and agriculture. The presentations and round-table discussions can be found [here](#).



Figure 22.7. 30th anniversary of the Montreal Protocol, participants of the first round-table discussion, AEMET headquarters, Madrid, 14 September 2017.

22.8 Workshop on Climate Change in the Canary Islands: 22 September 2017

Dr Emilio Cuevas participated in a workshop on Climate Change in the Canary Islands and its possible impacts on agriculture entitled: “Water resources management. Solutions and technological and innovative developments”. Instituto Canario de Investigaciones Agrarias (ICIA), La Laguna, Tenerife, 22 September 2017.

22.9 Joint Research Center Resilience Workshop on Climate Change in the Canary Islands: 2-3 November 2017

The European Commission's Joint Research Centre (JRC) organised a workshop on Climate Change resilience in Tenerife on 2 and 3 November 2017. The second day of the workshop (3 Nov 2017) was held in Izaña Observatory. It was attended by a variety of people (academics, social actors and members of the public) with expertise on both the definition of the concept of 'resilience' and the implications it would have for the island of Tenerife. For this purpose, presentations, sector-specific round tables, scientific visits and discussion groups were organised (Fig. 22.8).

Hernandez et al. (2018a) sets out the main conclusions drawn from the workshop, together with a list of actions in the form of a proposal to make the island more resilient to external and internal shocks, whether climate-related or socio-economic. Other publications by Hernández-González et al. (2016) and Hernandez et al. (2017, 2018b) were utilised as background documents for this workshop. Dr Emilio Cuevas gave a presentation on "Evolution of climate change in the Canary Islands" and Dr Sergio Rodríguez gave a presentation on Air Quality in Tenerife.



Figure 22.8. Top two panels, participants of the Joint Research Center (JRC), Climate Change Resilience Workshop. Lower panel, Yera Hernández (Coordinator of the JRC initiative) giving a presentation at the Climate Change Resilience Workshop, Izaña Observatory, 3 November 2017.

22.10 Seminars on Atmospheric dust and its impacts on different sectors: 22 Nov 2017

Dr Emilio Cuevas, Dr Sergio Rodríguez and Dr Omaira García (IARC-AEMET) participated in Seminars on "Atmospheric dust and its impacts on different sectors" at AEMET headquarters in Madrid on 22 November 2017, giving the following presentations:

- Dr Emilio Cuevas: "Introducción a la problemática del polvo atmosférico". (Introduction to mineral dust)
- Dr Omaira García: "Incidencia del polvo mineral en la radiación solar y en el clima". (Mineral dust and its effect on solar radiation and climate).
- Dr Sergio Rodríguez "Transporte del polvo mineral del Sahara y su impacto en la calidad del aire". (Transport of mineral dust from the Sahara and its impact on air quality).

A video of the seminars and the following scientific discussions can be found [here](#).

22.11 The American Geophysical Union Chapman Conference on Stratospheric aerosol: 18-23 March 2018

Named in honour of Sydney Chapman, a mathematician and physicist recognized for his research in geophysics, the American Geophysical Union (AGU) Chapman Conference program has encouraged innovative research for more than four decades. AGU Chapman conferences are small, topical meetings designed to permit in-depth exploration of specialized subjects in a manner not possible at large meetings.

The AGU Chapman Conference on "Stratospheric Aerosol in the post-Pinatubo Era: Processes, Interactions and Importance" was held in Puerto de la Cruz, Tenerife from 18-23 March 2018. The local host of the conference was IARC-AEMET. More information on the AGU Chapman Conference can be found [here](#).



Figure 22.9. Participants of the Chapman Conference on Stratospheric aerosol on a visit to Izaña Observatory, 21 March 2018.

On 21 March there was an organised visit for conference participants to Izaña Atmospheric Observatory (Fig. 22.9) and the Teide Peak. This Chapman Conference on Stratospheric Aerosol focused on addressing the following scientific questions:

- How well do we understand, in volcanically quiescent periods, the sources, both gas and particle phase, of stratospheric aerosol, and the influence of non-sulfate aerosol and precursors?
- What are the climate impacts of stratospheric aerosol during non-volcanic periods?
- How well do global stratospheric aerosol climatologies capture the measurement record and the climate relevant quantities during volcanically quiescent periods?
- How well do models represent stratospheric aerosol and its climate impacts for models with prescribed aerosol climatologies and those with derived aerosol?

22.12 The 9th International Workshop on Sand/Dust storms and Associated Dustfall: 22-24 May 2018

The 9th International Workshop on Sand/Dust storms and Associated Dustfall was held in La Laguna (Tenerife, Spain) from 22-24 May 2018. The workshop was attended by 170 scientists from 37 countries (Fig. 22.10). The workshop website can be found [here](#).



Figure 22.10. Participants of the 9th International Workshop on Sand/Dust storms and Associated Dustfall, La Laguna, 22-24 May 2018.

The coordinator of the workshop was Dr Sergio Rodríguez (IARC-AEMET). The dust workshops are developed under the umbrella of the WMO SDS-WAS programme (see Section 18 for more details of SDS-WAS). The Sand & Dust-storms and Associated Dustfall Workshops are a scientific forum to analyse and discuss the state of the art research on dust, its connections to air quality, environmental impacts and climate. There were seven different sessions in the workshop covering the following broad topics:

- Sources and transport of dust
- Dust impacts
- Dust composition and properties
- Dust, radiation and clouds
- Dust and the ocean
- Dust at different scales
- Dust forecast and services.

IARC-AEMET participated in 14 oral and poster presentations (Almansa et al., 2018; Barreto et al., 2018; Basart et al., 2018; Berjón et al., 2018; Cuevas et al., 2018; De La Rosa et al., 2018; García et al., 2018; Guirado-Fuentes et al., 2018; López-Solano et al., 2018a; López-Solano et al., 2018b; Prats et al., 2018; Rodríguez et al., 2018; Saviz et al., 2018; and Sosa et al., 2018).

22.13 Presentation of the MEGEI-MAD campaign: 26 September 2018

Dr Omaira García (IARC-AEMET) presented the field campaign MEGEI-MAD during a press conference in AEMET Headquarters in Madrid on 26 September 2017. For more details of the MEGEI-MAD project and field campaign see Section 7.3.2.

Various media reports of the campaign can be found [here](#) listed under 26 and 27 September 2018.



Figure 22.11. Dr Omaira García (IARC-AEMET) during a press conference presenting the field campaign MEGEI-MAD on 26 September 2018.

22.14 References

- Almansa, A.F., Cuevas, E., Barreto, A., Torres, B. and López-Solano, C. Dust aerosol optical depth (DOD) monitoring with a ZEN-R52 radiometer: An upgraded version of ZEN-R41 prototype. 9th International Workshop on Sand/Dust storms and Associated Dustfall, La Laguna, Tenerife, Spain, 22-24 May 2018.
- Barreto, A., E. Cuevas, J. Carrillo, A. Berjón, C. Guirado-Fuentes, Y. Hernández, J. C. Guerra and M. Yela. Saharan Air Layer profiling at the Canary Islands using MPL and radiosondes, 9th International Workshop on Sand/Duststorms and Associated Dustfall, La Laguna, Tenerife, Spain, 22-24 May 2018.
- Barrie, L. A. and McGovern, F. Protecting the North Atlantic Atmosphere: A Report on the Outcome of an International Meeting on the Twentieth Anniversary of the Second Aerosol Characterisation Experiment (ACE2). Environmental Protection Agency (EPA) Ireland, Report No. 247, 2018. ISBN: 978-1-84095-773-0
- Basart, S., García-Castrillo, G., Cuevas, E., Goloub, P., Cazorla, A., Alastuey, A., Mortier, A., Benedetti, A. and Terradellas, E. Towards continuous evaluation of dust profiles in the WMO SDS-WAS. 9th International Workshop on Sand/Dust storms and Associated Dustfall, La Laguna, Tenerife, Spain, 22-24 May 2018.
- Berjón, A., A. Barreto, Y. Hernández, E. Cuevas, M. Yela. Lidar signal analysis using AOD at two heights. 9th International Workshop on Sand/Duststorms and Associated Dustfall, La Laguna, Tenerife, Spain, 22-24 May 2018.
- Cuevas, E., J.J. Bustos, S. Rodríguez, C. Marrero, E. Reyes, R.D. García, O.E. García, A. Barreto, and C. Guirado, Short-term variations of the Saharan Air Layer atmospheric properties over the North Atlantic driven by NAFDI: Summer 2017 case analysis, 9th International Workshop on Sand/Duststorms and Associated Dustfall, La Laguna, Tenerife, Spain, 22-24 May, 2018.
- De La Rosa, J.D., Rodríguez, S., García-Álvarez, M.I., Sosa, E., Salvador, A., Sánchez De La Campa, A. M., Márquez, G., Rodríguez-Aller, J. and Gil-Ibarguchi, J.I. Sr-Nd isotope composition of Saharan dust observed in the North Atlantic free troposphere. 9th International Workshop on Sand/Dust storms and Associated Dustfall, La Laguna, Tenerife, Spain, 22-24 May 2018.
- García, R.D., O.E. García, E. Cuevas and J.J. Bustos, Long-term aerosol optical depth (1941-2017) at the Izaña Observatory, 9th International Workshop on Sand/Duststorms and Associated Dustfall, La Laguna, Tenerife, Spain, 22-24 May 2018.
- Guirado-Fuentes, C., Y. Hernández, E. Cuevas, Validation of Calitoo hand-held sun photometer for aerosol characterization under background and dust conditions, 9th International Workshop on Sand/Duststorms and Associated Dustfall, La Laguna, Tenerife, Spain, 22-24 May 2018.
- Hernández-González, Y., Guimarães-Pereira, A., Rodríguez, S., Cuevas, E., and Barbosa, P. Perspectives on contentions about climate change adaptation in the Canary Islands: A case study for Tenerife. 2016. European Union, Luxembourg, EUR 28340 EN, doi: 10.2788/282252
- Hernandez, Y., Barbosa, P. and Corral, S., Scenarios for resilience and climate adaptation strategies in Tenerife (Canary Islands): three pathways towards 2040, EUR 28786, 2017, doi:10.2760/587634.
- Hernandez, Y., Barbosa, P., Guimarães Pereira, Â., and Rivas, S., editor(s), Outcomes from the ‘Resilient Tenerife’ Workshop: a proposal for action, Publications Office of the European Union, Luxembourg, 2018a, JRC112461, doi:10.2760/615063.
- Hernandez, Y., Guimarães Pereira, Â. and P. Barbosa, ‘Resilient futures of a small island: A participatory approach in Tenerife (Canary Islands) to address climate change’, Environmental Science & Policy, 80, 28-37, 2018b.
- López-Solano, J., Redondas, A., Carlund, T., Rodríguez-Franco, J. J., Diémoz, H., León-Luis, S. F., Hernández-Cruz, B., Guirado-Fuentes, C., Kouremeti, N., Gröbner, J., Kazadzis, S., Carreño, V., Berjón, A., Santana-Díaz, D., Rodríguez-Valido, M., De Bock, V., Moreta, J. R., Rimmer, J., Smedley, A.R.D., Boulkelia, L., Jepsen, N., Eriksen, P., Bais, A. F., Shirovov, V., Vilaplana, J. M., Wilson, K. M., and Karppinen, T. UV Aerosol Optical Depth in the European Brewer Network. 9th International Workshop on Sand/Dust storms and Associated Dustfall, La Laguna, Tenerife, Spain, 22-24 May 2018a.
- López-Solano, J., Rodríguez, S., Pérez García-Pando, C., Sosa, E., García, M. I., Bustos, J.J., Marrero, C. and Alonso-Pérez, S. Northern African sources of mineral dust from measurements at the Izaña GAW Observatory. 9th International Workshop on Sand/Dust storms and Associated Dustfall, La Laguna, Tenerife, Spain, 22-24 May 2018b.
- Prats, N., González, P., Sanz, R., Extraordinary lightning episode during 12th and 13th of August 2015 in Canary region, was it the effect of dust aerosols? 9th International Workshop on Sand/Dust storms and Associated Dustfall, La Laguna, Tenerife, Spain, 22-24 May 2018.
- Raes, F., T. Bates, F. McGovern, and M. Van Liedekerke, The 2nd Aerosol Characterization Experiment (ACE-2): general overview and main results, Tellus, 52B, 141–168, 2000.
- Redondas, A. South Europe Regional Report: Armenia, Italy, Spain & Turkey. The 10th meeting of the Ozone Research Managers of the Parties to the Vienna Convention, Geneva, 28-30 March 2017.
- Rodríguez, S., Lucarelli, F., Nava, S., García, M.I., López-Solano, J., Marrero, C., Cuevas, E., Prats, N., High variability of dust composition in the Saharan Air Layer. 9th International Workshop on Sand/Dust storms and Associated Dustfall, La Laguna, Tenerife, Spain, 22-24 May 2018.
- Saviz Sehatkashani, Emilio Cuevas, Carmen Guirado-Fuentes, Mehdi Rashidzad, Gerardo Garcia-Castrillo, Abbas Ranjbar, Aerosol characterization using Calitoo hand-held sunphotometer at the District 22 of Tehran, 9th International Workshop on Sand/Duststorms and Associated Dustfall, La Laguna, Tenerife, Spain, 22-24 May 2018.
- Sosa, E., Rodríguez, S., García, M.I., López-Solano, Prats, N., Assessing the response of a TEOM dichotomous FDMS and BETA monitors to aerosol dust in the Saharan Air Layer. 9th International Workshop on Sand/Dust storms and Associated Dustfall, La Laguna, Tenerife, Spain, 22-24 May 2018.

23 Publications

23.1 List of peer-reviewed papers

2018

- Alonso-Blanco, E., Gómez-Moreno, F.J., Artíñano, B., Iglesias-Samitier, S., Juncal-Bello, V., Piñeiro-Iglesias, M., López-Mahía, P., Pérez, N., Brines, M., Alastuey, A., García, M.I., Rodríguez, S., Sorribas, M., Águila, A. del, Titos, G., Lyamani, H., Alados-Arboledas, L.: Temporal and spatial variability of atmospheric particle number size distributions across Spain, *Atmospheric Environment*, 1352-2310, <https://doi.org/10.1016/j.atmosenv.2018.06.046>, in press, 2018.
- Benedetti, A., Reid, J. S., Knippertz, P., Marsham, J. H., Di Giuseppe, F., Rémy, S., Basart, S., Boucher, O., Brooks, I. M., Menut, L., Mona, L., Laj, P., Pappalardo, G., Wiedensohler, A., Baklanov, A., Brooks, M., Colarco, P. R., Cuevas, E., da Silva, A., Escribano, J., Flemming, J., Huneeus, N., Jorba, O., Kazadzis, S., Kinne, S., Popp, T., Quinn, P. K., Sekiyama, T. T., Tanaka, T., and Terradellas, E.: Status and future of numerical atmospheric aerosol prediction with a focus on data requirements, *Atmos. Chem. Phys.*, 18, 10615-10643, <https://doi.org/10.5194/acp-18-10615-2018>, 2018.
- Berjón, A., Redondas, A., Sildoja, M.-M., Nevas, S., Wilson, K., León-Luis, S. F., el Gawhary, O., and Fountoulakis, I.: Sensitivity study of the instrumental temperature corrections on Brewer total ozone column measurements, *Atmos. Meas. Tech.*, 11, 3323-3337, <https://doi.org/10.5194/amt-11-3323-2018>, 2018.
- Borger, C., Schneider, M., Ertl, B., Hase, F., García, O. E., Sommer, M., Höpfner, M., Tjemkes, S. A., and Calbet, X.: Evaluation of MUSICA IASI tropospheric water vapour profiles using theoretical error assessments and comparisons to GRUAN Vaisala RS92 measurements, *Atmos. Meas. Tech.*, 11, 4981-5006, <https://doi.org/10.5194/amt-11-4981-2018>, 2018.
- Borsdorff, T., van de Brugh, J., Hu, H., Hasekamp, O., Sussmann, R., Rettinger, M., Hase, F., Gross, J., Schneider, M., Garcia, O., Stremme, W., Grutter, M., Feist, D. G., Arnold, S. G., De Mazière, M., Kumar Sha, M., Pollard, D. F., Kiel, M., Roehl, C., Wennberg, P. O., Toon, G. C., and Landgraf, J.: Mapping carbon monoxide pollution from space down to city scales with daily global coverage, *Atmos. Meas. Tech.*, 11, 5507-5518, <https://doi.org/10.5194/amt-11-5507-2018>, 2018.
- Che, H., Qi, B., Zhao, H., Xia, X., Eck, T. F., Goloub, P., Dubovik, O., Estelles, V., Cuevas-Agulló, E., Blarel, L., Wu, Y., Zhu, J., Du, R., Wang, Y., Wang, H., Gui, K., Yu, J., Zheng, Y., Sun, T., Chen, Q., Shi, G., and Zhang, X.: Aerosol optical properties and direct radiative forcing based on measurements from the China Aerosol Remote Sensing Network (CARSNET) in eastern China, *Atmos. Chem. Phys.*, 18, 405-425, <https://doi.org/10.5194/acp-18-405-2018>, 2018.
- Collaud Coen, M., Andrews, E., Aliaga, D., Andrade, M., Angelov, H., Bukowiecki, N., Ealo, M., Fialho, P., Flentje, H., Hallar, A. G., Hooda, R., Kalapov, I., Krejci, R., Lin, N.-H., Marinoni, A., Ming, J., Nguyen, N. A., Pandolfi, M., Pont, V., Ries, L., Rodríguez, S., Schauer, G., Sellegri, K., Sharma, S., Sun, J., Tunved, P., Velasquez, P., and Ruffieux, D.: Identification of topographic features influencing aerosol observations at high altitude stations, *Atmos. Chem. Phys.*, 18, 12289-12313, <https://doi.org/10.5194/acp-18-12289-2018>, 2018.
- Cuevas, E., Romero-Campos, P. M., Kouremeti, N., Kazadzis, S., García, R. D., Barreto, A., Guirado-Fuentes, C., Ramos, R., Toledano, C., Almansa, F., and Gröbner, J.: Aerosol Optical Depth comparison between GAW-PFR and AERONET-Cimel radiometers from long term (2005–2015) 1-minute synchronous measurements, *Atmos. Meas. Tech. Discuss.*, <https://doi.org/10.5194/amt-2018-438>, 2018.
- Driemel, A., Augustine, J., Behrens, K., Colle, S., Cox, C., Cuevas-Agulló, E., Denn, F. M., Duprat, T., Fukuda, M., Grobe, H., Haeffelin, M., Hodges, G., Hyett, N., Ijima, O., Kallis, A., Knap, W., Kustov, V., Long, C. N., Longenecker, D., Lupi, A., Maturilli, M., Mimouni, M., Ntsangwane, L., Ogihara, H., Olano, X., Olfes, M., Omori, M., Passamani, L., Pereira, E. B., Schmithüsen, H., Schumacher, S., Sieger, R., Tamlyn, J., Vogt, R., Vuilleumier, L., Xia, X., Ohmura, A., and König-Langlo, G.: Baseline Surface Radiation Network (BSRN): structure and data description (1992–2017), *Earth Syst. Sci. Data*, 10, 1491-1501, <https://doi.org/10.5194/essd-10-1491-2018>, 2018.
- Frey, M., Sha, M. K., Hase, F., Kiel, M., Blumenstock, T., Harig, R., Surawicz, G., Deutscher, N. M., Shiomi, K., Franklin, J., Bösch, H., Chen, J., Grutter, M., Ohyama, H., Sun, Y., Butz, A., Mengistu Tsidu, G., Ene, D., Wunch, D., Cao, Z., Garcia, O., Ramonet, M., Vogel, F., and Orphal, J.: Building the Collaborative Carbon Column Observing Network (COCCON): Long term stability and ensemble performance of the EM27/SUN Fourier transform spectrometer, *Atmos. Meas. Tech. Discuss.*, <https://doi.org/10.5194/amt-2018-146>, in review, 2018.
- García, R. D., Barreto, A., Cuevas, E., Gröbner, J., García, O. E., Gómez-Peláez, A., Romero-Campos, P. M., Redondas, A., Cachorro, V. E., and Ramos, R.: Comparison of observed and modeled cloud-free longwave downward radiation (2010–2016) at the high mountain BSRN Izaña station, *Geosci. Model Dev.*, 11, 2139-2152, <https://doi.org/10.5194/gmd-11-2139-2018>, 2018.
- García, R. D., Cuevas, E., Ramos, R., Cachorro, V. E., Redondas, A., and Moreno-Ruiz, J. A.: Description of the Baseline Surface Radiation Network (BSRN) station at the Izaña Observatory (2009–2017): measurements and quality control/assurance procedures, *Geosci. Instrum. Method. Data Syst. Discuss.*, <https://doi.org/10.5194/gi-2018-41>, 2018.
- García, O. E., Schneider, M., Ertl, B., Sepúlveda, E., Borger, C., Diekmann, C., Wiegeler, A., Hase, F., Barthlott, S., Blumenstock, T., Raffälski, U., Gómez-Peláez, A., Steinbacher, M., Ries, L., and de Frutos, A. M.: The MUSICA IASI CH₄ and N₂O products and their comparison to HIPPO, GAW and NDACC FTIR references, *Atmos. Meas. Tech.*, 11, 4171-4215, <https://doi.org/10.5194/amt-11-4171-2018>, 2018.
- Gaudel, A., O. R. Cooper, G. Ancellet, B. Barret, A. Boynard, J. P. Burrows, C. Clerbaux, P.-F. Coheur, J. Cuesta, E. Cuevas, S. Doniki, G. Dufour, F. Ebojje, G. Foret, O. Garcia, M. J. Granados-Muñoz, J. W. Hannigan, F. Hase, B. Hassler, G. Huang, D. Hurtmans, D. Jaffe, N. Jones, P. Kalabokas, B. Kerridge, S. Kulawik, B. Latter, T. Leblanc, E. Le Flochmoën, W. Lin, J. Liu, X. Liu, E. Mahieu, A. McClure-Begley, J. L. Neu, M. Osman, M. Palm, H. Petetin, I. Petropavlovskikh, R. Querel, N. Rapp, A. Rozanov, M. G. Schultz, J. Schwab, R. Siddans, D. Smale, M. Steinbacher, H. Tanimoto, D. W. Tarasick, V. Thouret, A. M. Thompson, T. Trickl, E. Weatherhead, C. Wespes, H. M. Worden, C. Vigouroux, X. Xu, G. Zeng, J. Ziemke: The Tropospheric Ozone Assessment Report: Present-day distribution and trends of tropospheric ozone relevant to climate and global atmospheric chemistry

- model evaluation, *Elem Sci Anth*, 6: 39. DOI: <https://doi.org/10.1525/elementa.291>, 2018.
- Kazadzis, S., Kouremeti, N., Diémoz, H., Gröbner, J., Forgan, B. W., Campanelli, M., Estellés, V., Lantz, K., Michalsky, J., Carlund, T., Cuevas, E., Toledano, C., Becker, R., Nyeki, S., Kosmopoulos, P. G., Tatsiankou, V., Vuilleumier, L., Denn, F. M., Ohkawara, N., Ijima, O., Goloub, P., Raptis, P. I., Milner, M., Behrens, K., Barreto, A., Martucci, G., Hall, E., Wendell, J., Fabbri, B. E., and Wehrli, C.: Results from the Fourth WMO Filter Radiometer Comparison for aerosol optical depth measurements, *Atmos. Chem. Phys.*, 18, 3185-3201, <https://doi.org/10.5194/acp-18-3185-2018>, 2018.
- Köhler, U., Nevas, S., McConville, G., Evans, R., Smid, M., Stanek, M., Redondas, A., and Schönenborn, F.: Optical characterisation of three reference Dobsons in the ATMOZ Project – verification of G. M. B. Dobson's original specifications, *Atmos. Meas. Tech.*, 11, 1989-1999, <https://doi.org/10.5194/amt-11-1989-2018>, 2018.
- Lakkala, K., Redondas, A., Meinander, O., Thölix, L., Hamari, B., Almansa, A. F., Carreno, V., García, R. D., Torres, C., Deferrari, G., Ochoa, H., Bernhard, G., Sanchez, R., and de Leeuw, G.: UV measurements at Marambio and Ushuaia during 2000–2010, *Atmos. Chem. Phys.*, 18, 16019-16031, <https://doi.org/10.5194/acp-18-16019-2018>, 2018.
- López-Solano, J., Redondas, A., Carlund, T., Rodríguez-Franco, J. J., Diémoz, H., León-Luis, S. F., Hernández-Cruz, B., Guirado-Fuentes, C., Kouremeti, N., Gröbner, J., Kazadzis, S., Carreño, V., Berjón, A., Santana-Díaz, D., Rodríguez-Valido, M., De Bock, V., Moreta, J. R., Rimmer, J., Smedley, A.R.D., Boulkelia, L., Jepsen, N., Eriksen, P., Bais, A. F., Shirov, V., Vilaplana, J. M., Wilson, K. M., and Karppinen, T.: Aerosol optical depth in the European Brewer Network, *Atmos. Chem. Phys.*, <https://doi.org/10.5194/acp-18-3885-2018>, 2018.
- O'Dell, C. W., Eldering, A., Wennberg, P. O., Crisp, D., Gunson, M. R., Fisher, B., Frankenberg, C., Kiel, M., Lindqvist, H., Mandrake, L., Merrelli, A., Natraj, V., Nelson, R. R., Osterman, G. B., Payne, V. H., Taylor, T. E., Wunch, D., Drouin, B. J., Oyafuso, F., Chang, A., McDuffie, J., Smyth, M., Baker, D. F., Basu, S., Chevallier, F., Crowell, S. M. R., Feng, L., Palmer, P. I., Dubey, M., García, O. E., Griffith, D. W. T., Hase, F., Iraci, L. T., Kivi, R., Morino, I., Notholt, J., Ohyama, H., Petri, C., Roehl, C. M., Sha, M. K., Strong, K., Sussmann, R., Te, Y., Uchino, O., and Velazco, V. A.: Improved retrievals of carbon dioxide from Orbiting Carbon Observatory-2 with the version 8 ACOS algorithm, *Atmos. Meas. Tech.*, 11, 6539-6576, <https://doi.org/10.5194/amt-11-6539-2018>, 2018.
- Pandolfi, M., Alados-Arboledas, L., Alastuey, A., Andrade, M., Angelov, C., Artiñano, B., Backman, J., Baltensperger, U., Bonasoni, P., Bukowiecki, N., Collaud Coen, M., Conil, S., Coz, E., Crenn, V., Dudoitis, V., Ealo, M., Eleftheriadis, K., Favez, O., Fetfatzis, P., Fiebig, M., Flentje, H., Ginot, P., Gysel, M., Henzing, B., Hoffer, A., Holubova Smejkalova, A., Kalapov, I., Kalivitis, N., Kouvarakis, G., Kristensson, A., Kulmala, M., Lihavainen, H., Lunder, C., Luoma, K., Lyamani, H., Marinoni, A., Mihalopoulos, N., Moerman, M., Nicolas, J., O'Dowd, C., Petäjä, T., Petit, J.-E., Pichon, J. M., Prokopciuk, N., Putaud, J.-P., Rodríguez, S., Sciare, J., Sellegri, K., Swietlicki, E., Titos, G., Tuch, T., Tunved, P., Ulevicius, V., Vaishya, A., Vana, M., Virkkula, A., Vratolis, S., Weingartner, E., Wiedensohler, A., and Laj, P. A.: European aerosol phenomenology – 6: scattering properties of atmospheric aerosol particles from 28 ACTRIS sites, *Atmos. Chem. Phys.*, 18, 7877-7911, <https://doi.org/10.5194/acp-18-7877-2018>, 2018.
- Redondas, A., Nevas, S., Berjón, A., Sildoja, M.-M., León-Luis, S. F., Carreño, V., and Santana-Díaz, D.: Wavelength calibration of Brewer spectrophotometer using a tunable pulsed laser and implications to the Brewer ozone retrieval, *Atmos. Meas. Tech.*, 11, 3759-3768, <https://doi.org/10.5194/amt-11-3759-2018>, 2018.
- Rimmer, J. S., Redondas, A., and Karppinen, T.: EuBrewNet – A European Brewer network (COST Action ES1207), an overview., *Atmos. Chem. Phys.*, 18, 10347-10353, <https://doi.org/10.5194/acp-18-10347-2018>, 2018.
- Tobías, A., Rivas, I., Reche, C., Alastuey, A., Rodríguez, S., Fernández-Camacho, R., Sánchez de la Campa, A.M., de la Rosa, J., Sunyer, J., Querol, X.: Short-term effects of ultrafine particles on daily mortality by primary vehicle exhaust versus secondary origin in three Spanish cities., *Environ. Int.* 111, 144–151, <https://doi.org/10.1016/j.envint.2017.11.015>, 2018.
- Toledano, C., González, R., Fuertes, D., Cuevas, E., Eck, T. F., Kazadzis, S., Kouremeti, N., Gröbner, J., Goloub, P., Blarel, L., Román, R., Barreto, A., Berjón, A., Holben, B. N., and Cachorro, V. E.: Assessment of Sun photometer Langley calibration at the high-elevation sites Mauna Loa and Izaña, *Atmos. Chem. Phys.*, 18, 14555-14567, <https://doi.org/10.5194/acp-18-14555-2018>, 2018.
- Vigouroux, C., Bauer Aquino, C. A., Bauwens, M., Becker, C., Blumenstock, T., De Mazière, M., García, O., Grutter, M., Guarín, C., Hannigan, J., Hase, F., Jones, N., Kivi, R., Koshelev, D., Langerock, B., Lutsch, E., Makarova, M., Metzger, J.-M., Müller, J.-F., Notholt, J., Ortega, I., Palm, M., Paton-Walsh, C., Poberovskii, A., Rettinger, M., Robinson, J., Smale, D., Stavrakou, T., Stremme, W., Strong, K., Sussmann, R., Té, Y., and Toon, G.: DACC harmonized formaldehyde time-series from 21 FTIR stations covering a wide range of column abundances, *Atmos. Meas. Tech.*, 11, 5049-5073, <https://doi.org/10.5194/amt-11-5049-2018>, 2018.
- Yuan, Y., Ries, L., Petermeier, H., Steinbacher, M., Gómez-Peláez, A. J., Leuenberger, M. C., Schumacher, M., Trickl, T., Couret, C., Meinhardt, F., and Menzel, A.: Adaptive selection of diurnal minimum variation: a statistical strategy to obtain representative atmospheric CO₂ data and its application to European elevated mountain stations, *Atmos. Meas. Tech.*, 11, 1501-1514, <https://doi.org/10.5194/amt-11-1501-2018>, 2018.

2017

- Almansa, A. F., Cuevas, E., Torres, B., Barreto, A., García, R. D., Cachorro, V. E., de Frutos, A. M., López, C., and Ramos, R.: A new zenith-looking narrow-band radiometer-based system (ZEN) for dust aerosol optical depth monitoring, *Atmos. Meas. Tech.*, 10, 565-579, doi:10.5194/amt-10-565-2017, 2017.
- Azorin-Molina, C., Menendez, M., McVicar, T.R., Acevedo, A., Vicente-Serrano, S.M., Cuevas, E., Minola, L., Chen, D.: Wind speed variability over the Canary Islands, 1948–2014: focusing on trend differences at the land–ocean interface and below–above the trade-wind inversion layer, *Clim. Dyn.*, DOI 10.1007/s00382-017-3861-0, 2017.
- Bader, W., Bovy, B., Conway, S., Strong, K., Smale, D., Turner, A. J., Blumenstock, T., Boone, C., Collaud Coen, M., Coulon, A., García, O., Griffith, D. W. T., Hase, F., Hausmann, P., Jones, N., Krummel, P., Murata, I., Morino, I., Nakajima, H., O'Doherty, S., Paton-Walsh, C., Robinson, J., Sandrin, R., Schneider, M., Servais, C., Sussmann, R., and Mahieu, E.: The recent increase of atmospheric methane from 10 years of ground-based NDACC FTIR observations since 2005, *Atmos. Chem. Phys.*, 17, 2255-2277, doi:10.5194/acp-17-2255-2017, 2017.

- Barreto, Á., Román, R., Cuevas, E., Berjón, A. J., Almansa, A. F., Toledano, C., González, R., Hernández, Y., Blarel, L., Goloub, P., Guirado, C., and Yela, M.: Assessment of nocturnal aerosol optical depth from lunar photometry at the Izaña high mountain observatory, *Atmos. Meas. Tech.*, 10, 3007-3019, <https://doi.org/10.5194/amt-10-3007-2017>, 2017.
- Barthlott, S., Schneider, M., Hase, F., Blumenstock, T., Kiel, M., Dubravica, D., García, O. E., Sepúlveda, E., Mengistu Tsidu, G., Takele Kenea, S., Grutter, M., Plaza-Medina, E. F., Stremme, W., Strong, K., Weaver, D., Palm, M., Warneke, T., Notholt, J., Mahieu, E., Servais, C., Jones, N., Griffith, D. W. T., Smale, D., and Robinson, J.: Tropospheric water vapour isotopologue data (H216O, H218O, and HD16O) as obtained from NDACC/FTIR solar absorption spectra, *Earth Syst. Sci. Data*, 9, 15-29, doi:10.5194/essd-9-15-2017, 2017.
- Castillo, S., A. Alastuey, E. Cuevas, X. Querol, A. Avila: Quantifying Dry and Wet Deposition Fluxes in Two Regions of Contrasting African Influence: The NE Iberian Peninsula and the Canary Islands, *Atmosphere* 2017, 8, 5, 86; doi:10.3390/atmos8050086, 2017.
- Córdoba-Jabonero, C., F.J.S. Lopes, E. Landulfo, E. Cuevas, H. Ochoa, and M. Gil-Ojeda: Diversity on subtropical and polar cirrus clouds properties as derived from both ground-based lidars and CALIPSO/CALIOP measurements, *Atmos. Res.*, 183, 151-165, <http://dx.doi.org/10.1016/j.atmosres.2016.08.0155>, 2017.
- Cuevas, E., A.J. Gómez-Peláez, S. Rodríguez, E. Terradellas, S. Basart, R.D. García, O.E. García, S. Alonso-Pérez: The pulsating nature of large-scale Saharan dust transport as a result of interplays between mid-latitude Rossby waves and the North African Dipole Intensity, *Atmospheric Environment*, 167, 586-602, ISSN 1352-2310, <https://doi.org/10.1016/j.atmosenv.2017.08.059>, 2017.
- De Linares, C., Delgado, R., Air, M.J., Alcázar, P., Alonso-Pérez, S., Boi, M., Cariñanos, P., Cuevas, E., Díaz de la Guardia, C., Elvira-Rendueles, B., Fernández-González, D., Galán, C., Montserrat Gutiérrez-Bustillo, A., Pérez-Badia, R., Rodríguez-Rajo, F.J., Ruíz-Valenzuela, L., Tormo-Molina, R., Trigo, M., Valencia-Barrera, R.M. Valle, A., Belmonte, J.: Changes in the Mediterranean pine forest: pollination patterns and annual trends of airborne pollen *Aerobiologia*, doi:10.1007/s10453-017-9476-4, 2017.
- Fountoulakis, I., Redondas, A., Lakkala, K., Berjon, A., Bais, A. F., Doppler, L., Feister, U., Heikkilä, A., Karppinen, T., Karhu, J. M., Koskela, T., Garane, K., Fragkos, K., and Savastiouk, V.: Temperature dependence of the Brewer global UV measurements, *Atmos. Meas. Tech.*, 10, 4491-4505, <https://doi.org/10.5194/amt-10-4491-2017>, 2017.
- García, M. I., Rodríguez, S., and Alastuey, A.: Impact of North America on the aerosol composition in the North Atlantic free troposphere, *Atmos. Chem. Phys.*, 17, 7387-7404, <https://doi.org/10.5194/acp-17-7387-2017>, 2017.
- García, R. D., Cuevas, E., García, O. E., Ramón, R., Romero-Campos, P. M., de Ory, F., Cachorro, V. E., and de Frutos, A.: Compatibility of different measurement techniques of global solar radiation and application for long-term observations at Izaña Observatory, *Atmos. Meas. Tech.*, 10, 731-743, doi:10.5194/amt-10-731-2017, 2017.
- García, O. E., Sepúlveda, E., Schneider, M., Wiegeler, A., Borger, C., Hase, F., Barthlott, S., Blumenstock, T., and de Frutos, Á. M.: Upper tropospheric CH₄ and N₂O retrievals from MetOp/IASI within the project MUSICA, *Atmos. Meas. Tech. Discuss.*, doi:10.5194/amt-2016-326, 2017.
- García, M. I., van Drooge, B. L., Rodríguez, S., and Alastuey, A.: Speciation of organic aerosols in the Saharan Air Layer and in the free troposphere westerlies, *Atmos. Chem. Phys.*, 17, 8939-8958, <https://doi.org/10.5194/acp-17-8939-2017>, 2017.
- Gomez-Pelaez, A. J., Ramos, R., Cuevas, E., Gomez-Trueba, V., and Reyes, E.: Atmospheric CO₂, CH₄, and CO with CRDS technique at the Izaña Global GAW station: instrumental tests, developments and first measurement results, *Atmos. Meas. Tech. Discuss.*, <https://doi.org/10.5194/amt-2017-375>, 2017.
- Huang, G., Liu, X., Chance, K., Yang, K., Bhartia, P. K., Cai, Z., Allaart, M., Ancellet, G., Calpini, B., Coetzee, G. J. R., Cuevas-Agulló, E., Cupeiro, M., De Backer, H., Dubey, M. K., Fuelberg, H. E., Fujiwara, M., Godin-Beekmann, S., Hall, T. J., Johnson, B., Joseph, E., Kivi, R., Kois, B., Komala, N., König-Langlo, G., Laneve, G., Leblanc, T., Marchand, M., Minschwaner, K. R., Morris, G., Newchurch, M. J., Ogino, S.-Y., Ohkawara, N., PETERS, A. J. M., Posny, F., Querel, R., Scheele, R., Schmidlin, F. J., Schnell, R. C., Schrems, O., Selkirk, H., Shiotani, M., Skrivánková, P., Stübi, R., Taha, G., Tarasick, D. W., Thompson, A. M., Thouret, V., Tully, M. B., Van Malderen, R., Vömel, H., von der Gathen, P., Witte, J. C., and Yela, M.: Validation of 10-year SAO OMI Ozone Profile (PROFOZ) product using ozonesonde observations, *Atmos. Meas. Tech.*, 10, 2455-2475, <https://doi.org/10.5194/amt-10-2455-2017>, 2017.
- Kazadzis, S., Kouremeti, N., Diémoz, H., Gröbner, J., Forgan, B. W., Campanelli, M., Estellés, V., Lantz, K., Michalsky, J., Carlund, T., Cuevas, E., Toledano, C., Becker, R., Nyeki, S., Kosmopoulos, P. G., Tatsiankou, V., Vuilleumier, L., Denn, F. M., Ohkawara, N., Ijima, O., Goloub, P., Raptis, P. I., Milner, M., Behrens, K., Barreto, A., Martucci, G., Hall, E., Wendell, J., Fabbri, B. E., and Wehrli, C.: Results from the 4th WMO Filter Radiometer Comparison for aerosol optical depth measurements, *Atmos. Chem. Phys. Discuss.*, <https://doi.org/10.5194/acp-2017-1105>, in review, 2017.
- Móring, A., Vieno, M., Doherty, R. M., Milford, C., Nemitz, E., Twigg, M. M., Horváth, L., and Sutton, M. A.: Process-based modelling of NH₃ exchange with grazed grasslands, *Biogeosciences*, 14, 4161-4193, <https://doi.org/10.5194/bg-14-4161-2017>, 2017.
- Román, R., B. Torres, D. Fuertes, V.E. Cachorro, O. Dubovik, C. Toledano, A. Cazorla, A. Barreto, J.L. Bosch, T. Lapyonok, R. González, P. Goloub, M.R. Perrone, F.J. Olmo, A. de Frutos, L. Alados-Arboledas: Remote sensing of lunar aureole with a sky camera: Adding information in the nocturnal retrieval of aerosol properties with GRASP code, *Remote Sensing of Environment*, 196, 238-252, <https://doi.org/10.1016/j.rse.2017.05.013>, 2017.
- Schneider, M., Borger, C., Wiegeler, A., Hase, F., García, O. E., Sepúlveda, E., and Werner, M.: MUSICA MetOp/IASI {H₂O, δD} pair retrieval simulations for validating tropospheric moisture pathways in atmospheric models, *Atmos. Meas. Tech.*, 10, 507-525, doi:10.5194/amt-10-507-2017, 2017.
- Schultz, M. G., Schröder, S., Lyapina, O., Cooper, O. R., Galbally, I., Petropavlovskikh, I., von Schneidmesser, E., Tanimoto, H., Elshorbany, Y., Naja, M., Seguel, R. J., Dauert, U., Eckhardt, P., Feigenspan, S., Fiebig, M., Hjellbrekke, A.-G., Hong, Y.-D., Kjeld, P. Ch., Koide, H., Lear, G., Tarasick, D., Ueno, M., Wallasch, M., Baumgardner, D., Chuang, M.-T., Gillett, R., Lee, M., Molloy, S., Moolla, R., Wang, T., Sharps, K., Adame, J.A., Ancellet, G., Apadula, F., Artaxo, P., Barlasina, M.E., Bogucka, M., Bonasoni, P., Chang, L., Colomb, A., Cuevas-Agulló, E., Cupeiro, M., Degorska, A., Ding, A., Fröhlich, M., Frolova, M., Gadhavi, H., Gheusi, F., Gilge, S., Gonzalez, M.Y., Gros, V., Hamad, S.H. Helmig, D., Henriques, D.,

- Hermansen, O., Holla, R., Hueber, J., Im, U., Jaffe, D.A.; Komala, N., Kubistin, D., Lam, K.-S., Laurila, T., Lee, H., Levy, I., Mazzoleni, C., Mazzoleni, L., McClure-Begley, A., Mohamad, M., Murovec, M., Navarro-Comas, M., Nicodim, F., Parrish, D., Read, K.A., Reid, N., Ries, L., Saxena, P., Schwab, J.J., Scorgie, Y., Senik, I., Simmonds, P., Sinha, V., Skorokhod, A.I., Spain, G., Spangl, W., Spoor, R., Springston, S.R., Steer, K., Steinbacher, M., Suharguniyawan, E., Torre, P., Trickl, T., Weili, L., Weller, R., Xu, X., Xue, L., Zhiqiang, M.: : Tropospheric Ozone Assessment Report, links to Global surface ozone datasetsx. PANGAEA, <https://doi.org/10.1594/PANGAEA.876108>, Supplement to: Schultz, MG et al. (2017): Tropospheric Ozone Assessment Report: Database and Metrics Data of Global Surface Ozone Observations, *Elementa - Science of the Anthropocene*, 5:58, 26 pp, <https://doi.org/10.1525/elementa.244>, 2017.
- Shirai, T., M. Ishizawa, R. Zhuravlev, A. Ganshin, D. Belikov, M. Saito, T. Oda, V. Valsala, A.J. Gomez-Pelaez, R. Langenfelds, and S. Maksyutov; A decadal inversion of CO₂ using the Global Eulerian–Lagrangian Coupled Atmospheric model (GELCA): sensitivity to the ground-based observation network, *Tellus B: Chemical and Physical Meteorology*, Vol. 69 , Iss. 1, 2017.
- Steinbrecht, W., Froidevaux, L., Fuller, R., Wang, R., Anderson, J., Roth, C., Bourassa, A., Degenstein, D., Damadeo, R., Zawodny, J., Frith, S., McPeters, R., Bhartia, P., Wild, J., Long, C., Davis, S., Rosenlof, K., Sofieva, V., Walker, K., Raupoe, N., Rozanov, A., Weber, M., Laeng, A., von Clarmann, T., Stiller, G., Kramarova, N., Godin-Beekmann, S., Leblanc, T., Querel, R., Swart, D., Boyd, I., Hocke, K., Kämpfer, N., Maillard Barras, E., Moreira, L., Nedoluha, G., Vigouroux, C., Blumenstock, T., Schneider, M., García, O., Jones, N., Mahieu, E., Smale, D., Kotkamp, M., Robinson, J., Petropavlovskikh, I., Harris, N., Hassler, B., Hubert, D., and Tummon, F.: An update on ozone profile trends for the period 2000 to 2016, *Atmos. Chem. Phys.*, 17, 10675-10690, <https://doi.org/10.5194/acp-17-10675-2017>, 2017.
- Torres, B., Dubovik, O., Fuertes, D., Schuster, G., Cachorro, V. E., Lapiónok, T., Goloub, P., Blarel, L., Barreto, A., Mallet, M., Toledano, C., and Tanré, D.: Advanced characterization of aerosol properties from measurements of spectral optical depth using the GRASP algorithm . *Atmos. Meas. Tech.*, 10, 3743-3781. <https://www.atmos-meas-tech.net/10/3743/2017/>, 2017.
- Tsuruta, A., Aalto, T., Backman, L., Hakkarainen, J., van der Laan-Luijkx, I. T., Krol, M. C., Spahni, R., Houweling, S., Laine, M., Dlugokencky, E., Gomez-Pelaez, A. J., van der Schoot, M., Langenfelds, R., Ellul, R., Arduini, J., Apadula, F., Gerbig, C., Feist, D. G., Kivi, R., Yoshida, Y., and Peters, W.: Global methane emission estimates for 2000–2012 from CarbonTracker Europe-CH4 v1.0, *Geosci. Model Dev.*, 10, 1261-1289, doi:10.5194/gmd-10-1261-2017, 2017.
- Wunch, D., Wennberg, P. O., Osterman, G., Fisher, B., Naylor, B., Roehl, C. M., O'Dell, C., Mandrake, L., Viatte, C., Kiel, M., Griffith, D. W. T., Deutscher, N. M., Velasco, V. A., Notholt, J., Warneke, T., Petri, C., De Maziere, M., Sha, M. K., Sussmann, R., Rettinger, M., Pollard, D., Robinson, J., Morino, I., Uchino, O., Hase, F., Blumenstock, T., Feist, D. G., Arnold, S. G., Strong, K., Mendonca, J., Kivi, R., Heikkinen, P., Iraci, L., Podolske, J., Hillyard, P. W., Kawakami, S., Dubey, M. K., Parker, H. A., Sepulveda, E., García, O. E., Te, Y., Jeseck, P., Gunson, M. R., Crisp, D., and Eldering, A.: Comparisons of the Orbiting Carbon Observatory-2 (OCO-2) XCO₂ measurements with TCCON, *Atmos. Meas. Tech.*, 10, 2209-2238, <https://doi.org/10.5194/amt-10-2209-2017>, 2017.
- Yela, M., Gil-Ojeda, M., Navarro-Comas, M., González-Bartolomé, D., Puentedura, O., Funke, B., Iglesias, J., Rodríguez, S., García, O., Ochoa, H., and Deferrari, G.: Hemispheric asymmetry in stratospheric NO₂ trends, *Atmos. Chem. Phys.*, 17, 13373-13389, <https://doi.org/10.5194/acp-17-13373-2017>, 2017.
- Yuan, Y., Ries, L., Petermeier, H., Steinbacher, M., Gómez-Peláez, A. J., Leuenberger, M. C., Schumacher, M., Trickl, T., Couret, C., Meinhardt, F., and Menzel, A.: Adaptive Baseline Finder, a statistical data selection strategy to identify atmospheric CO₂ baseline levels and its application to European elevated mountain stations, *Atmos. Meas. Tech. Discuss.*, <https://doi.org/10.5194/amt-2017-316>, in review, 2017.
- Zerefos, C. S., Eleftheratos, K., Kapsomenakis, J., Solomos, S., Inness, A., Balis, D., Redondas, A., Eskes, H., Allaart, M., Amiridis, V., Dahlback, A., De Bock, V., Diémoz, H., Engelmann, R., Eriksen, P., Fioletov, V., Gröbner, J., Heikkilä, A., Petropavlovskikh, I., Jaroslowski, J., Josefsson, W., Karppinen, T., Köhler, U., Meleti, C., Repapis, C., Rimmer, J., Savijyh, V., Shirov, V., Siani, A. M., Smedley, A. R. D., Stanek, M., and Stübi, R.: Detecting volcanic sulfur dioxide plumes in the Northern Hemisphere using the Brewer spectrophotometers, other networks, and satellite observations, *Atmos. Chem. Phys.*, 17, 551-574, doi:10.5194/acp-17-551-2017, 2017.

23.2 Conference Presentations/Posters

2018

- Almansa, A.F., Cuevas, E., Barreto, A., Torres, B. and López-Solano, C. Dust aerosol optical depth (DOD) monitoring with a ZEN-R52 radiometer: An upgraded version of ZEN-R41 prototype. 9th International Workshop on Sand/Dust storms and Associated Dustfall, La Laguna, Tenerife, Spain, 22-24 May 2018.
- Azorín-Molina, M. Menéndez, T. R. McVicar, A. Acevedo, S.o M. Vicente-Serrano, E. Cuevas, L. Minola, G. Zhang, A. Chen, D. Chen, Tendencias de la Velocidad del Viento en Canarias 1948-2014, XI Congreso Internacional de la Asociación Española de Climatología (AEC): El Clima: aire, agua, tierra y fuego, Publicaciones de la Asociación Española de Climatología (AEC), 2018, Serie A. Murcia, 1098 pp. ISBN: 978-84-7837-098-6 NIPO (usb): 014-18-008-4; Depósito Legal (usb): M-31443-2018, Cartagena, October 17-19, 2018.
- Barreto, A., E. Cuevas, J. Carrillo, A. Berjón, C. Guirado-Fuentes, Y. Hernández, J. C. Guerra and M. Yela, Saharan Air Layer profiling at the Canary Islands using MPL and radiosondes, 9th International Workshop on Sand/Duststorms and Associated Dustfall, Tenerife (Spain), 22-24 May 2018.
- Basart, S., García-Castrillo, G., Cuevas, E., Goloub, P., Cazorla, A., Alastuey, A., Mortier, A., Benedetti, A. and Terradellas, E. Towards continuous evaluation of dust profiles in the WMO SDS-WAS. 9th International Workshop on Sand/Dust storms and Associated Dustfall, La Laguna, Tenerife, Spain, 22-24 May 2018.
- Berjón, A., A. Barreto, Y. Hernández, E. Cuevas, M. Yela. Lidar signal analysis using AOD at two heights. 9th International Workshop on Sand/Duststorms and Associated Dustfall, Tenerife (Spain), 22-24 May 2018.
- Borsdorff, Tobias, Joost aan de Brugh, Haili Hu, Otto Hasekamp, Ralf Sussmann, Markus Rettinger, Frank Hase, Jochen Gross, Matthias Schneider, Omaira E. Garcia, Wolfgang Stremme,

- Michel Grutter, Dietrich G. Feist, Martine De Maziere, Mahesh Kumar Sha, David F. Pollard, Matthaeus Kiel, Geoffrey C. Toon, Paul O. Wennberg, and Jochen Landgraf, First carbon monoxide retrieval from TROPOMI's shortwave infrared radiance measurements, European Geosciences Union General Assembly 2018, Vienna (Austria), 8–13 April 2018.
- Cachorro, Victoria; Mateos, David; Toledano, Carlos; Velasco-Merino, Cristian; González, Ramiro; Berjón, Alberto; Guirado, Carmen; Román, Roberto; Antuña, Juan Carlos; Herreras, Marcos; Calle, Abel; de Frutos, Ángel Máximo; Observación atmosférica en zonas polares llevada a cabo por el grupo GOA-Uva, IX Simposio Español de Estudios Polares, Madrid (Spain), 5-7 September 2018.
- Cuevas, E., J.J. Bustos, S. Rodríguez, C. Marrero, E. Reyes, R.D. García, O.E. García, A. Barreto, and C. Guirado, Short-term variations of the Saharan Air Layer atmospheric properties over the North Atlantic driven by NAFDI: Summer 2017 case analysis, 9th International Workshop on Sand/Duststorms and Associated Dustfall, Tenerife (Spain), 22-24 May, 2018.
- Cuevas, E., Izaña “super-site”, Expert Meeting on Atmospheric Composition Fiducial Reference Measurements at EUMETSAT HQ, Darmstadt, Germany, 22-23 February 2018.
- Cuevas, E. Cambio Climático en las Cumbres de Tenerife, I Jornadas de Investigación y Divulgación: Conservación del Matorral de Alta Montaña, Centro de Visitante Telesforo Bravo, La Orotava, Tenerife, April 11-12, 2018.
- Cuevas, E., Izaña “super-site”, EUMETSAT-AEMET Activity Meeting, June 14th, 2018.
- Cuevas, E., A. Barreto, R. Ramos, R. García, F. Almansa, A. J. Berjón and C. Guirado, Last activities and results of the WMO-CIMO Testbed for Aerosols and Water Vapor Remote Sensing Instruments (Izaña, Spain), WMO CIMO TECO 2018, Amsterdam, 8-11 October 2018.
- García, R.D., A. Barreto, E. Cuevas, J. Gröbner, O.E. García, A. Gómez-Peláez, P.M. Romero-Campos, A. Redondas, V.E. Cachorro and R. Ramos, Comparison of observed and modeled cloud-free longwave downward radiation (2010-2016) at the high mountain BSRN Izaña station, 15th BSRN Scientific Review and Workshop at CIRES, Boulder CO, USA July, 16-20, 2018.
- De La Rosa, J.D., Rodríguez, S., García-Álvarez, M.I., Sosa, E., Salvador, A., Sánchez De La Campa, A. M., Márquez, G., Rodríguez-Aller, J. and Gil-Ibarguchi, J.I. Sr-Nd isotope composition of Saharan dust observed in the North Atlantic free troposphere. 9th International Workshop on Sand/Dust storms and Associated Dustfall, La Laguna, Tenerife, Spain, 22-24 May 2018.
- García ,R.D., E. Cuevas , R. Ramos , V.E. Cachorro, and A. Redondas, Status of the Izaña BSRN station in July 2018, 15th BSRN Scientific Review and Workshop at CIRES, Boulder CO, USA July, 16-20, 2018.
- García, R.D., O.E. García, E. Cuevas and J.J. Bustos, Long-term aerosol optical depth (1941-2017) at the Izaña Observatory, 9th International Workshop on Sand/Duststorms and Associated Dustfall at Tenerife, Spain, 22-24 May 2018.
- García, O.E., M. Schneider, B. Ertl, F. Hase, C. Borger, E. Sepúlveda, T. Blumenstock, Uwe Raffälski and A.J. Gómez-Peláez, IASI for Surveying Methane and Nitrous Oxide in the Troposphere: MUSICA products and its validation, 14th International Workshop on Greenhouse Gas Measurements from Space (IWGGMS-14), Toronto (Canada), 8-10 May, 2018.
- García, O.E., E. Sepúlveda, E. Cuevas, A.J. Gómez-Peláez, M. Schneider, F. Hase. T. Blumenstock, A. Redondas, and V. Carreño, Long-term Monitoring of Greenhouse Gases at the Izaña Atmospheric Observatory, 14th International Workshop on Greenhouse Gas Measurements from Space (IWGGMS-14), Toronto (Canada), 8-10 May, 2018.
- García, O.E., E. Sepúlveda, J.-A. Morgui, C. Estruch, R. Curcoll, M. Frey, C. Schneider, R. Ramos, C. Torres, S. León, F. Hase, A. Butz, C. Toledano, E. Cuevas, T. Blumenstock, C. Pérez, M. Guevara, J. J. Bustos, and V. Carreño, MEGEI-MAD: Monitoring of Greenhouse Gases Concentrations in Madrid, Integrated Global Greenhouse Gas Information System (IG3IS) Symposium, 13 – 15 November, WMO, Geneva, Switzerland, 2018.
- Guirado-Fuentes, C., Y. Hernández, E. Cuevas, Validation of Calitoo hand-held sun photometer for aerosol characterization under background and dust conditions, 9th International Workshop on Sand/Duststorms and Associated Dustfall, Tenerife (Spain), 22-24 May 2018.
- Hase, F., M. Frey, D. Dubravica, J. Groß, T. Blumenstock, Q. Tu, J. Orphal, A. Dehn, P. Castracane, A. Butz, R. Kleinschek, A. Luther, J. Chen, R. Harig, G. Surawicz, W.R. Simpson, N. Jacobs, M. Grutter, W. Stremme, N. Jones, D. W. Griffith, G. Mengistu Tsidu, K. Shiomi, I Morino, S. Wofsy, O. Garcia, D. Pollard, M. Dubey, D. Wunch, P.O. Wennberg, M.K. Sha, H. Gadhavi, D. Ene, M. Ramonet, Y. Sun, H. Boesch, COCCON - a framework for operating the EM27/SUN spectrometer, 14th International Workshop on Greenhouse Gas Measurements from Space (IWGGMS-14), Toronto (Canada), 8-10 May, 2018.
- Hase, F., M. Frey, D. Dubravica, J. Groß, T. Blumenstock, Q. Tu, J. Orphal, A. Dehn, P. Castracane, A. Butz, R. Kleinschek, A. Luther, J. Chen, R. Harig, G. Surawicz, W.R. Simpson, N. Jacobs, M. Grutter, W. Stremme, N. Jones, D. W. Griffith, G. Mengistu Tsidu, K. Shiomi, I Morino, S. Wofsy, O. Garcia, D. Pollard, M. Dubey, D. Wunch, P.O. Wennberg, M.K. Sha, H. Gadhavi, D. Ene, M. Ramonet, Y. Sun, and H. Boesch, COCCON - a framework for operating the EM27/SUN spectrometer, 2nd Sentinel-5P Validation Team Meeting and 1st Results Workshop, Noordwijk (Netherlands), 5-6 February, 2018.
- Kulawik, Susan S., Christopher O'Dell, Greg Osterman, Paul Wennberg, Debra Wunch, Coleen Roehl, Nicholas Deutscher, Matthäus Kiel, David Griffith, Voltaire Velazco, Justus Notholt, Thorsten Warneke, Christof Petri, Martine De Maziere, Mahesh Kumar Sha, Sussmann, Ralf, Rettinger, Markus, Dave Pollard, Isamu Morino, Osamu Uchino, Frank Hase, Dietrich Feist, Kimberly Strong, Rigel Kivi, Laura Iraci, Kawakami Shuji, Manvendra Dubey, Eliezer Sepulveda, Omaira Elena Garcia Rodriguez, Yao Te, Pascal Jeseck, Matt Kiel, Pauli Heikkinen, Matthias Schneider, Steve Wofsy, Kathryn McKain, Colm Sweeney, David Baker, and Junjie Liu, Characterization of OCO-2 biases and errors for flux estimates, 14th International Workshop on Greenhouse Gas Measurements from Space (IWGGMS-14), Toronto (Canada), 8-10 May, 2018.
- León-Luis, S.F., Carreño, V., Redondas, A., Henriques, D., Moniz, L. Campaña intercomparación Brewer 2017: Calibración del Brewer #102. Acta de las XXXV Jornadas Científicas de la Asociación Meteorológica Española. León, Spain, 5-7 March 2018, <https://doi.org/10.30859/ameJrCn35p219>, 2018.
- León-Luis, S.F., Carreño, V., Redondas, A., Santana-Díaz, D., López-Solano, J., Rodríguez-Válido, M. Centro de Calibración Regional Brewer – Europa (RBCC-E): Estabilidad de las medidas de ozono realizadas en el observatorio Atmosférico de

- Izaña. Acta de las XXXV Jornadas Científicas de la Asociación Meteorológica Española. León, Spain, 5-7 March 2018, <https://doi.org/10.30859/ameJrCn35p213>, 2018.
- López-Solano, J., Redondas, A., Carlund, T., Rodríguez-Franco, J. J., Diémoz, H., León-Luis, S. F., Hernández-Cruz, B., Guirado-Fuentes, C., Kouremeti, N., Gröbner, J., Kazadzis, S., Carreño, V., Berjón, A., Santana-Díaz, D., Rodríguez-Valido, M., De Bock, V., Moreta, J. R., Rimmer, J., Smedley, A.R.D., Boulkelia, L., Jepsen, N., Eriksen, P., Bais, A. F., Shiroto, V., Vilaplana, J. M., Wilson, K. M., and Karppinen, T. UV Aerosol Optical Depth in the European Brewer Network. 9th International Workshop on Sand/Dust storms and Associated Dustfall, La Laguna, Tenerife, Spain, 22-24 May 2018.
- López-Solano, J., Rodríguez, S., Pérez García-Pando, C., Sosa, E., García, M. I., Bustos, J.J., Marrero, C. and Alonso-Pérez, S. Northern African sources of mineral dust from measurements at the Izaña GAW Observatory. 9th International Workshop on Sand/Dust storms and Associated Dustfall, La Laguna, Tenerife, Spain, 22-24 May 2018.
- Milford, C., Cuevas, E., Marrero, C., Bustos, J.J., Torres, C. Air quality trends in a coastal city, Santa Cruz de Tenerife. 11th International Conference on Air Quality - Science and Application, Barcelona, Spain, 12-16 March 2018.
- Prats, N., González, P., Sanz, R., Extraordinary lightning episode during 12th and 13th of August 2015 in Canary region, was it the effect of dust aerosols? 9th International Workshop on Sand/Dust storms and Associated Dustfall, La Laguna, Tenerife, Spain, 22-24 May 2018.
- Rodríguez, S., Lucarelli, F., Nava, S., García, M.I., López-Solano, J., Marrero, C., Cuevas, E., Prats, N., High variability of dust composition in the Saharan Air Layer. 9th International Workshop on Sand/Dust storms and Associated Dustfall, La Laguna, Tenerife, Spain, 22-24 May 2018.
- Redondas, A., NDACC Brewer, Steering committee meeting of the Network for the Detection of Atmospheric Composition Change (NDACC), WMO Headquarters, Geneva, Switzerland, September 10-13, 2018.
- Saviz Sehatkashani, Emilio Cuevas, Carmen Guirado-Fuentes, Mehdi Rashidzad, Gerardo Garcia-Castrillo, Abbas Ranjbar, Aerosol characterization using Calitoo hand-held sunphotometer at the District 22 of Tehran, 9th International Workshop on Sand/Dust storms and Associated Dustfall, Tenerife (Spain), 22-24 May 2018.
- Sosa, E., Rodríguez, S., García, M.I., López-Solano, Prats, N., Assessing the response of a TEOM dichotomous FDMS and BETA monitors to aerosol dust in the Saharan Air Layer. 9th International Workshop on Sand/Dust storms and Associated Dustfall, La Laguna, Tenerife, Spain, 22-24 May 2018.
- Tarasick, D.W., I.E. Galbally, O.R. Cooper, M.G. Schultz, G. Ancellet, T. Leblanc, T.J. Wallington, J. Ziemke, X. Liu, M. Steinbacher, J. Staehelin, C. Vigouroux, J. Hannigan, O. García, G. Foret, P. Zanis, E. Weatherhead, I. Petropavlovskikh, H. Worden, M. Osman, J. Liu, M. Lin, M. Granados-Muñoz, A.M. Thompson, S.J. Oltmans, J. Cuesta, G. Dufour, V. Thouret, B. Hassler and T. Trickl, Tropospheric Ozone Assessment Report: Tropospheric ozone observations – How well do we know tropospheric ozone changes?, SPARC General Assembly 2018, Kyoto (Japan), 1-5 October, 2018.
- Terradellas, E., C. Camino, S. Alonso-Pérez, S. Basart, J.M. Baldasano, E. Cuevas, Distribución espacial y temporal de polvo mineral atmosférico en el Norte de África y Oriente Medio estimada a partir de observaciones de visibilidad horizontal, Acta de las Jornadas Científicas de la Asociación Meteorológica Española, 32, 8 de julio, 2018.
- ## 2017
- Barreto, A., R. Román, E. Cueva, A. Berjón, A.F. Almansa, C. Toledano, R. González, Y. Hernández, L. Blarel, P. Goloub, C. Guirado, M. Yela, Nocturnal aerosol monitoring using CE318 at Izaña high-mountain Observatory (2011-2017), Lunar Photometry Workshop 2017, Tenerife (Spain), 7-8 June 2017.
- Barreto, Á., Nocturnal aerosol monitoring in Izaña high mountain station with CE318T, Lunar Photometry Workshop, Izaña, Tenerife, 7-8 June 2017.
- Cachorro, V. E., D. Mateos, M.A. Burgos, Y.S. Bennouna, C. Toledano, R. González, C. Velasco-Merino, C. Guirado, A. Berjón, A. Calle, A.M. De Frutos, Similarities and discrepancies when surface and columnar aerosol data are jointly analysed in a background environment, 5th Iberian Meeting on Aerosol Science and Technology (RICTA 2017), Barcelona (Spain), 3-6 July 2017.
- Cuevas, E., Ground Observation, SDS-WAS: Dust observation Side Event, GAW Symposium 10-13 April 2017.
- Cuevas, E., Evolution of the aerosols-related programs at the Izaña Atmospheric Research Centre (IARC), ACE20: Future North Atlantic Atmospheric Observation Systems. Assessing the legacy of ACE2, Hotel Mencey, Santa Cruz de Tenerife, Spain, 4-6 July 2017.
- Cuevas, E., Cambio climático en Canarias: posibles impactos en la agricultura, Valle Guerra, Foro Innovagro Canarias, Instituto Canario de Investigaciones Agrarias (ICIA), September 22nd, 2017.
- Cuevas, E., E. Terradellas, and S. Nickovic, Sand and Dust Storm Advisory, 10th Session WWRP Scientific Steering Committee (WWRP SSC10), Geneva, WMO Headquarters, 25-26 October 2017.
- García, R.D., E. Cuevas, A. Barreto, V. Cachorro, R. Ramos, C. Guirado, C. Toledano and K. Hoogendijk, Preliminary results of Aerosol Optical Depth and Angstrom Exponent at the Izaña Atmospheric Observatory from spectral direct irradiance measured with an EKO MS-711 spectroradiometer, 44th Annual European Meeting on Atmospheric Studies by Optical Methods, 4-8 September, Barcelona, Spain, 2017.
- García, O., and E. Cuevas, Monitorización de las Concentraciones de GEIs en Ambientes Urbanos: EM27/SUN, Jornada Técnica sobre los servicios de Atmósfera y Clima de Copernicus, Agencia Estatal de Meteorología (AEMET), November 27th, 2017.
- García, O.E., E. Sepúlveda, M. Schneider, A. Wiegeler, C. Borger, F. Hase, E. Sanromá, Á.-J. Gómez-Pelaéz, A. Cansado, M. Aullé, and S. Barthlott, INMENSE: IASI for Surveying Methane and Nitrous Oxide in the Troposphere, EUMETSAT Meteorological Satellite Conference, Roma, 2-6 October, 2017.
- Goloub, P., C. Toledano, E. Cuevas, WP7: AERONET-Europe, ACTRIS-2 Mid-time Review Meeting, Granada, Spain January 31, 2017.
- Gomez-Pelaez, A.J., R. Ramos, V. Gomez-Trueba, E. Cuevas, E. Reyes; "CO₂, CH₄, and CO with CRDS technique at the Izaña Global GAW station: instrumental tests, developments and first measurement results" presented at "19th WMO/IAEA Meeting on Carbon Dioxide, Other Greenhouse Gases, and Related Measurement Techniques (GGMT-2017)", Dubendorf, Switzerland, August 27-31, 2017.

- Mateos, D., V. Cachorro, C. Toledano, C. Velasco-Merino, M.A. Burgos, R. González, S. Blindheim, M. Gausa, A. Berjón, C. Guirado, A. Calle, A.M. de Frutos, Aerosol radiative effect in the shortwave range for the extreme aerosol events registered with Sun photometry in a pristine subarctic area, NOSA Aerosol Symposium 2017, Lund (Sweden), 20-22 March 2017.
- Rimmer, J. S., A Redondas, J Groebner, T Karprinen, V de Book , A Bais, The European COST Action EUBrewNet: Towards consistency in quality control, quality assurance and coordinated operations of the Brewer Instrument, The 10th meeting of the Ozone Research Managers of the Parties to the Vienna Convention, Geneva 28th - 30th March 2017.
- Sanromá, E., O.E. García, F. Hase, M. Schneider, T. Blumenstock, E. Sepúlveda, A. Redondas, M. Navarro-Comas, and V. Carreño, Improved Retrieval Strategy for Ozone Monitoring by Ground-Based FTIR Spectrometry, NDACC/IRWG and TCCON Meeting, Paris (France), 29 May-02 June, 2017.
- Sanromá, E., O.E. García, M. Schneider, F. Hase, T. Blumenstock, and E. Sepúlveda, Ozone Isotopologue Monitoring from Ground-Based FTIR Spectrometry, NDACC/IRWG and TCCON Meeting, Paris (France), 29 May-02 June, 2017.
- Schulz, M., H.J. Eskes, H. Clark, Y. Christophe, M. Ramonet, S. Basart, A. Benedictow A.-M. Blechsmidt, S. Chabrilat, E. Cuevas, H. Flentje, K.M. Hansen, U. IM, J. Kapsomenakis, B. Langerock, K. Petersen, A. Richter, N. Sudarchikova, V. Thouret, A. Wagner, T. Warneke, C. Zerefos, Validation of the reanalysis for the year 2003, CAMS GA in Warsawa (Poland), May 16, 2017.
- Sepúlveda, E., O.E. García, M. Schneider, T. August, T. Hultberg, C. Clerbaux, J. Hadji-Lazaro5, P.-F. Coheur, D. Hurtmans, F. Hase, T. Blumenstock, E. Sanromá, V. Carreño, E. Mahieu, M. De Mazière, C. Vigouroux, D. Griffith, N. Jones, D. Smale, J. Notholt, M. Palm, A. M. De Frutos, Ozone Monitoring Comparison as observed by the satellite-based METOP-IASI and ground-based NDACC FTS, EUMETSAT Meteorological Satellite Conference, Roma, 2-6 Octubre, 2017.
- Sepúlveda, E., O.E. García, M. Schneider, T. August, C. Clerbaux, F. Hase, T. Blumenstock, T. Hultberg, E. Sanromá, V. Carreño, E. Mahieu, M. De Mazière, C. Vigouroux, D. Griffith, N. Jones, D. Smale, J. Notholt, M. Palm, and A. M. De Frutos, Ozone total and partial column amounts comparison between satellite-based MetOp-IASI and ground-based NDACC FTIR, NDACC/IRWG and TCCON Meeting, Paris (France), 29 May-02 June, 2017.
- Sepúlveda, E., O.E. García, M. Schneider, F. Hase, T. Blumenstock, and E. Sanromá, The Izaña Site Report, NDACC/IRWG and TCCON Meeting, Paris (France), 29 May-02 June, 2017.
- Velasco-Merino,C., D. Mateos, C. Toledano, V. Cachorro, R. González, M.A. Burgos, S. Blindheim, M. Gausa, A. Berjón, C. Guirado, A. Calle, A.M. de Frutos, Long-term aerosol characterization in a sub-Arctic area using sun photometer data: columnar optical and microphysical properties, NOSA Aerosol Symposium 2017, Lund (Sweden), 20-22 March 2017.
- Velasco-Merino,C., D. Mateos, C. Toledano, V. Cachorro, R. González, M.A. Burgos, S. Blindheim, M. Gausa, A. Berjón, C. Guirado, A. Calle; A.M. de Frutos, Overview of sun photometer measurements of aerosol radiative properties in a pristine Sub-Arctic area, 5th Iberian Meeting on Aerosol Science and Technology (RICTA 2017), Barcelona (Spain), 3-6 July 2017.
- Velasco-Merino, C., D. Mateos, C. Toledano, V. Cachorro, R. González, M.A. Burgos, S. Blindheim, M. Gausa, A. Berjón, C. Guirado, A. Calle, and A.M. de Frutos, 15-year measurements of aerosol optical and microphysical properties in Andenes (69°N, 16°E) site, 44th Annual European Meeting on Atmospheric Studies by Optical Methods, Barcelona (Spain), 4-8 September 2017.

23.3 Non-peer reviewed papers and reports

2018

- Basart, S.; Benedictow, A.; Bennouna, Y.; Blechschmidt, A.-M.; Chabrilat, S.; Clark, H.; Cuevas, E.; Flentje, H.; Hansen, Kaj Mantzius; Im, Ulas; Kapsomenakis, J.; Langerock, B.; Petersen, K.; Richter, A.; Sudarchikova, N.; Thouret, V.; Warneke, T.; Zerefos, C., Validation report of the CAMS near-real time global atmospheric composition service March - May 2018, Copernicus Atmosphere Monitoring Service (CAMS) Report, 2443544147, 2018.
- Basart, S.; Benedictow, A.; Bennouna, Y.; Blechschmidt, A.-M.; Chabrilat, S.; Christophe, Y.; Clark, H.; Cuevas, E.; Eskes, H.; Hansen, Kaj Mantzius; Im, Ulas; Kapsomenakis, J.; Langerock, B.; Petersen, K.; Schulz, Wagner, A.; Zerefos, C., Addendum to: Upgrade verification note for the CAMS near-real time global atmospheric composition service Evaluation of the e-suite experiment gu42, Copernicus Atmosphere Monitoring Service (CAMS) Report, 2443544151, 2018.
- Eskes, H.; Antonakaki, T.; Basart, S.; Benedictow, A.; Blechschmidt, A.-M.; Chabrilat, S.; Christophe, Y.; Clark, H.; Cuevas, E.; Hansen, Kaj Mantzius; Im, Ulas; Kapsomenakis, J.; Langerock, B.; Petersen, K.; Richter, A.; Schulz, M.; Sudarchikova, N.; Thouret, V.; Wagner, A.; Zerefos, C.; Upgrade verification note for the CAMS near real time global atmospheric composition service Evaluation of the e-suite (experiment gp1p) for the period November 2016 - May 2017, Copernicus Atmosphere Monitoring Service (CAMS) Report, 2443544157, 2018.
- Eskes, H.; Wagner, A.; Schulz, M; Christophe, Y.; Ramonet, M.; Basart, S.; Benedictow, A.; Bennouna, Y.; Blechschmidt, A.-M.; Chabrilat, S.; Clark, H.; Cuevas, E.; Flentje, H.; Hansen, Kaj Mantzius; Im, Ulas; Kapsomenakis, J.; Langerock, B.; Petersen, K.; Richter, A.; Sudarchikova, N.; Thouret, V.; Warneke, T.; Zerefos, C., Validation report of the CAMS near-real time global atmospheric composition service December 2017 – February 2018, Copernicus Atmosphere Monitoring Service (CAMS) Report, 2443544144, 2018.
- Eskes, H.; Wagner, A.; Schulz, M; Christophe, Y.; Ramonet, M.; Basart, S.; Benedictow, A.; Bennouna, Y.; Blechschmidt, A.-M.; Chabrilat, S.; Clark, H.; Cuevas, E.; Flentje, H.; Hansen, Kaj Mantzius; Im, Ulas; Kapsomenakis, J.; Langerock, B.; Petersen, K.; Richter, A.; Sudarchikova, N.; Thouret, V.; Warneke, T.; Zerefos, C., Validation report of the CAMS near-real-time global atmospheric composition service. Period September-November 2017, Copernicus Atmosphere Monitoring Service (CAMS) Report, 2443486608, 2018.
- García, O.E., Sepúlveda, E., Schneider, M., Hase, F., Gómez-Peláez, A.J., Reyes, E., del Campo, R., Cansado, A., Aullé, M., Sanromá, E., Informe Intermedio de Proyecto I+D+i "IASI para Sondear el Metano y Óxido Nitroso en la Troposfera", Agencia Estatal de Investigación, Ministerio de Ciencia, Innovación y Universidades, Septiembre, 2018.
- Sudarchikova, N.; Basart, S.; Katragkou, Eleni; Petersen, K.; Akritidis, S.; Kartsios, S.; Zanis, P.; Melas, D.; Chabrilat, S.; Christophe, Y.; Ramonet, M.; Bennouna, Y.; Clark, H.; Wagner, A.; Schulz, M.; Blechschmidt, A.-M.; Cuevas, E.; Flentje, H.; Hansen, Kaj Mantzius; Kapsomenakis, J.; Langerock, B.; Warneke, T.; Eskes, H. Compendium of case

studies for the period 2015-2018, Copernicus Atmosphere Monitoring Service (CAMS) Report, 2443544159, 2018.

2017

Antonakaki, T.; Basart, S.; Benedictow, A.; Blechschmidt, A.-M.; Chabrillat, S.; Clark, H.; Cuevas, E.; Eskes, H.J.; Hansen, Kaj Mantzius; Im, Ulas; Kapsomenakis, J.; Langerock, B.; Petersen, K.; Richter, A.; Schulz, M.; Sudarchikova, N.; Thouret, V.; Wagner, A.; Zerefos, C., Upgrade verification note for the CAMS near-real time global atmospheric composition service, Copernicus Atmosphere Monitoring Service (CAMS) Report, 2394630730, 2017.

Antonakaki, T.; Basart, S.; Benedictow, A.; Blechschmidt, A.-M.; Chabrillat, S.; Christophe, Y.; Clark, H.; Cuevas, E.; Eskes, H.J.; Hansen, Kaj Mantzius; Im, Ulas; Kapsomenakis, J.; Langerock, B.; Ramonet, M.; Richter, A.; Schulz, M.; Sudarchikova, N.; Wagner, A.; Warneke, T.; Zerefos, C., Evaluation of the CAMS 2010 reanalysis test run experiment gls8, Copernicus Atmosphere Monitoring Service (CAMS) Report, 2394630729, 2017.

Basart, S.; Blechschmidt, A.-M.; Chabrillat, S.; Clark, H.; Cuevas, E.; Eskes, H.J.; Flentje, H.; Hansen, Kaj Mantzius; Kapsomenakis, J.; Katragkou, E.; Langerock, B.; Petersen, K.; Ramonet, M.; Richter, A.; Schulz, M.; Wagner, A.; Zerefos, C., Data Mining: potential new observations for the CAMS validation activity, Copernicus Atmosphere Monitoring Service (CAMS) Report, 2394630726, 2017.

Cuevas, E., Milford, C., Bustos, J. J., del Campo-Hernández, R., García, O. E., García, R. D., Gómez-Peláez, A. J., Guirado-Fuentes, C., Marrero, C., Prats, N., Ramos, R., Redondas, A., Reyes, E., Rodríguez, S., Romero-Campos, P. M., Schneider, M., Belmonte, J., Yela, M., Almansa, F., Barreto, A., López-Solano, C., Basart, S., Terradellas, E., Afonso, S., Bayo, C., Berjón, A., Bethencourt, J., Carreño, V., Castro, N. J., Cruz, A. M., Damas, M., De Ory-Ajamil, F., García, M.I., Gómez-Trueba, V., González, Y., Hernández, C., Hernández, Y., Hernández-Cruz, B., Jover, M., León-Luís, S. F., López-Fernández, R., López-Solano, J., Rodríguez, E., Rodríguez-Franco, J. J., Rodríguez-Valido, M., Sálamo, C., Sanromá, E., Santana, D., Santo Tomás, F., Sepúlveda, E., Sierra, M. and Sosa, E.: Izaña Atmospheric Research Center Activity Report 2015-2016. (Eds. Cuevas, E., Milford, C. and Tarasova, O.), State Meteorological Agency (AEMET), Madrid, Spain and World Meteorological Organization, Geneva, Switzerland, NIPO: 014-17-012-9, WMO/GAW Report No. 236, 2017.

Douros, J.; Basart, S.; Benedictow, A.; Blechschmidt, A.-M.; Chabrillat, S.; Christophe, Y.; Clark, H.; Cuevas, E.; Eskes, H.J.; Flentje, H.; Hansen, Kaj Mantzius; Kapsomenakis, J.; Langerock, B.; Petersen, K.; Ramonet, M.; Richter, A.; Schulz, M.; Wagner, A.; Warneke, T.; Zerefos, C., Observations characterization and validation methods document, Copernicus Atmosphere Monitoring Service (CAMS) Report, 2394630727, 2017.

Eskes, H.; Clark, H.; Schulz, M.; Christophe, Y.; Ramonet, M.; Basart, S.; Benedictow, A.; Blechschmidt, A.-M.; Chabrillat, S.; Cuevas, E.; Flentje, H.; Hansen, Kaj Mantzius; Im, Ulas; Jossoud, O.; Kapsomenakis, J.; Langerock, B.; Petersen, K.; Richter, A.; Sudarchikova, N.; Thouret, V.; Wagner, A.; Warneke, T.; Zerefos, C., Validation report for the CAMS global reanalyses of aerosols and reactive trace gases, year 2003, Copernicus Atmosphere Monitoring Service (CAMS) Report, 2394630728, 2017.

Eskes, H.J., A. Wagner, M. Schulz, Y. Christophe, M. Ramonet, S. Basart, A. Benedictow, A.-M. Blehsmidt, S. Chabrillat, H. Clark, E. Cuevas, H. Flentje, K.M. Hansen, U. IM, J.

Kapsomenakis, B. Langerock, K. Petersen, A. Richter, N. Sudarchikova, V. Thouret, T. Warneke, C. Zerefos, Validation Report of the CAMS Near-Real Time Global Atmospheric Composition Service: December 2016-February 2017, Copernicus Atmosphere Monitoring Service (CAMS) Report, CAMS84_2015SC2_D84.1.1.7_2017DJF_v1.pdf, MAY 2017.

Eskes, H.J., A. Wagner, M. Schulz, Y. Christophe, M. Ramonet, S. Basart, A. Benedictow, A.-M. Blechschmidt, S. Chabrillat, H. Clark, E. Cuevas, H. Flentje, K.M. Hansen, U. IM, J. Kapsomenakis, B. Langerock, A. Richter, N. Sudarchikova, V. Thouret, T. Warneke, C. Zerefos, Validation Report of the CAMS Near-Real-Time Global Atmospheric Composition Service: September-November 2016, Copernicus Atmosphere Monitoring Service (CAMS) Report, CAMS84_2015SC2_D84.1.1.6_2016SON_v1.pdf, February 2017.

Romero-Campos, P.M.; Cuevas-Agulló, E.; Kazadzis, S.; Kouremeti, N.; García, R.D.; Guirado-Fuentes, C., Análisis de la trazabilidad en los valores del AOD obtenidos a partir de las medidas de las redes AERONET-CIMEL y GAW-PFR durante el período 2005-2015 en el Observatorio Atmosférico de Izaña, Notas técnicas de AEMET;23, AEMET - Publicaciones en línea, <http://hdl.handle.net/20.500.11765/7572>, 2017.

23.4 Peer reviewed papers (2000-2018)

The annual number of peer-reviewed papers and citations since 2000 are shown in Figure 23.1. The current IARC h-index is 42, and its publications have been cited 6,353 times in 4,605 papers.

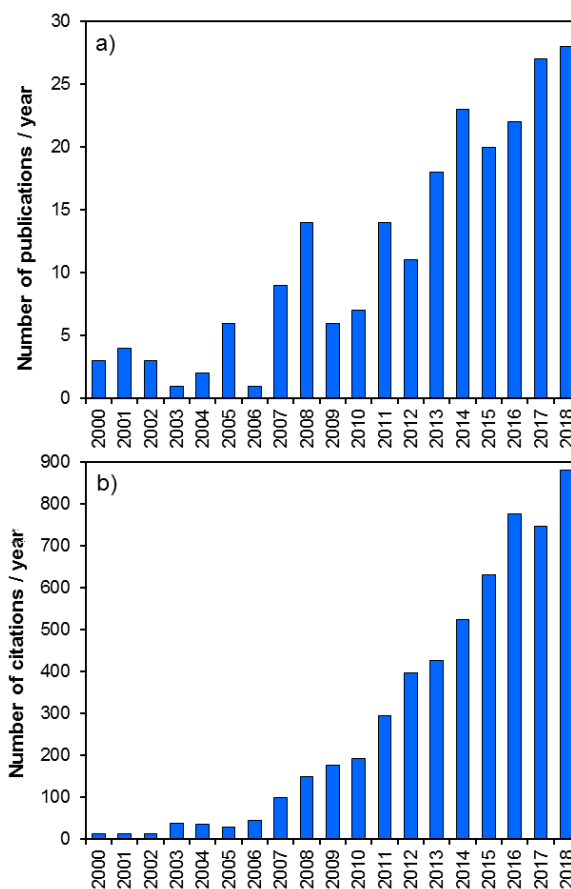

Figure 23.1. Izaña Atmospheric Research Center: a) number of peer-reviewed papers per year and b) citations per year.

24 PhD Theses

This section briefly describes the Doctoral Theses that have been supervised and co-supervised by researchers at IARC in the period 2017-2018.

María Isabel García Álvarez defended her PhD Thesis entitled “Origin of atmospheric aerosols transported across the North Atlantic free troposphere” on 20 July 2017 at the Izaña Atmospheric Observatory. The thesis was supervised by Dr Sergio Rodríguez (IARC-AEMET), Dr Andrés Alastuey (Research Council of Spain, CSIC) and Dr Barend Van Drooge (Research Council of Spain, CSIC). Tutor: Dr Luis R. Galindo Martín (University of La Laguna).



Figure 24.1. From left to right: Dr Juan Carlos Guerra (University of La Laguna), Dr Celia Alves (University of Aveiro), Dr M. Isabel García Álvarez and Dr Begoña Artíñano (CIEMAT) after the PhD defence at Izaña Atmospheric Observatory on 20th July 2017.

Dr María Isabel García Álvarez was honoured with the maximum qualification “Excellent Cum Laude” by the panel of expert examiners composed by Dr Begoña Artíñano (Research Centre for Energy, Environment and Technology-CIEMAT), Dr Celia Alves (University of Aveiro) and Dr Juan Carlos Guerra (University of La Laguna).

This Doctoral Thesis work focused on the origin of atmospheric aerosols in the North Atlantic free troposphere and was based on measurements at Izaña Observatory. The study focused on three air streams:

- 1) The free troposphere westerlies, which bring aged aerosols emitted in North America, including sulphate linked to coal power plants emissions, agriculture dust from the High Plains and soot emitted in large urban areas.
- 2) The Sahara Air Layer, where dust is usually mixed with some organic aerosols whose origin have been linked to

vegetation (both secondary organic aerosols and debris) and some antropogenic compounds (including oil lubricants).

3) Upslope winds that blows at mountain sites above Tenerife, which it has been observed that new particle formation occurs about the 30% of the days of the year, linked to the photo-oxidation of sulphur dioxide (emitted by ships and power and oil refining plants) and compounds emitted by the vegetation.

More information on the Thesis defence can be found [here](#).

Download the Thesis manuscript [here](#).

Judit Carrillo Pérez defended her PhD Thesis entitled “Thermodynamic structure of the subtropical troposphere in North Atlantic Ocean” on 12 September 2017 at the University of La Laguna. The thesis was supervised by Dr Juan Carlos Guerra (University of La Laguna) and Dr Emilio Cuevas (IARC-AEMET).



Figure 24.2. From left to right: Dr Juan Carlos Guerra (University of La Laguna), Dr José Luis Martín Esquivel (Teide National Park), Judit Carrillo Pérez, Dr Silvia Alonso-Pérez (Universidad Europea de Canarias), and Dr Emilio Cuevas (IARC-AEMET) after the PhD defence at the University of La Laguna on 12 September 2017.

Dr Judit Carrillo Pérez was honoured with the maximum qualification “Excellent Cum Laude” by the panel of expert examiners composed by Dr José Luis Martín Esquivel (Teide National Park), Dr Silvia Alonso-Pérez (Universidad Europea de Canarias) and Dr Juan Carlos Guerra (University of La Laguna).

Download the Thesis manuscript [here](#).

Carmen Yballa Hernández Pérez defended her PhD Thesis entitled “Vertical structure characterization of aerosols above the eastern subtropical region of the North Atlantic” on 19 September 2017 at the University of La Laguna. This work was developed in the Izaña Atmospheric Research Center (AEMET) and was supervised by Dr África Barreto (Cimel Electronique, France), Dr Alberto Berjón (University of Valladolid) and Dr Manuel Arbelo (University of La Laguna).



Figure 24.3. From left to right: Dr Africa Barreto (supervisor), Dr Francisco Javier Expósito (president of the thesis committee), Dr Rosa García (member of the thesis committee), Dr Yballa Hernández, Dr Manuel Arbelo (supervisor), Dr Alberto Berjón (supervisor) and Dr María José Granados (secretary of the thesis committee) after the PhD defense at the University of La Laguna, on 19 September 2017.

Dr Carmen Yballa Hernández Pérez was honoured with the maximum qualification “Excellent Cum Laude” by the panel of expert examiners composed by Dr Francisco Javier Expósito González (University of La Laguna), Dr María José Granados Muñoz (Polytechnic University of Cataluña) and Dr Rosa Delia García Cabrera (Air Liquide España).

The main objective of this thesis was the characterization of atmospheric aerosols in the eastern subtropical region of the North Atlantic, using the LIDAR technique and solar photometry. For the inversion of the LIDAR equation the investment methodology has been applied to one and two layers, the latter being novel within the study region, which is divided into two layers: the marine boundary layer and the free troposphere, separated by the thermal inversion associated to the Alisios winds.

For the accomplishment of the work a series of data of almost a decade has been used, which indicates the quality of the stations of measurement, the favorable atmospheric conditions, as well as the work done in the operation of the instruments.

In this work, a series of aerosol layers in the upper troposphere and low stratosphere were also detected and analyzed using LIDAR. The Transmittance and Inversion

methodology of the LIDAR equation was combined with other tools such as backtrajectories (to see the origin of the air masses), MODIS, NAAPS and CALIOP images. Four cases of study were distinguished: one of volcanic origin (Nabro volcano, Eritrea) and three fires (North America and Canada). It should be noted that the study of the eruption of the volcano Nabro carried out in the Thesis covers a time interval of approximately three months, which is the longest study performed up to the time of the event. The thesis committee highlighted the great scientific interest of this thesis, not only for the strategic study area but also because of the nine-year LIDAR database.

More information on the Thesis defence can be found [here](#).

Download the Thesis manuscript [here](#).

Ángel J. Gómez-Peláez successfully defended his PhD Thesis entitled “Measurement and transport of greenhouse gases, carbon monoxide and Saharan dust, with special emphasis on the free troposphere of the subtropical Northeast Atlantic” on 4 December 2018 at the University of Granada. The thesis was supervised by Dr Emilio Cuevas (IARC-AEMET) and Prof. Fernando Moreno-Insertis (Institute of Astrophysics of the Canary Islands-University of La Laguna). The academic tutor was Dr Francisco José Olmo-Reyes (University of Granada).

Dr Ángel J. Gómez-Peláez was honoured with the maximum qualification “Excellent Cum Laude” by the thesis tribunal composed of Dr Arturo Quirantes (University of Granada), Dr Victoria Cachorro (University of Valladolid), Dr Yolanda Luna (AEMET), Dr Manuel Arbelo (University of La Laguna) and Dr Inmaculada Foyo (University of Granada).



Figure 24.4. From left to right: Dr Emilio Cuevas (IARC-AEMET), Dr Victoria Cachorro (University of Valladolid), Dr Arturo Quirantes (University of Granada), Dr Yolanda Luna (AEMET), Dr Ángel Gómez (AEMET), Dr Manuel Arbelo (University of La Laguna), Dr Inmaculada Foyo (University of Granada) and Dr Fernando Moreno (University of La Laguna) after the PhD defence at the University of Granada, on 4 December 2018.

More information on the Thesis defence can be found [here](#).

Download the Thesis manuscript [here](#).

24.1 On-going PhD Theses

The theses that are currently in progress in the Izaña Atmospheric Research Center are:

1. Fernando Almansa: “Atmospheric aerosols detection by measuring the scattered solar radiation and emission in the thermal infrared spectral range”, University of Valladolid, Supervisors: Dr Emilio Cuevas (IARC-AEMET) and Prof. Dr Angel de Frutos (University of Valladolid).
2. Niobe Peinado: “Validation of the IASI ozone retrievals with ground based measurements and other satellite data”, University of Valencia, Supervisors: Prof. Ernesto López-Baeza (University of Valencia), Dr Xabier Calbet (EUMETSAT), and Dr Omaira García (IARC-AEMET).

25 List of scientific projects

Table 25.1. List of scientific projects at IARC during 2017-2018.

Project Title	Duration	Funding Agency	Project Website	Principal Investigator/ Contact
Medida de Gases de Efecto Invernadero en Ambientes Urbanos (MEGEI)	2018-ongoing	Meteorological State Agency (AEMET)	—	PI (IARC-AEMET): Dr Omaira García
MOisture Transport and Isotopologues of water Vapour (MOTIV)	2017-2020	Deutsche Forschungsgemeinschaft SCHN 1126/2-1	—	PI (KIT): Dr Matthias Schneider PI (IARC-AEMET): Dr Omaira García
Equipment for the monitoring and research of the atmospheric parameters and components that modulate climate change, at the Izaña Global GAW station (MICA)	2018-2019	Spanish Ministry of Economy, Industry and Competitiveness	—	PI (IARC-AEMET): Dr Emilio Cuevas
ACTRIS PPP - Aerosols, Clouds and Trace gases Preparatory Phase Project	2017-2019	H2020-INFRADEV-2016-2017 (H2020)	https://www.actris.eu/Projects/ACTRISPPP(2017-2019).aspx	PI (FMI): Dr Sanna Sorvari PI (IARC-AEMET): Dr Natalia Prats
IASI para sondear el Metano y Óxido de Nitroso en la Troposfera (INMENSE)	2017-2019	Spanish Ministry of Economy, Industry and Competitiveness CGL2016-80688-P	—	PI (IARC-AEMET): Dr Omaira García
Multidecadal variability and trends of aerosol properties in the North Atlantic (AEROATLAN)	2016-2018 (extension 2019)	Spanish Ministry of Economy and Competitiveness	http://aeroatlan.aemet.es/	PI (IARC-AEMET): Dr Sergio Rodríguez
Aerosols, Clouds, and Trace gases Research InfraStructure (ACTRIS-2)	2015-2019	H2020-INFRAIA-2014-2015 (H2020)	http://www.actris.eu/	PI (CNR-IMAA): Dr Gelsomina Pappalardo PI (IARC-AEMET): Dr Emilio Cuevas
Equipamiento para la Monitorización e Investigación en la estación Global VAG (Vigilancia Atmosférica Global) de Izaña (Tenerife) de componentes atmosféricos que provocan y modulan el cambio climático	2016-2017	Spanish Ministry of Economy and Competitiveness	—	PI (IARC-AEMET): Dr Emilio Cuevas
Traceability of the Atmospheric total column ozone (ATMOZ)	2014-2017	EURAMET/EMRP	http://projects.pmodwrc.ch/atmoz/	PI (WRC): Dr Julian Gröbner PI (IARC-AEMET): Alberto Redondas

EGB-SVN EarthCare Ground Base-Spectrometer Validation Network (Pandonia network)	2014-2017	European Space Agency/LuftBlick	http://www.pandonia.net/	PI (ESA/LuftBlick): Dr Alexander Cede PI (IARC-AEMET): Alberto Redondas
Validation of IASI Level 2 products (VALIASI)	2015-2017	EUMETSAT	—	PI (IARC-AEMET): Dr Omaira García
SDS-Africa	2007-ongoing	Spanish Agency for International Development Cooperation	—	PI (IARC-AEMET): Dr Emilio Cuevas
GAW-Sahara	2007-ongoing	Spanish Agency for International Development Cooperation	—	PI (IARC-AEMET): Alberto Redondas

For a definition of the acronyms used in the above table, see Section 28.

26 List of major national and international networks, programmes and initiatives

The Izaña Atmospheric Research Center participates in the following national and international networks, programmes and initiatives:

ACTRIS	Aerosols, Clouds, and Trace gases Research InfraStructure Network
AERONET	AERosol ROBotic NETwork
BSRN	Baseline Surface Radiation Network
CarbonTracker	CO ₂ measurement and modeling system developed by NOAA to keep track of sources and sinks of carbon dioxide around the world
CarbonTracker Europe	
COCCON	Collaborative Carbon Column Observing Network
EAN	European Aeroallergen Network
EARLINET	European Aerosol Research Lidar Network
E-GVAP	EUMETNET GPS water vapour Programme
EPN	EUREF Permanent Network
EUBREWNET	European Brewer Network
GAW	WMO Global Atmosphere Watch Programme
GCOS	Global Climate Observing System
GEOMON	Global Earth Observation and Monitoring of the Atmosphere
GLOBALVIEW-CO₂	
GLOBALVIEW-CH₄	
GLOBALVIEW-CO	
GLOBALVIEW-CO₂C₁₃	
GURME	WMO GAW Urban Research Meteorology and Environment project
ICOS	Integrated Carbon Observation System
LOTUS	Long-term Ozone Trends and Uncertainties in the Stratosphere
MACC	Monitoring Atmospheric Composition and Climate
MPLNet	Micro-Pulse Lidar NETwork
NDACC	Network for the Detection of Atmospheric Composition Change
NOAA/ESRL/GMD CCGG Cooperative Air Sampling Network	
PGN	Pandonia Global Network
PHOTONS	PHOTométrie pour le Traitement Opérationnel de Normalisation Satellitaire
RBCC-E	Regional Brewer Calibration Center for Europe
REA	Red Española de Aerobiología
REDMAAS	Red Española de DMAs Ambientales
SDS-WAS	WMO Sand and Dust Storm Warning, Advisory and Assessment System

SPALINET	Spanish and Portuguese Aerosol Lidar Network
SPARC	Stratosphere-troposphere Processes And their Role in Climate
TCCON	Total Carbon Column Observing Network
TOAR	Tropospheric Ozone Assessment Report
WCCAP	World Calibration Centre for Aerosol Physics
WDCGG	WMO GAW World Data Centre for Greenhouse Gases
WDCRG	WMO GAW World Data Center for Reactive Gases
WOUDC	World Ozone and Ultraviolet Data Center
WRC-WORCC	World Radiation Centre-World Optical Depth Research and Calibration Cente
WRC-WCC-UV	World Radiation Centre-World Calibration Center-Ultraviolet Section
WRDC	WMO World Radiation Data Centre

27 Staff

Research Staff			
Name	Position	Email	Personal Web Page
Dr Emilio Cuevas-Agulló	Izaña Atmospheric Research Center: Director	ecuevasATAemet.es	ResearchGate Google Scholar
Juan J. de Bustos-Seguela	Meteorology Programme McIdas and Eumetcast Manager	jbustossATAemet.es	ResearchGate
Dr Omaira E. García-Rodríguez	FTIR Programme: Head	ogarciarATAemet.es	ResearchGate Google Scholar
Dr Ángel J. Gómez-Peláez ^a	Greenhouse Gases and Carbon Cycle Programme: Former Head	agomezpATAemet.es	ResearchGate Google Scholar
Dr Yballa Hernández-Pérez ^a	LIDAR-Ceilometer	chernandezpATAemet.es	
Carlos L. Marrero de la Santa Cruz	Meteorology Programme: Head	cmarrerodATAemet.es	
Pedro Pablo Rivas Soriano ^b	Greenhouse Gases and Carbon Cycle Programme	privassATAemet.es	
Dr Natalia Prats Porta	In situ Aerosols Programme: Head	npratspATAemet.es	ResearchGate
Alberto Redondas-Marrero	Ozone and UV Programme: Head	aredondasmATAemet.es	ResearchGate Google Scholar
Pedro M. Romero-Campos	Radiation and Water Vapour Programme: Head	promerocATAemet.es	
Dr Sergio Rodríguez-González ^a	In situ Aerosols Programme: Former Head	srodriguezgATAemet.es	ResearchGate Google Scholar
Elba Rodríguez-Jiménez ^a	Reactive Gases Programme	erodriguezjATAemet.es	
Dr Esther Sanromá Ramos ^a	FTIR Programme	msanromarATAemet.es	ResearchGate
Dr Eliezer Sepúlveda	FTIR Programme	esepulvedahATAemet.es	ResearchGate
Dr Elisa Sosa Trujillo ^a	In situ Aerosols Programme	esosatATAemet.es	
Carlos J. Torres García ^b	Reactive Gases and Ozonesondes Programme: Head	ctorresgATAemet.es	

^aLeft IARC in 2017-2018, ^bJoined IARC in 2017-2019

Research Staff from other Institutions				
Name	Affiliation	Programme	Email	Personal Web Page
Antonio F. Almansa-Rodríguez	CIMEL/ UVA	UV-Vis Photodiode Array Spectrometer development	FernandoATsieltec.es	
Dr África Barreto	CIMEL/ UVA	Lunar Cimel developments, LIDAR	africavbATgmail.com	ResearchGate
Dr Alberto Berjón	TRAGSA TEC	Ozone and UV Programme/ Column Aerosols Programme	aberjonATtragsa.es	ResearchGate Google Scholar
Dr Isabel García-Alvarez ^a	ULL	In situ Aerosols Programme	mig.aerosolATAemet.es	
Dr Rosa D. García-Cabrera	AirLiquide /UVA	BSRN, Radiation Modelling	rosaATgoa.uva.es	ResearchGate Google Scholar
Vanessa Gómez Trueba	AirLiquide	Green House Gases Programme	vanessa.gomezATairliquid e.com	
Dr Carmen Guirado-Fuentes ^a	UVA	ACTRIS Project	carmenfATgoa.uva.es	ResearchGate Google Scholar
Bentorey Hernández-Cruz ^a	FGULL	Ozone and UV Programme	bhernandezATfg.ull.es	
Dr Javier López-Solano	TRAGSA TEC	Ozone and UV Programme/CIMO Testbed	jlopez15ATtragsa.es	ResearchGate
Dr Celia Milford		In situ Aerosols Programme	cmilford2ATgmail.com	ResearchGate
Daniel Santana	SIELTEC/ LuftBlick	Ozone and UV Programme	daniel.santanaATluftblick. at	

^aLeft IARC in 2017-2019

Technical Staff			
Name	Position	Email	Web Page
Sergio Afonso-Gómez	Meteorological Observer /GAW technician	safonsogATAemet.es	
Concepción Bayo-Pérez	Meteorological Observer /GAW technician	cbayopATAemet.es	
Virgilio Carreño-Corbella	Meteorological Observer /GAW technician	vcarrenocATAemet.es	
Néstor J. Castro-Quintero	IT specialist	ncastroqATAemet.es	
Antonio M. Cruz-Martín	IT specialist	acruzmaATAemet.es	
Dr Fernando de Ory-Ajamil ^a	Meteorological Observer /GAW technician	fdeoryaATAemet.es	
Cándida Hernández-Hernández	Meteorological Observer /GAW technician	chernandezhATAemet.es	
Dr Sergio León-Luís	Scientific instrumentation technician	sleonlATAemet.es	
Rocío López-Fernández	IT specialist	rlopezfATAemet.es	
Julián Pérez de la Puerta ^b	Meteorological Observer /GAW technician	jperezdATAemet.es	
Ramón Ramos-López	Scientific instrumentation and infrastructures: Head	rramoslATAemet.es	
Enrique Reyes-Sánchez	Scientific instrumentation and infrastructures	ereyessATAemet.es	

^aLeft IARC in 2017-2019, ^bJoined IARC in 2017-2019

Administration Staff			
Name	Position	Email	Personal Web Page
Dr Emilio Cuevas-Agulló	Izaña Atmospheric Research Center: Director	ecuevasaATaemet.es	ResearchGate Google Scholar
Marcos Damas-García	Driver	mdamasgATaemet.es	
Dr Natalia Prats Porta	Project Manager	nprataspATaemet.es	
Concepción Sálamo-Hernández ^a	Secretary	csalamohATaemet.es	
J. Félix Santo Tomás-Castro	Accounting officer	jsantotomascATaemet.es	

^aRetired in 2019

27.1 Tribute to Concha Sálamo-Hernández

In these pages we would like to pay a sincere tribute to our colleague Concepción Sálamo-Hernández, known as “Concha”, who retired in August 2019. Concha has been an endearing coworker loved by everyone. Concha spent much of her life at the Izaña observatory. Even as a little girl, she spent long periods at the observatory, along with her sister Pili Sálamo, accompanying her grandmother "Maruca" who worked as a cook in Izaña at the time. Concha received a large part of her basic education from employees who worked at the observatory, since at that time transport to such a remote high mountain site was very infrequent (once a month). Since the 1960s and during three decades Concha met numerous famous researchers who passed through the Izaña observatory, such as Christian Jünge, Francisco Sánchez, Joseph Prospero, Rainer Schmitt, Ingeborg Levin, and many others who contributed to forging the bases and the research profile that today characterizes our observatory.

Concha began working as a cook at the Izaña observatory in 1986. Concha is also an example of courage and knowing how to adapt to the new times.

In 1999 she trained enthusiastically to be able to convert her position as a cook into another position as administrative assistant, fulfilling the duties of IARC secretary until her retirement.

In her new professional career in Izaña she fluently handled all the new tools that were appearing rapidly over the years, such as internet, email, word documents, spreadsheets... Concha is our symbol of the transition of Izaña from a modest meteorological observatory, in which it was plunged in the postwar period, to its awakening as a research center. Concha is an example of adaptation to new challenges, and clear proof that great advances and progress are possible if we have the right human factor that believes and participates in that change.

We now wish our former coworker a quiet and happy retirement in the company of her family and friends. We also hope to continue seeing her in celebrations at Izaña that we do when we can. Thank you very much for the work of a lifetime, and for your fellowship. See you soon!



28 List of Acronyms

- ACE-FTS - Atmospheric Chemistry Experiment - Fourier Transform Spectrometry
- ACMAD - African Centre of Meteorological Application for Development
- ACOMET - Meteorology Communicators Association
- ACS - Acute Coronary Syndrome
- ACSO - Absorption Cross Sections of Ozone
- ACTRIS - Aerosol, Clouds and Trace Gases Research Infrastructure
- ADF - aerosol radiative forcing
- ADVS - Adaptive Diurnal minimum Variation Selection
- AE - Angstrom Exponent
- AECID - Spanish Agency for International Development Cooperation
- AEMET - State Meteorological Agency
- AEROCOM - Aerosol Comparisons between Observations and Models
- AERONET - AERosol RObotic NETwork
- AF - Radiative Forcing
- AMISOC - Atmospheric MINorSpecies relevant to the OzoneChemistry at both sides of the Subtropical jet
- AMMA - African Monsoon Multidisciplinary Analysis
- ANN - Artificial Neuronal Networks
- AOD - Aerosol Optical Depth
- APS - Aerosol Polarimetry Sensor
- ARTI - African Residence Time Index
- ATMOZ - Traceability for atmospheric total column ozone
- AQG - Air Quality Guideline
- BBCH - Biologische Bundesanstalt, Bundessortenamt und Chemische Industrie
- BC - Black Carbon
- BDCN - National Climatological Data Base
- BDFC - Barcelona Dust Forecast Centre
- BIRA-IASB - Royal Belgian Institute for Space Aeronomy
- BSC-CNS - Barcelona Supercomputing Centre – National Supercomputing Centre
- BSRN - Baseline Surface Radiation Network
- BTO - Botanic Observatory
- CALIMA - Cloud, Aerosols and Ice Measurements in the Saharan Air Layer
- CAMS - Copernicus Atmosphere Monitoring Service
- CARS - Centre for Aerosol Remote Sensing
- CARSNET - China Aerosol Remote Sensing NETWORK
- CBL - Convective Boundary Layer
- CCD - Charge-coupled device
- CCGG - Carbon Cycle Greenhouse Gases group
- CCI - Climate Change Initiative
- CCLs - Central Calibration Laboratories
- CEILAP - Laser and Applications Research Center
- CEIP - Colegio de Educación Infantil y Primaria
- CEO - Centro de Educación Obligatoria
- CEOS - Committee on Earth Observation Satellites
- CICERO - Center for International Climate and Environmental Research
- CIEMAT - Centro de Investigaciones Energéticas, Medioambientales y Tecnológicas
- CIMO - Commission for Instruments and Methods of Observations
- CINDI - Cabauw Intercomparison campaign Nitrogen Dioxide measuring Instrument
- CMA - China Meteorological Administration
- CRN – Centro radiométrico Nacional (Spain)
- CNR - National Research Council of Italy
- CNRS - Centre National de la Recherche Scientifique
- COST - European Cooperation in Science and Technology
- CPCs - Condensation Particle Counter
- CPT - Cold Point Tropopause
- CRDS - Cavity Ring-Down Spectroscopy
- CRR - Convective Rainfall Rate
- CSIC - Consejo Superior de Investigaciones Científicas
- CWT - Concentration Weighted Trajectory
- DBM - Daumont, Brion & Malicet
- DMN - Direction de la Météorologie Nationale
- DNI - Direct Normal Irradiance
- DOAS - Differential Optical Absorption Spectroscopy
- DOD - Dust Optical Depth
- DREAM - Dust REgional Atmospheric Model
- DSCR - Digital Sky Colour Radiometer
- DT - Dynamical Tropopause
- DU - Dobson Unit
- DVB - Digital Video Broadcast
- EAN - European Aeroallergen Network
- ECC - Electrochemical concentration cell
- ECCC-MS-C - Environment and Climate Change Canada Meteorological Service of Canada
- ECMWF - European Centre for Medium-Range Weather Forecasts
- ECMWF-IFS - European Centre for Medium-Range Weather Forecasts - Integrated Forecasting System
- ECN - Energy research Centre of the Netherlands
- EGVAP - EUMETNET GPS Water Vapour Programme
- EMA - Egyptian Meteorological Authority
- EMPA - Eidgenössische Materialprüfungs- und Forschungsanstalt
- EMRP - European Metrology Research Programme
- Eolo-PAT EOLO-Predicción Aerobiológica para Tenerife
- EPA - Environmental Protection Agency
- EPAU - Evaluación integral del impacto de las emisiones de partículas de los automóviles en la calidad del aire urbano

ERA-Interim – ECMWF global atmospheric reanalysis from 1979

ERDF - European Regional Development Fund

ERIC - European Research Infrastructure Consortium

ESA - European Space Agency

ESA-CALVAL – European Space Agency Calibration and Validation project

ESFRI - European Strategy Forum on Research Infrastructures

ESRL - Earth System Research Laboratory

ETC - Extraterrestrial constant

EU COST - European Cooperation in Science and Technology

EUDAT - European Data Infrastructure

EUMETSAT - European Organisation for the Exploitation of Meteorological Satellites

EURAMET - European Association of National Metrology Institutes

FCS - Fraction Clear Sky

FLEXTRA - FLEXible TRAjectories

FMI - Finnish Meteorological Institute

FNL - Final Analysis Data

FOV - Field Of View

FP7 - European Community’s Seventh Framework Programme

FT - Free Troposphere

FTIR - Fourier transform infrared spectroscopy

FTS - Fourier Transform Spectrometry

FW2 - Fitting Window 2

FW5 - Fitting Window 5

FWHM - Full Width at Half Maximum

GAW - Global Atmosphere Watch

GAW-PFR - Global Atmosphere Watch - Precision Filter Radiometer

GAWSIS - GAW Station Information System

GCOS - Global Climate Observing System

GC-RGD - Gas Chromatography Reduction Gas Analyser

GDAS - Global Data Assimilation System

GELCA - Global Eulerian-Lagrangian Coupled Atmospheric model

GEO – Geostationary Orbit

GEOS-5 -Goddard Earth Observing System model

GFS - Global Forecast System

GHG - Greenhouse Gas

GLOBE - Global Learning and Observations to Benefit the Environment

GLONASS - Global Navigation Satellite System

GMD - Global Monitoring Division

GMES - Global Monitoring for Environment and Security

GNSS - Global Navigation Satellite System

GOA - Atmospheric Optics Group

GOA-UVA - University of Valladolid Atmospheric Optics Group

GOME - Global Ozone Monitoring Experiment

GPS - Global Positioning System

GSR - Global Solar Radiation

HARMONICS - Harmonised Assessment of Reliability of MODern Nuclear I&C Software

HIRLAM - High Resolution Limited Area Model

HUC - Hospital Universitario de Canarias

HYSPLIT - Hybrid Single Particle Lagrangian Integrated Trajectory Model

IAC - Instituto de Astrofísica de Canarias

IAEA - International Atomic Energy Agency

IAMAS - International Association of Meteorology and Atmospheric Sciences

IARC - Izaña Atmospheric Research Center

IASI -Infrared Atmospheric Sounding Interferometer

ICIA - Instituto Canario de Investigaciones Agrarias

ICOS - Integrated Carbon Observation System

ICP-AES - Inductively Coupled Plasma Atomic Emission Spectroscopy

ICP-MS - Inductively Coupled Plasma Mass Spectroscopy

IDAEA - Institute of Environmental Assessment and Water Research

IEO - Spanish Institute of Oceanography

IES - Instituto de Educación Secundaria

IGAC - International Global Atmospheric Chemistry Project

IGACO - Integrated Global Atmospheric Observations

IGN - Spanish National Geographic Institute

ILAS - Improved Limb Atmospheric Spectrometer

IMAA - Institute of Methodologies for Environmental Analysis

IMK-ASF - Institut für Meteorologie und Klimaforschung - Atmosphärische Spurengase und Fernerkundung

INM - Institut National de la Météorologie

INSTAAR - Institute of Arctic and Alpine Research

INTA - Instituto Nacional de Técnica Aeroespacial

IO3C - International Ozone Commission

IPMA - Instituto Português do Mar e da Atmosfera

IR – Infrared

ISAF - Izaña Subtropical Access Facility

IUP - Institut für Umweltphysik / Institute of Environmental Physics

IZO - Izaña Atmospheric Observatory

JRC - Joint Research Centre

KIT - Karlsruhe Institute of Technology

LABEC - Laboratorio di Tecniche Nucleari per i Beni Culturali

LAP - Laboratori d’Anàlisi Palinològiques

LEO - Low Earth Orbit

LIDAR - Laser Imaging Detection and Ranging
 LOA - Laboratoire d'Optique Atmosphérique
 LR - Lidar Ratio
 LSCE - Laboratoire des Sciences du Climat et de l'Environnement
 LUT – Look Up Table
 MAAP - Multi Angle Absorption Photometer
 MARS - Meteorological Archival and Retrieval System
 MAXDOAS - Multi Axis Differential Optical Absorption Spectroscopy
 MBL - Marine Boundary Layer
 MCAR - Mean Concentrations At Receptor
 McIDAS - Man Computer Interactive Data Access System
 MetUN - Met Office Unified Model
 MEE - Mass Extinction Efficiency
 MFRSR - Multi Filter Rotating Shadow-Band Radiometer
 MGA - Modified Geometrical Approach
 MIPAS - Michelson Interferometer for Passive Atmospheric Sounding
 bMIR - Middle Infrared
 MISR - Multi-angle Imaging SpectroRadiometer
 MLO - Mauna Loa Observatory
 MM5 - Mesoscale Model
 MODIS - Moderate Resolution Imaging Spectroradiometer
 MPL - Micro Pulse Lidar
 MSG - Meteosat Second Generation
 MUSICA - MUlti-platform remote Sensing of Isotopologues for investigating the Cycle of Atmospheric water
 NAFDI - North African Dipole Intensity
 NA-ME-E - The Regional Centre for Northern Africa, Middle East and Europe
 NAO - North Atlantic Oscillation
 NAS - Network-Attached Storage
 NASA - National Aeronautics and Space Administration
 NASA MPLNET - The NASA Micro Pulse Lidar Network
 NCDB National Climatological Data Base (AEMET)
 NCEP - National Centers for Environmental Prediction
 NDIR - Non Dispersive
 NEMS - NOAA Environmental Modeling System
 NGAC - NEMS GFS Aerosol Component
 NIES - National Institute for Environmental Studies
 NILU - Norwegian Institute for Air Research
 NIR - Near Infrared
 NIST - National Institute for Standards and Technology
 NMHSS - National Meteorological and Hydrological Services
 NMMB - Nonhydrostatic Multiscale Model on the B-grid
 NMME - North American Multi-Model Ensemble
 NOA - National Observatory of Athens
 NOAA - National Oceanic and Atmospheric Administration
 NORS - Demonstration Network Of ground-based Remote Sensing Observations in support of the Copernicus Atmospheric Service
 NPF - New Particle Formation
 NRT - Near Real Time
 ODSs - Ozone Depleting Substances
 OMI - Ozone Monitoring Instrument
 ONM - Office National de la Météorologie
 OLI - Operational Land Imager
 OSC - ozone slant column
 OT - Ozone Tropopause
 PAR - Photosynthetic Active Radiation
 PFR - Precision Filter Radiometer
 PI - Principal Investigator
 PIXE - Particle-Induced X ray Emission
 PLASMA - Photomètre Léger Aéroporté pour la Surveillance des Masses d'Air
 PM - Particle Matter
 PMOD - Physikalisches-Meteorologisches Observatorium Davos
 POLLINDUST - Studying the dust and pollutants in the Saharan Air Layer
 PSR - Precision Solar Spectroradiometer
 PTB - Physikalisches-Technische Bundesanstalt
 PV - Potential Vorticity
 PWV - Precipitable Water Vapour
 QA - Quality Assurance
 QASUME - Quality Assurance of Spectral Ultraviolet Measurements
 QC - Quality Control
 RA - Row Anomaly
 R&D - Research and Development
 RBCC-E - Regional Brewer Calibration Center for Europe
 REA - Red Española de Aerobiología
 REDMAAS - Red Española de DMAs Ambientales
 RGB - composite - Red Green Blue composite
 RH - Relative Humidity
 RMSE - Root Mean Square Error
 ROLO - Robotic Lunar Observatory model
 RSMC-ASDF - Regional Specialized Meteorological Centre with activity specialization on Atmospheric Sand and Dust Forecast
 RTM - Radiative Transfer Model
 SAF - Satellite Application Facilities
 SAG - Scientific Advisory Group
 SAL - Saharan Air Layer
 SALAM - Air Layer Air Mass characterization
 SAO - Smithsonian Astrophysical Observatory

SAUNA - Sodankylä Total Column Ozone Intercomparison
 SCIAMACHY - Scanning Imaging Absorption Spectrometer for Atmospheric Chartography
 SCO - Santa Cruz Observatory
 SD - Sunshine Duration
 SDM - Standard Delivery Mode
 SDR - Shortwave downward radiation
 SDS - Sand and Dust Storm
 SDS-WAS - Sand and Dust Storm Warning Advisory and Assessment System
 SEAIC - Sociedad Española de Aerobiología e Inmunología Clínica
 SeaWIFS - Sea-Viewing Wide Field-of-View Sensor
 SEM - Standard Error of the Mean
 SHL - Saharan Heat Low
 SMN - Argentinian Meteorological Service
 SMPS - Scanning Mobility Particle Sizer
 SOC - Stratospheric Ozone Column
 SOL - Significant Obstructive Lesions
 SONA - Sistema de Observación de Nubes Automático
 SOP - Standard Operating Procedure
 SPARC - Stratosphere-troposphere Processes And their Role in Climate
 SPC - Science Pump Corporation
 SSDM - Server Meteorological Data System
 STJ - Subtropical Jet Stream
 STS - Sky Temperature Sensor
 STT - Stratosphere-to-troposphere
 SYNOP - Surface Synoptic Observation
 SZA - Solar Zenith Angle
 TNA - Trans National Access
 TOB - Tropospheric Ozone Burden
 TOC - Total Ozone Column
 TPO - Teide Peak Observatory
 TSP - Total Suspended Particles
 TT - Thermal Tropopause
 UAB - Universidad Autónoma de Barcelona
 UFPs - Ultrafine Particles
 ULL - University of La Laguna
 UNEP - United Nations Environment Programme
 UN-GESAMP - United Nations - Group of Experts on the Scientific Aspects of Marine Environmental Protection
 UNIDO - United Nations Industrial Development Organization
 UPC - Universitat Politècnica de Catalunya
 UPS - Uninterruptible Power Supply
 USGS - U.S. Geological Survey
 UTC - Coordinated Universal Time
 UTLS - Upper Troposphere Lower Stratosphere
 UV - Ultraviolet
 UVA - University of Valladolid
 VALIASI - Validation of the EUMETSAT products of atmospheric trace gases observed from IASI using ground-based Fourier Transform Infrared spectrometry
 VIS - Visible
 VMR - Volume Mixing Ratio
 WCC - World Calibration Center
 WCCAP - World Calibration Centre for Aerosols Physics
 WCRP - World Climate Research Programme
 WDCGG - World Data Centre for Greenhouse Gases
 WDCRG - World Data Center for Reactive Gases
 WIGOS – WMO Integrated Global Observing System
 WMO - World Meteorological Organization
 WORCC - World Optical Depth Research and Calibration Center
 WOUDC - World Ozone and Ultraviolet Data Center
 WRC - World Radiation Center
 WS-CRDS - Wavelength-Scanned Cavity Ring-Down Spectroscopy
 WWRP - World Weather Research Programme
 XS - Cross Section
 ZHD - Zenith Hydrostatic Delay
 ZSR - Zenith Sky Radiance
 ZTD - Zenith Total Delay

29 Acknowledgements

An active, enthusiastic and motivated team formed by administrative, technical and scientific staff is the key factor to run a centre like IARC. This report summarizes the activities carried out in 2017-2018, a challenging time period in which there have been significant changes of personnel. This report is an expression of recognition of work done by each and every one of the people working in IARC. We take this opportunity to thank those who have left, for the dedication they showed in their work through many years and wish them all the best in their new positions, and we welcome those who have recently joined IARC.

We are grateful for the strong support to IARC and its activities of the AEMET President (Miguel Ángel López) and, especially to the Director of Planning, Strategy and Business Development (DPEDC-AEMET), Carmen Rus, who has favoured transmitting our scientific proposals to higher levels, in a very efficient way, and has solved with agility and efficiency, numerous technical and human resources needs. We thank Ms Yolanda Berlanga (DPEDC-secretary) for facilitating an accessible and efficient communication between IARC and DPEDC, and assisting us in many ways.

The World Meteorological Organization Global Atmosphere Watch Programme has been an excellent framework within which to develop our activities, where we have always found great assistance and support. The GAW Programme marked its 30th anniversary this year, in 2019. IARC has been contributing to the GAW Programme since it was established in 1989 and we thank the WMO and its associated bodies for their work in coordinating and developing the GAW Programme and for its continuing support to all the IARC activities.

Dr Yolanda Luna, Head of AEMET Department of Development and Applications, has helped us during the reporting period in the administration of R & D projects. We thank Miguel Ángel García-Couto, Head of AEMET Documentation Service, for his support and good ideas in the final publication of this report and other technical publications. AEMET's central library team, headed by Elena Morato, has provided an invaluable help in the use of R & D dissemination tools, and in the incorporation of our research into the ARCIMIS repository.

We express our sincere gratitude to all those institutions, addressed in this report, which work closely with IARC with measurement programmes at Izaña, by means of scientific collaborations, and through international cooperation projects. The exchange of ideas, enabling new research directions and experiences has been very enriching for us.

Back cover photograph: Izaña Atmospheric Observatory
(Photo: Fernando Rey Daluz)

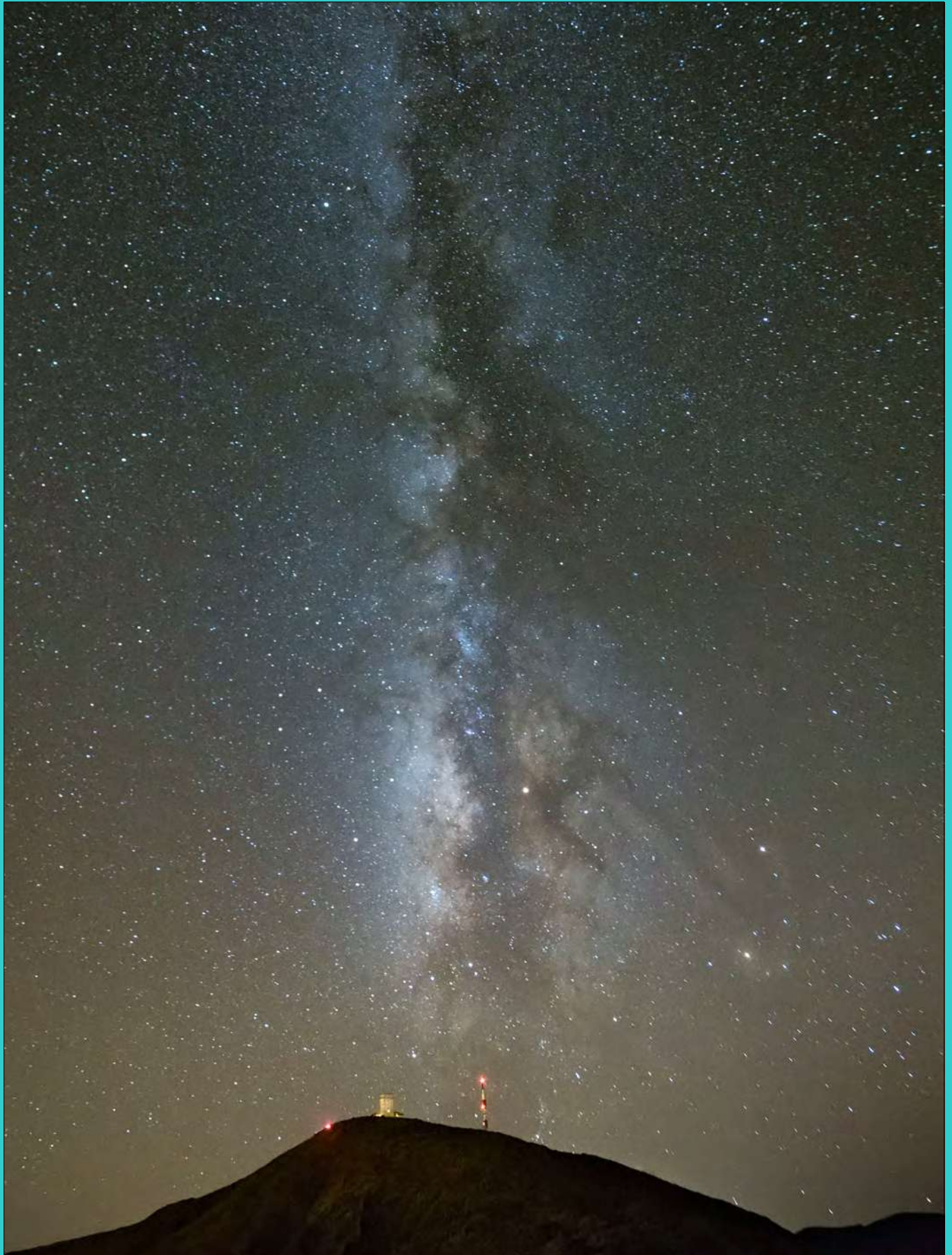

For more information, please contact:
Izaña Atmospheric Research Center
Calle La Marina, 20, Planta 6
Santa Cruz de Tenerife
Tenerife, 38001, Spain
<http://izana.aemet.es>